



WOODWORKING

Leader Guide

The 4-H Motto

“Learn To Do By Doing.”

The 4-H Pledge

I pledge

My **HEAD** to clearer thinking,
My **HEART** to greater loyalty,
My **HANDS** to larger service,
My **HEALTH** to better living,
For my club, my community and my country.

The 4-H Grace

(Tune of Auld Lang Syne)

We thank thee, Lord, for blessings great
On this, our own fair land. Teach
us to serve thee joyfully, With
head, heart, health and hand.

Written by

Elizabeth Webster Goddard M. Agr.

Published by

4-H Section
Alberta Agriculture and Forestry
7000 113 ST RM 200 NW
EDMONTON AB CANADA T6H 5T6

Check out our web site at: <http://www.4h.ab.ca>

No portion of this manual may be reproduced without written permission from the 4-H Section of Alberta Agriculture and Forestry.

TABLE OF CONTENTS

Objectives.....	1
Safety Considerations	3
How Does This Project Work?	5
Planning the Club Year	7
Achievment Requirements.....	9
Resources for Learning	13
Level One: Member’s Manual	
Level One Objectives	15
Achievement Day Requirements	15
Additional Resources	15
Safety: Level One.....	17
Safety Contract (to be signed).....	21
Shop Safety Rules	22
Wood	25
Measurement and Measurement Tools.....	29
Tools	33
Using a Pattern.....	41
Sanding and Finishing	43
Glueing	49
Multiple Choice Test	51
Things to Make.....	53
I Can: Leader’s Signatures	73
Level Two: Member’s Manual	
Level Two Objectives	77
Achievement Day Requirements	77
Additional Resources	77
Safety: Level Two.....	79
Safety Contract (to be signed).....	83
Drawing for Building.....	85
Tools	91
Using Screws as Fasteners.....	101
Measurement Tools	103
Gluing	107
Sanding.....	107
Cutting Angles.....	111
Finishing	113
Things to Make.....	115
I Can: Leader’s Signatures	133
Level Three: Member’s Manual	
Level Three Objectives.....	137
Achievement Day Requirements	137
Additional Resources	137
Safety: Level Three.....	139

Safety Contract (to be signed).....	143
Forestry Industry	145
Drafting, Drawing & Dimensioning.....	147
Joinery	149
Power Tools.....	153
Clamping & Glueing	161
Additional Hand Tools	165
Sharpening of Tools	167
Woodworking Tips	169
Things to Make.....	171
I Can: Leader's Signatures	193



OBJECTIVES

Members will be able to:

- Work safely with wood to produce personal projects made of wood.
- Identify and use woodworking tools and supplies in a safe manner.
- Challenge themselves with variety and varying levels of complexity of tasks in woodworking.
- Work cooperatively with others in a workshop environment.
- Develop skill in decision making, leadership, problem-solving, finances and communication.



SAFETY CONSIDERATIONS

Woodworkers can get so wrapped up in their work that they ignore their personal safety or that of others! 4-H members are no different. No project is worth personal injury or property damage.

Each unit emphasizes safe procedures and the member's responsibility to himself, the club and community. The 4-H woodworking project assumes adult supervision.

Members in all levels are encouraged to identify hazardous situations and to suggest ways to deal with them. Level two members are expected to model safe woodworking techniques. Level Three members are encouraged and expected to model and teach safe techniques.

HOW DOES THIS **PROJECT WORK?**

The woodworking project is organized into three levels of increasing knowledge, skill and challenge. Each project manual has a set of “I can” statements that the member uses to identify and record their progress in the project. E.g. I can measure accurately. I can recommend storage procedures for tools. Leaders can use the I Can statements to determine which level a member should be following.

The manual has:

- learning objectives
- suggested activities
- examples
- questions to ask
- ideas for practice

Some topics may require more than one meeting. Some can be covered together, depending on the characteristics of your members. The members’ manuals are written as self-guiding materials. We hope the members will keep them and refer to them.

Woodworking is a perfect example of Learn to do by Doing. You are helping members develop a life skill that might become a business or wonderful hobby. Your club members will be champing at the bit to get out there and hammer something! The club year will be a mixture of teaching, practice, feedback and fun. Have at it!

PLANNING THE CLUB YEAR

Consider the experience and circumstances of the members and leaders.

- How much woodworking or 4-H club experience do the members have?
- How much woodworking or 4-H club experience do the leaders have?
- What age are the members and what is their attention span?
- How big is the club?
- Where will you meet and what resources do you have there?
- Does every member have the use of a hammer, saw and wood?
- How long and how often will you meet?
- Are adult helpers committed? (Some clubs make it a requirement that each member provides a helping adult at two of the year's meetings.)
- Review the topics in the manual
- Decide which topics you will cover and to what depth. Some topics might require more than one meeting.
- Plan the order of topics.
- Decide what activities you will do for each topic.
- Identify the resources you will need for each topic, including helpers.
- Give a copy of the year's written schedule to each member or family.



ACHIEVEMENT REQUIREMENTS

Achievement Day can be recognition or celebration day if checking work and records is done regularly during the year. A junior leader or parent helper could do the checking of record books.

Many of the requirements for achievement are met during the club year. Record achievement as it happens using the "I Can" chart at the back of member manuals.

Achievement Day Requirements

Level One

- Completed Record Book.
- Make and display a cutting guide and a sanding block.
- At least two projects that you made this year.

Level Two

- Completed Record Book
- At least two projects which demonstrate the use of different finishing techniques and which required use of power tools.
- For one of the completed projects, the plans and a cardboard model of the project.
- Example showing the use of filler and wooden plugs. (If used in member's project, additional examples are not necessary.)
- Example of a mitred corner, either in a project or as a model. (If used in member's project, additional examples are not necessary.)

Level Three

- Completed Record Book
- At least two completed projects which use different types of joints and which required the use of power tools studied in this project.
- Plans drawn by the member for a personal project - cardboard model of intended project.
- Item made by the member that required the use of a router.
- Display of tools sharpened by the member. (Chisels, screwdrivers etc.)

Encouraging Learning

To encourage learning, provide:

Involvement

- mentally
- physically
- emotionally

Relevance

Why is this important?

- today
- in my future

Supportive Relationships

- with leaders
- with fellow members
- with family
- with the community

Structure

- regular meetings
- organized so time is well spent

Reinforcement

- to encourage preferred behaviour
- can come from fellow members as well as adults
- can be a simple smile, nod or pat on the shoulder
- encourage what you would like to see repeated

Repetition

- emphasize key points
- can be pointed out in different ways

Feedback

- answers how am I doing?
- can come from the work itself, members, leaders, family, community

Variety

- in examples used
- in activities chosen
- in teaching methods
- in subjects encouraged

Sequence

- cover the topics in logical order, so that it will make sense to the learners

Practice

- this is Learn to do by doing, not learn to do by talking about it!
- reinforces all the lessons
- speeds learning
- provides feedback
- builds confidence and skill
- gives an opportunity to problem solve
- builds independence

Developing Observation Skills

Many of the senses can be involved in making us better woodworkers. Help member to develop their observation skills.

What can you see?

- textures
- lines
- colours
- flaws in wood
- roughness
- darkness of grain

Flaws

- What can you hear? How can that help you?
- sound of tools. What is normal and what is not?
- sounds of co-workers can alert you to danger

What can you feel?

- textures, smoothness
- temperatures
- dry/wet
- movement
- sharpness/ smoothness
- weight

What can you smell?

- smoke Uh oh!
- power tool heating up
- the wood itself
- the finishes

Building Skills in the 4-H member

- Explain the task and why it is important
- Describe what the member needs to be able to do.
- List steps to the job.
- Show each step.
- Watch as the member completes each step.
- Give feedback. Encourage.

Expectations for Member Growth

We have different expectations for the levels of 4-H members. We expect members to show growth in:

- project knowledge (content)
- correct performance of activities (application)
- working effectively with others (cooperation)
- working independently (independence)

RESOURCES FOR LEARNING

People

- local woodworkers
- teachers
- family members
- other 4-H members or leaders

Places, Events and Organizations

- local woodworking clubs
- exhibitions and fairs that have a woodworking class
- colleges that offer woodworking, design, or similar courses
- displays
- museums sometimes have displays with wooden articles

Books

- ***Workshop Tips and Techniques***. Editors of Cy DeCrosse Incorporated, in cooperation with Black and Decker. Minnetonka, Minnesota: Cy DeCrosse Incorporated, 1991.
- Starr, Richard. ***Woodworking with Your Kids***. Newton, Connecticut: The Taunton Press, 1990.
- McGuire, Kevin. ***Woodworking for Kids***. New York, New York: Sterling Publishing Co., 1993.
- Lento, Robert. ***Practical Woodworking Techniques***. New York, New York: Sterling Publishing Co., 1999.
- Peters, Rick. ***Controlling Dust in the Workshop***. New York, New York: Sterling Publishing Co., 2000.

Magazines

- Woodworkers Journal
- Canadian Home Workshop
- Wood Magazine
- American Woodworker

Web sites

www.thewoodcrafter.net
www.leevalleytools.com
www.woodworkershop.com
www.intheworkshop.com
www.uniqueprojects.com
www.am-wood.com (Amateur Woodworker)
www.northpolechristmas.com
www.tdc.ca/ewebster.htm
www.feesa.ab.ca
www.woodlinks.com

LEVEL ONE: MEMBER'S MANUAL

Objectives

Members will be able to:

- Work safely with wood to produce personal projects made of wood.
- Identify and use woodworking tools and supplies in a safe manner.
- Challenge themselves with a variety of projects and varying levels of complexity of tasks in woodworking.
- Work cooperatively with others in a workshop environment.
- Develop skill in decision making, leadership, problem-solving, finances and communication.

Achievement Day Requirements

Level One

- Completed Record Book.
- Make and display a cutting guide and a sanding block.
- At least two projects that you made this year.

Additional Resources for Learning

People

- local woodworkers
- teachers
- family members
- other 4-H members or leaders

Places, Events and Organizations

- local woodworking clubs
- exhibitions and fairs that have a woodworking class
- colleges that offer woodworking, design, or similar courses
- displays
- museums sometimes have displays with wooden articles

Books

- ***Workshop Tips and Techniques***. Editors of Cy DeCrosse Incorporated, in cooperation with Black and Decker. Minnetonka, Minnesota: Cy DeCrosse Incorporated, 1991.
- Starr, Richard. ***Woodworking with Your Kids***. Newton, Connecticut: The Taunton Press, 1990.
- McGuire, Kevin. ***Woodworking for Kids***. New York, New York: Sterling Publishing Co., 1993.
- Lento, Robert. ***Practical Woodworking Techniques***. New York, New York: Sterling Publishing Co., 1999.
- Peters, Rick. ***Controlling Dust in the Workshop***. New York, New York: Sterling Publishing Co., 2000.

Magazines

- Woodworkers Journal
- Canadian Home Workshop
- Wood Magazine
- American Woodworker

Web sites

www.thewoodcrafter.net
www.leevalleytools.com
www.woodworkershop.com
www.intheworkshop.com
www.uniqueprojects.com
www.am-wood.com (Amateur Woodworker)
www.northpolechristmas.com
www.tdc.ca/ewebster.htm
www.feesa.ab.ca
www.woodlinks.com

SAFETY: LEVEL ONE

Objectives

Members will be able to:

- Identify risks.
- Demonstrate safe behaviours
- Teach others about woodworking safety
- Take preventative steps to avoid injury or damage.

Before the Meeting

- Review safety contract.
- Prepare for Hazard Hunt, if you are having one.
- Assemble examples of safety equipment related to woodworking.
- Draw “Who does an unsafe worker affect?” on flip chart or large piece of paper or cardboard.
- Have in mind some safety rules for the club to add to those that the members suggest.

At the Meeting

- review the importance of safety in woodworking
- ask members to complete the “Who does an unsafe worker affect?” page and complete the large page you prepared.
- have members identify risks and suggest preventative action
- review and complete safety contracts. Ask members to get their parents to review and sign.
- conduct a Hazard Hunt or other safety activity.
- fit everyone with their safety goggles, dust protection etc.
- members suggest safety rules for the group.

Alternative Activities

- demonstration of how to use a fire extinguisher
- First Aid demonstration
- clean up the leader’s shop! (That’s always popular!)
- introduce a new tool or piece of equipment, with emphasis on safe use

Safety in the Woodworking Project

List as many preventative actions as you can for the following risks:

AT RISK	RISK	PREVENTATIVE ACTION
EYES	Flying chips Dust Splashing finishes Splinters from breaking tools Fumes Compressed air used improperly	
EARS	Exposure to loud noises	
LUNGS	Exposure to very tiny dust particles (less than 10 microns) Exposure to fumes from finishes Inadequate ventilation	
SKIN, FINGERS, LIMBS, HANDS AND FEET	Punctures, rips from tools and rough wood. Crushing Pinching Exposure to chemical finishes Abrasions Burns from hot tools	
BACK	Lifting too much Falls from tripping over materials Turning incorrectly Lifting incorrectly	

You must purchase your own personal safety equipment for the 4-H woodworking project. Eye protection must be worn.



Who does an unsafe worker affect?

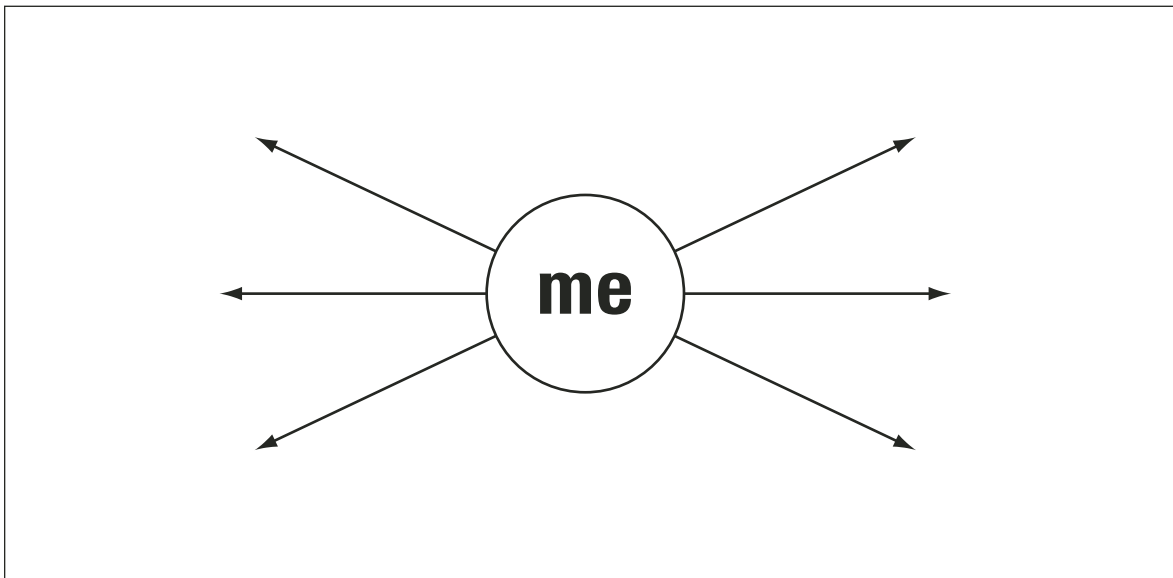

Safety Steps

1. Name the risks.
2. Safeguard the work area.
3. Wear necessary protective equipment.
4. Use the right tools.
5. Follow correct procedure.
6. Monitor work habits.
7. Correct as necessary.

Ensure all helpers follow safe procedures

- Where are the First Aid kits kept at your 4-H meetings?
 - Where are all the First Aid kits at home?
 - Who has First Aid training in your 4-H club?
 - Who has First Aid training in your family?
 - What phone number do you call for emergency help?
 - What are the directions to drive to your meeting place? (In case you ever had to give them to emergency people)
 - What are the directions to get to your home? (In case you ever had to call emergency people)
- Post these by all the phones in your home or shop.

Contents for a Basic First Aid Kit

A variety of bandages; antiseptic; tweezers; First Aid booklet; cotton swabs; sterile gauze; First Aid tape; needles (to get out slivers); eye drops.

Safety Word Search



ABRASION
ATTENTION
BANDAID
BRUISE
CONDITION

ELECTRICAL
FINGER
HAMMER
HORSEPLAY
POWER

PROTECTIVE
PUNCTURE
SANDER
SCRATCH
SURPRISE

TELEPHONE
TOE
VARNISH
VENTILATION
WRAP

SAFETY CONTRACT

I Will:

- identify risks of activities
- take actions to eliminate or reduce risk
- ask for help when needed
- select the correct tools, equipment and materials for activity
- watch for and allow for closeness to other people
- stop work and move back when ask to
- exit work area on command (in case of emergency)
- return tools and supplies to storage after use
- follow safe disposal procedure
- dress appropriately for club activities
- share responsibility for safety in the club

Member

Parent

Leader

Date

Safety Logos

Flammable



Explosive

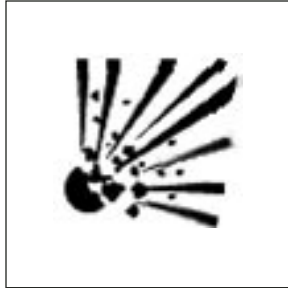

Crushing Hazard



Electrical Hazard



Poison



Ventilation Required



Hazard Hunt (Things to look for)

1. General tidiness of work area. Is everything in its place or is there a jumble of things to trip over?
2. Is wood stored so that it will not fall on someone?
3. Are tools in good condition?
4. Safety equipment available and appropriate to tasks? (Eye protection, hearing protection, dust protection etc.)
5. Fire equipment available and ready to be used?
6. Is ventilation appropriate?
7. Are there trash cans for wood scraps and other waste?
8. Is lighting adequate?
9. Is work surface smooth and free of snags?
10. Are chemicals stored safely?

My suggestions for improvements: List three

WOOD

Objectives

Members will be able to:

- identify parts of wood
- recognize at least two types of wood
- tell the difference between hardwood and softwood
- list characteristics of wood

Prepare for the Meeting

- assemble examples of types of wood (rough to finished)
- gather samples of 4-H projects of previous years
- gather examples of warped wood, split wood, wood with dry rot, wood with knots, twisted wood
- plan for a tour, if you are doing one. Invite the local paper to do a story on your 4-H club's tour?

Activities at the Meeting

- examine samples that you have assembled
- members can show and explain about projects from previous years (why they choose that type of wood; how difficult it was to work on it etc.)
- members label picture of wood in their manuals
- look at wood under a microscope? (Dry wood and wet wood?)

Alternative Activities

- tour a lumber yard or a woodworker's shop
- view pictures of historic wooden features in North America and Europe or Asia
- select wood for personal projects

Wood is a versatile and challenging material that is readily available to us. It is relatively easy to shape and it can be grown and harvested like other crops. The forestry industry has played an important role in Canada's history and economy.

If properly cared for, wood will last for thousands of years! The more you know about it, the better you will be at using it.

Wood is made of cells, which can swell when they absorb moisture, and then shrink when they dry. The cells swell and shrink across their diameter much more than along their length. This explains why wood will expand and contract more across the grain than it will from end to end.

Wood also tends to split parallel to its fibres. When people are splitting firewood, they always split it parallel to the log's length (or else they are out there a really long time!).

Trees grow a new layer of wood under the bark each year. We call these layers annual rings.

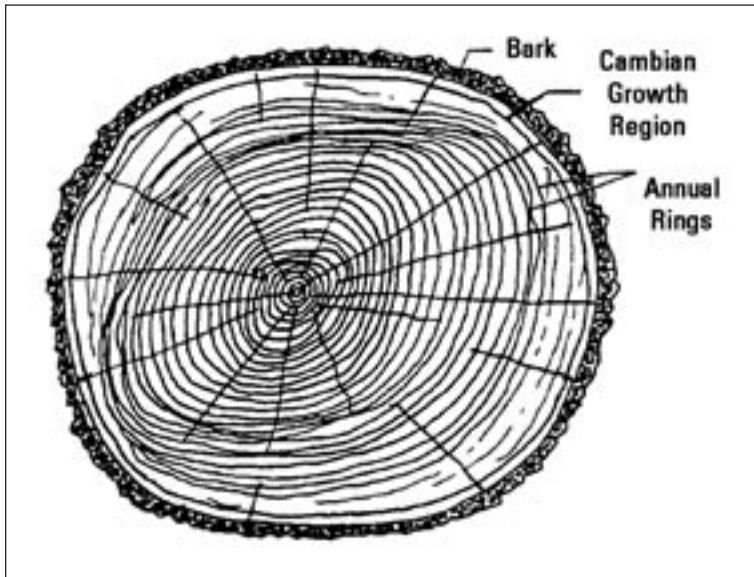

You can count these rings on a log or stump and figure out the actual age of the tree. Foresters are able to calculate the approximate age of trees without felling them with a tool called an increment borer.

When a tree is cut into planks, the pattern of these annual rings produce what we call grain in the wood. Each type of wood has its own special grain. Woodworkers can identify most woods by their grain. You will learn this skill too.

Different types of trees have different colours of wood. Experienced woodworkers can identify many woods by their colours. Woodworkers enhance these natural colours by applying various finishes.

Wood has natural defects. The knot is the most common one that woodworkers have to deal with. Knots form where tree branches grow. Knots can be quite hard. If you hit them with a nail, the nail will often bend or bounce off. Knots also absorb finishes differently than the rest of the wood. If possible, avoid wood with knots for your projects.

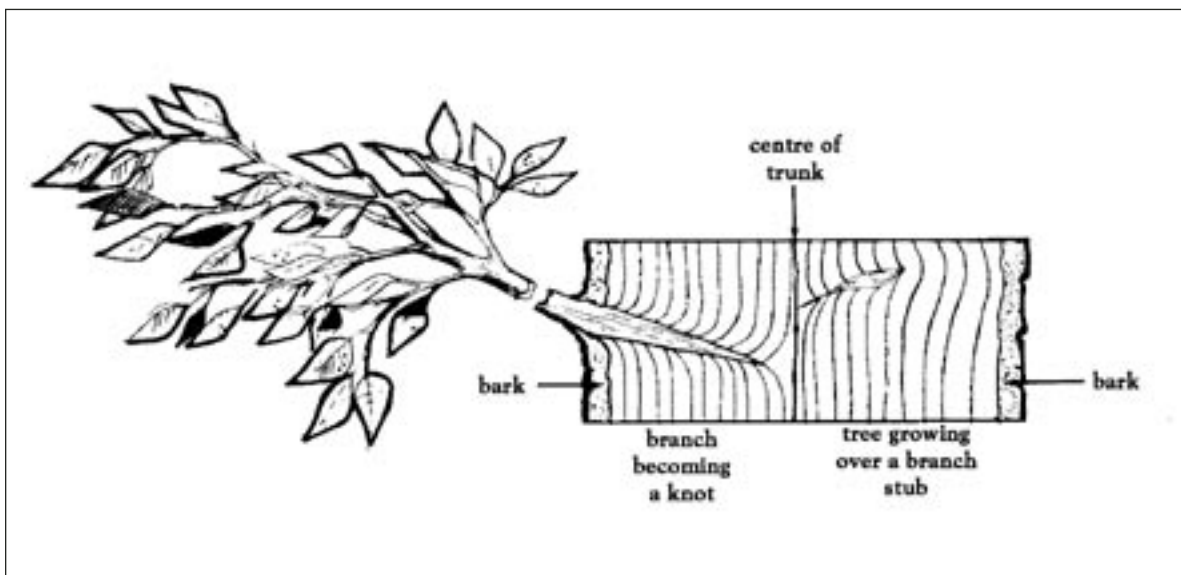

Warping is the bending of wood as it gains or loses moisture. Wood can warp in many directions. When selecting wood for your project, check for warping wood and avoid it.

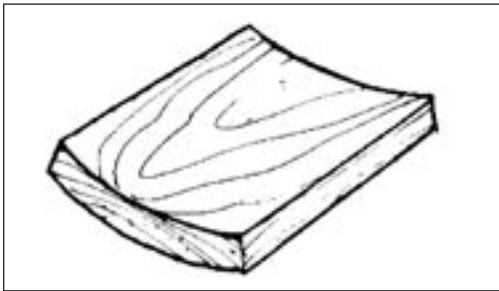

Wood comes in various grades. The higher the grade, the more expensive the wood.

Hardwoods come from trees with broad leaves and which produce seeds from true flowers. Hardwoods include oak, elm, maple, cherry and teak. Softwoods come from trees with needles that produce their seeds in cones. Softwoods include pine and fir. Softwoods are less expensive than hardwoods. Most beginning woodworkers start with softwoods.

MEASUREMENT & MEASUREMENT TOOLS

Objectives

Members will be able to:

- recognize and explain the difference between the metric and Imperial measurement systems
- identify measurement tools
- give best use of ruler, measuring tape, try square
- accurately measure and cut wood

Prepare for the Meeting

- assemble the measuring tools you will use
- assemble wood for members to measure
- ensure members have paper and pencils

Measurement

Measure Twice. Cut Once

Measurement is one of the most important tasks done in woodworking. In rough carpentry, tolerances of 1/8 inch (mm.) would be allowed. In cabinetwork, the minimum tolerance should not be more than 1/16 inch (Lento, Robert. Practical Woodworking Techniques.).

Officially Canada switched to the metric system in the 1970's, but the lumber industry did not. Changing over to the metric system would be very expensive and awkward and so lumber terms and measurements are often given in Imperial.

The common board used for construction in North America is the 2 by 4". However, it actually measures 1 ½ by 3 ½ inches, or 88.9 mm by 38 mm! When you are measuring for your woodworking, choose one measurement system and stick with it!



It is important to choose one system and stick with it for a project for these reasons:

Why is it important to be accurate and consistent in measuring for woodworking projects?

Measurement Tools

Measuring Tapes

Measuring Tapes. These come in various sizes, colours and lengths. They are very handy and can even measure a curved surface. The tip of the measuring tape must be securely fastened, or it will give an inaccurate measurement.

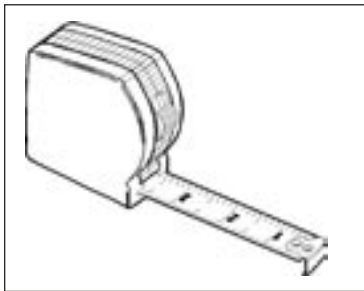

For woodworking purposes, we recommend a measuring tape with both metric and Imperial measurement, as you will see many drawings and plans in Imperial measure. (Especially free project plans from web sites!)

Try Square

This tool looks like a ruler with a handle attached at a right angle (90 degrees).

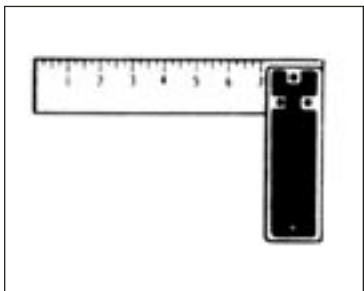

It is used to test if two surfaces are at 90 degrees. This is really important because most woodworking projects assume that parts are square to each other.

- Use a try square to see if the end of a board is square (cut at right angles to the boards edge).
- Use a try square to mark a new end of a board if the first one is not square.
- Use a try square to mark a square line for a project piece.

Combination Square

This has several uses: to check if a board is flat; to check for levelness; to check angles; to measure depth; to lay out a line parallel to the edge of a board.

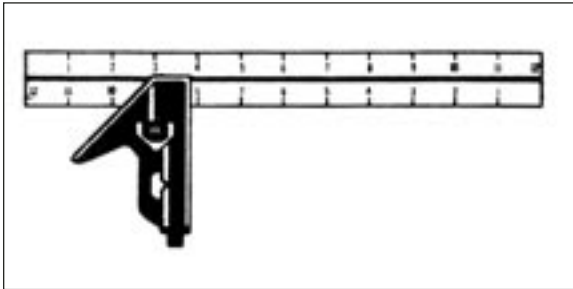

Care of Measurement Tools

Tips about Measuring.

- Never measure when you are tired, angry or really hungry! Those are times when people make lots of mistakes! Take a break, then come back to it.
- Make a cardboard model of your project first.
- Use a long tape or ruler when measuring. (Rather than adding up several measurements from a small tape or ruler.)
- Mark the waste side of a cut with an X.

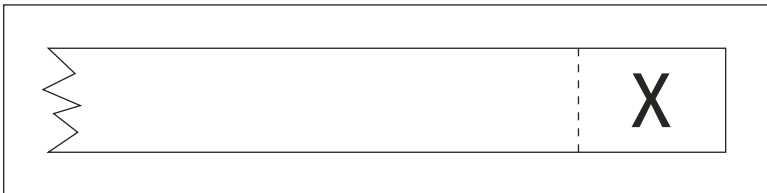

- Cut on the waste side of a cutting line. The saw cut (kerf) uses up part of the wood and could make your good piece of wood too small for the project.
- Do not mark all your measurements on a board at once. Each cut will take off the width of the saw cut (kerf) and it is too tricky to try to figure that in, when measuring ahead of time.
- Double check your measurement before cutting.

Practice in Measurement

Supplies

Several small rectangular pieces of wood, table or similar piece of furniture, tape measures, small rulers, pencils, paper.

Procedure

- Choose a piece of wood. Measure it accurately, using both the measuring tape and the ruler.
- Make a quick drawing of the piece of wood and note its measurements on a piece of paper.
- Have your group leader check your results.
- Which tool did you prefer for measuring this piece of wood, the tape or the ruler?
- Choose a table, bookcase, or other structure with rectangular or square shape. Measure one surface, draw it and note its measurements on the drawing. Use both your measuring tape and a ruler.
- Have your group leader check your measurements.

Which tool did you prefer for measuring this time? Why?

What did you do to ensure your measurements were accurate?

Practice Using a Try Square to Mark a Line on Wood

Supplies

A piece of wood 30cm long and 20 cm wide (approx.); tape measure; straight edge; sharp pencil; try-square

Procedure

- Hook the end of the tape measure on one end of the wood and extend it to the other end of the board. Lock the tape measure.
- Hold the tape straight with one hand. Mark the wood at 15 cm and at 20 cm , exactly.
- Use the straight edge to draw a line as straight as you can at the 15 cm mark.
- Place the calibrated side of the try square at the 20 cm mark, with the other side of the try square snug against the edge of the board. Draw a line across the board at the 20 cm mark (parallel to the first line drawn at the 15 cm mark).
- Which line looks straighter? (Which line looks like it is at 90 degrees to the edge of the board?) It should be the one drawn with the try square.

Practice at Home

- Practice measuring and drawing various objects around home, using both your tape measure and a ruler. Show your drawings to someone to see if they can understand and follow them easily.
- Practice drawing lines across scrap wood using a try square. Remember to keep the try square snug up against the edge of the board.



TOOLS

Objectives

Members will be able to:

- identify common woodworking tools and their proper use.
- recommend handling and storage to protect tools
- safely use tools to build projects
- use appropriate safety equipment

Prepare for the Meeting

- assemble examples of each type of tool (borrow if necessary)
- make sure each member will have a hammer to use
- provide scrap wood for members to hammer nails into
- supply wood putty

At the Meeting

- review each tool in turn, describing its features, use, care and handling, safety
- demonstration of how to hammer by older member?
- allow for practice by members
- hammer practice by members. Encourage accuracy, rather than speed!
- nail straightening and pulling by members
- use of nail set by members
- how to/not to use a rasp
- examples of protective covers for a saw
- storage tips for tools
- how to label your tools

Hand Saws

Hand saws have a metal blade with teeth and a handle made of wood or plastic. The teeth cut a path (kerf) through the wood. Saws have set teeth. This means that the teeth are bent alternately from side to side, so that the kerf is wider than the actual saw. This helps prevent the saw getting stuck when cutting wood.

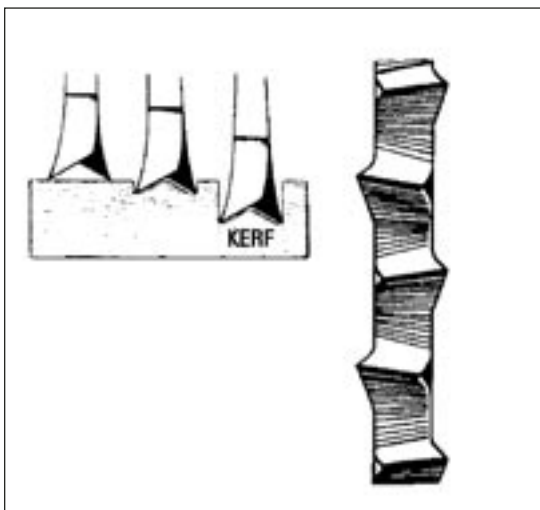

Common Saw

Has about eight teeth per inch (2.54 cm.). Use this saw to cut across the grain of a board.

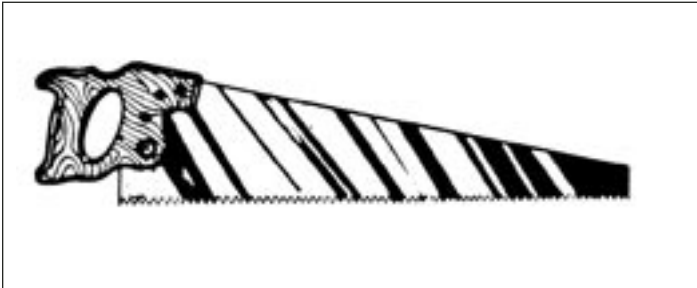

Rip Saw

Has half as many teeth than the common saw. Use the rip saw to cut along the length of a board.

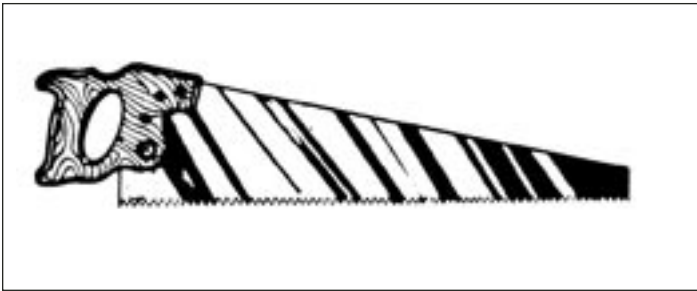

Backsaw (Mitre Saw)

A rectangular blade, with a stiffening metal strip on the top edge. Used with a mitre box to cut exact angle cuts.

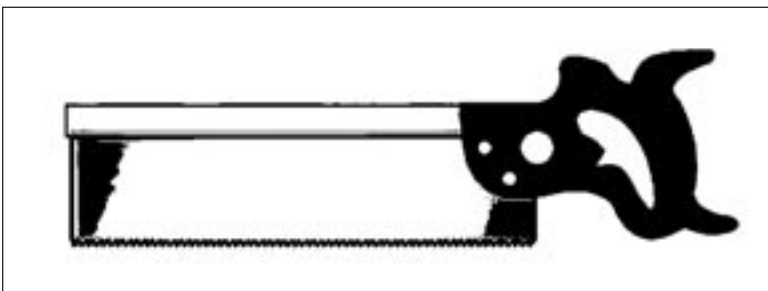

Frame Saw

Used for making curved cuts. A frame holds the fine blade firmly. The coping saw is the most common type of frame saw.

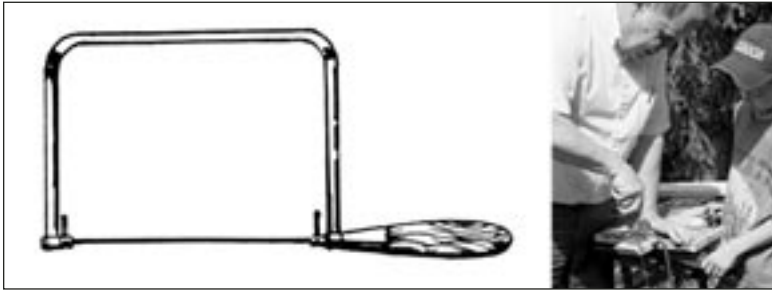

Rasp

Woodworkers use rasps to shape wood and smooth rough surfaces. Rasps look like a coarse file with a handle on one end. Rasps quickly remove excess wood with their coarse teeth. A rasp only removes wood as it moves forward. Pick it up and lift it back to the start, to take another stroke. Rasping is done before sanding.

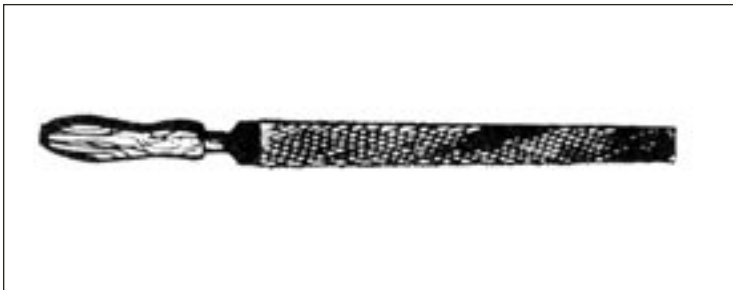

Nails

Nails come in different sizes and materials. Nails work by pushing wood fibres aside. The wood fibres then push back against the nail and help keep it snug. A nail driven into the edge or face of a board will hold better than a nail driven into the end of a board. The larger and rougher the surface of a nail, the better it holds the wood.

Common Nails

These have quite a big head and are quite thick.

Finishing Nails

These have a smaller head than a common nail and are thinner. Finishing nails are usually set into the wood, then the hole is covered up with putty, so that it does not show.

Sizing of Nails

The sizes of nails are referred to as penny size. The short form for penny is d. A 1 ½ inch nail is written as a 1 ½ d nail.

Nails that are shorter than two inches in length (5 cm) are sized in fraction of an inch and the wire-gauge size. Wire gauge sizes include # 17, 18, 19 and 20. These numbers are written on the bins or boxes in which you find nails at the hardware store. Most plans tell you what size and number of nails to use. If confused, explain what you are building and the store employee should be able to recommend the size of nail.

Nail Set

A nail set is used to push the head of a finishing nail or brads into the wood a bit further, so that the hole can be covered up with putty. A nail set looks like a fat spike with a flat ends. Nail sets come in different sizes, to fit the different sizes of finishing nails.

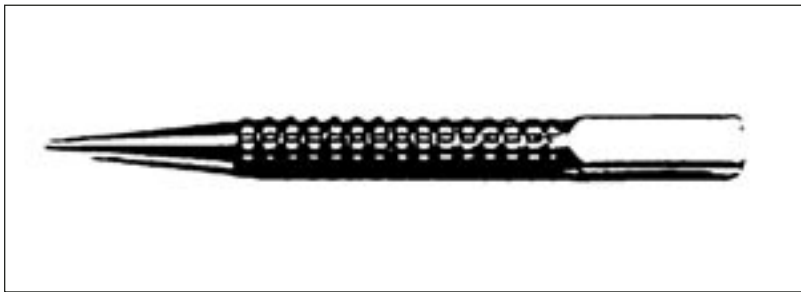

Hammer

Use your claw hammer to drive and remove nails. Don't let anyone use it for anything else! Hammers come in a range of sizes and shapes. Choose the weight that feels right for you. Hammers come with wooden, metal or fiberglass handles. The best hammer heads are forged steel. Mark your name and phone number on your hammer somewhere.



Safety Tips for Hammering

- Make sure the hammer head is secure.
- Wear eye protection.
- Secure long hair so it does not get caught in the passing hammer.
- Make sure the hammer head is clean.
- Use your woodworking hammer only for woodworking.
- Hold your hammer at the low end of the handle when using it.
- Watch out for other people when using your hammer.
- Keep the head at right angles to the surface you are driving the nail into. This will keep the nail from bending.
- If you have to pull out a long nail, put a block of wood under the hammer head. This gives you better leverage and will also prevent breaking off the handle.
- When you set your hammer down, make sure the entire hammer is out of the way, so people will not accidentally knock it off the surface.
- Start your nail with a couple of taps, then move your fingers away from the nail.

Tip: To hold a nail in a tiny spot, thread a doubled string through a drinking straw. Poke the nail through the loop, then tighten the string to hold the nail.

Tip: Nails go into dry wood more easily if they have been dipped in a bit of wax. You can drill a small hole in the end of your hammer and fill it with melted paraffin, so the wax is always handy for you!

Driving Nails (how to hammer)

- Choose the right hammer for the job. Use a smaller hammer for small nails and a heavy hammer for larger nails.
- Hold the nail in the right spot with one hand.
- Swing the hammer from your wrist. Tap the nail lightly so that it will stick in the wood by itself. Once it sticks into the wood by itself, take that holding hand away. This is important. (As the makers of bandaids will tell you.) Use that hand to steady the board as you hammer.
- Hold your hammer at the lower end of the handle (away from the metal head). This will give you a better swing and make better use of your energy.
- Use your whole arm for the most power. This will come with experience.
- Keep the handle of the hammer at a 90 degree angle to the nail while driving. This will help the nail go into the wood in a straight line and not bend.
- Keep your eyes on the nail. Hit the nail squarely on the head. Your skill at this will increase with practice.
- Try to avoid hitting the wood itself, so you do not dent the wood.
- Once the nail is completely into the wood, stop!



To Start a Nail

Sometimes wood is so hard, that it is difficult to start a nail into it. This can be frustrating. Here's a way around the problem.

- Clamp the two pieces of wood together securely.
- Mark the spot for the nails with a scratch awl or a pencil.
- Drill a pilot hole with a drill bit slightly smaller than the nails you are using.
- Tadah! Nail away!

Using a Nail Set

- Choose a nail set that matches the size of the head of the nail you want to work on.
- Hold the nail set on the head of the nail.
- Gently but firmly tap the nail until it is just under the surface of the wood.
- Now you will be able to fill the hole with putty, so that the nail will not show. After the putty dries completely, you will sand it smooth.

Bent Nails

Bent nails are very common. Try to straighten them to prevent waste. Hold a block of wood against the nail and then tap the nail repeatedly against the block. Don't try to straighten it all in one swing, unless it only has a very small bend. Sometimes you can straighten a short nail without the block.

Pulling Nails Out

You will remove nails from projects or from old structures many times in your life. Here's how to do it.

- If you have enough room, place a flat block of wood between the hammer head and the good piece of wood. This protects the wood and will also give you better leverage.
- Make sure the head of the nail is snug in the V of the claw of the hammer. Otherwise, you can pull off or mangle the head of the nail.
- Pull smoothly; do not jerk the nail. Put the discard nails in the bin.



Removing Dents

Occasionally you will dent wood. Some small dents will come out with steam. Use a moist cloth and an iron over the dent for a few seconds.

USING A **PATTERN**

Objectives

Members will be able to:

- explain the benefit of using a pattern
- select a pattern appropriate to skill, resources and interest
- redraw a pattern
- read a pattern
- trace a simple outline on wood
- list sources for project patterns.

Prepare for the Meeting

- gather a variety of patterns and, if possible, items made from those patterns
- gather examples of pattern sources
- ensure there will be paper, pencils and tracing paper for members
- provide photocopies of patterns and iron
- provide scraps of wood for practice

Activities

- members compare patterns and projects made by members from other years
- members copy patterns by hand
- members transfer patterns by tracing
- members transfer patterns using a photocopy and iron
- members select or research patterns for their projects

You can find patterns in woodworking books, magazines or web sites. For simple projects, you can outline a picture.

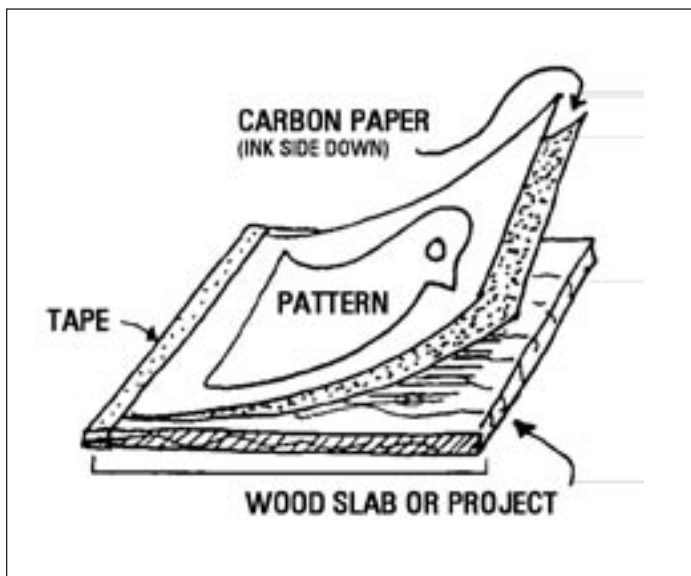

Supplies

Small piece of wood (30cm by 30cm); pattern or drawing that will fit on the wood; carbon paper; dulled pencil; masking tape.

Procedure

- Tape one side of the pattern to the wood, so that it will lift like a flap. Line the pattern up so it is right where you want it.
- Put the carbon paper under the pattern, with the carbon side against the wood.
- Using the dulled pencil trace along the lines of the pattern, pressing firmly. (A sharp pencil would cut the pattern.)
- Lift the carbon paper up to make sure the pattern is marking properly.
- Lay the paper and pattern back down, tape in a few more places, and continue tracing.
- When you are done, you can cut this out, paint or carve or wood burn it!

This is a great technique to use for making various crafts you admire!



SANDING & FINISHING

Objectives

Members will be able to:

- explain the purpose and value of sanding
- list and demonstrate the steps of sanding
- indicate the direction of grain in wood
- list steps to manage dust
- select, use and clean sandpaper
- explain purpose and value of finishing
- select an appropriate finish for projects
- identify safety risks with finishing materials
- apply finishing techniques to a project

Prepare for the Meeting

- gather examples of wood in various stages of sanding and finishing
- gather examples of different grits of sandpaper
- gather wood for members to practice sanding
- gather examples of finishing materials

Suggested Activities

- blindfolded members sort grits of sandpaper from coarse to ultrafine
- blindfolded members sort examples of wood by degree of sanding or finishing
- members compare hand sanded articles to machine sanded articles
- members compare and test types of personal dust protection
- members make a personal sanding block
- members clean up dust!
- demonstration of finishing techniques
- practice of finishing techniques on wood samples

Alternative Activities

- members make a display that shows the stages from rough wood to final product along the length of one piece of wood
- on tours of woodworking shops, pay attention to the dust management systems and procedures in place

Sanding

We sand wood to smooth the rough edges and scratches left by cutting it. Sanding also makes a project look and feel to be better quality.

Sandpaper is gritty material glued onto paper. It comes in a range of coarseness. Use coarse sandpaper when starting to sand a project. Use finer sandpaper when you are getting to the final stages of sanding.

Sandpaper coarseness is expressed as grit. The lower the number of grit, the coarser the paper. The higher the number, the finer the grit. For example, 80 grit sandpaper is much coarser than 120 grit sandpaper. The grit number is printed on the back of the sandpaper. Many project plans will suggest what grit of sandpaper to use.

Sandpaper comes in standard sheet sizes of 22cm by 28cm. We divide these sheets into four pieces to use in a sanding block. Don't ever use your scissors to cut sandpaper it will dull the blades and the scissors owner will never let you forget it! Who needs that?

Fold the sandpaper in half, with the grit side out. Crease it on the fold. Slice it on the paper side with a knife. Fold the two halves. Cut them again. You will have four pieces of sandpaper to use in your hand-sanding block.

Before you use your sandpaper, roll the paper, grit side out, to break up the glue on the paper a bit.

Tap sandpaper on the back to clear dust.

Wipe your work off with a lint-free cloth.

Hand Sanding Block

Use a hand-sanding block to make the best use of your sandpaper. A sanding block helps you put even pressure on the wood you are sanding. This prevents you making grooves in your project with the sandpaper.

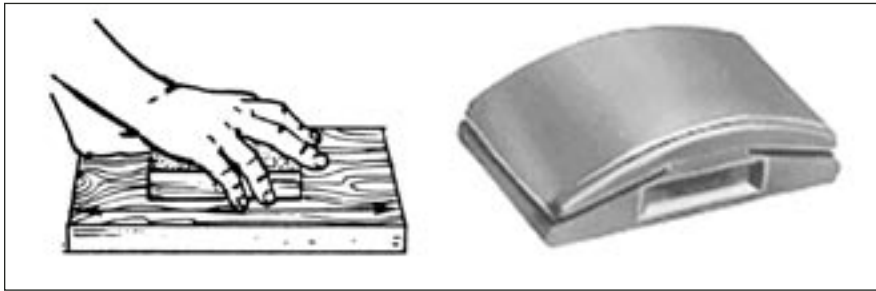

You can either make or buy a hand-sanding block. A hand-sanding block is a piece of wood about 2 cm by 11 cm by 12 with a bit of carpet or rubber glued to the bottom. The sandpaper is held against the carpet or rubber so there is a bit of give when sanding.

Wrap the sandpaper around the bottom of the block of wood (paper side against the carpet or rubber) and hold it on with your fingers. Start sanding with your coarser grit sandpaper and finish with your finer sandpaper.

Always sand with the grain. If you don't, you will scratch the wood. And that does not look good. On the edges of the wood, sand along the edge.

Sanding Tiny Pieces of Wood

Glue some sandpaper onto a piece of plywood. Hold your small piece of wood and rub it against the sandpaper, rather than rubbing the sandpaper against the object.

Dust Management

Sanding produces very fine dust particles. It is the smallest dust particles (the ones that are too small to even see) that can cause the most damage to the lungs of woodworkers. Dust particles less than 10 microns are the most dangerous because they can get into the alveoli of the lungs. To give you an idea of size, a human hair is approximately 100 microns in diameter.

Dust Protection

Nuisance Filters

Nuisance filters (disposable paper filter masks) do not filter out particles smaller than 10 microns, the dangerous size. It is almost impossible to get a good seal with these masks.

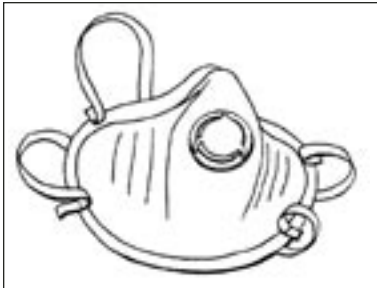

Reusable Respirators

Reusable respirators provide a good seal against the face and the filters can be replaced when dirty. They filter out the smaller particles. A good fit is crucial for a respirator to work properly.

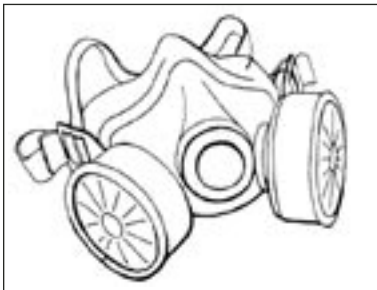

Finishing

When finishing a project, it is very important to work in a dust free area. Otherwise, your project will have dust and hair etc. stuck all over it!

We finish a wood project to protect it and to improve its appearance. Finishes either penetrate the wood or sit on the surface.

- Choose a finish according to the appearance of the wood and how the project will be used.
- Use rubber or latex gloves to protect your skin.
- Provide adequate ventilation.
- Rags or steel wool damp with oil can combust so put in a bucket of water or a metal container with a tight lid (outside).
- Dispose of any leftover products according to local laws and with respect of the environment.

Penetrating Finishes

Stains and preservatives soak into the wood fibres so that you can still see the grain and also feel the wood. To remove stain or preservative, you have to actually remove the wood fibres they have penetrated.

Penetrating oils include linseed, tung, teak, Danish and polyurethane oils. Oil alone will darken wood. Penetrating oils are easy to maintain but are not as tough a finish as others.

Surface Finishes

Paint, varnish, shellac and lacquer are surface finishes. Varnish, shellac, lacquer are clear and allow you to see the grain of the wood. Paint has colour and hides the wood.

Using Penetrating Finish (for inside use only)

Supplies

Safety glasses, lint free cloths, good quality small paint brush, finish, 340 grit silicon-carbide paper or 0000 grade steel wool, rubber or latex gloves.

Procedure

- Brush a coat on the surface. Make sure the grain is evenly wet.
- Rub in the oil. First use a circular motion, and then change it to follow the grain.
- Let it dry. (Check the container for proper length of time.)
- Lightly sand with the paper or steel wool.
- Apply more coats (1 to 3 more is average), lightly sanding in between, until you are satisfied with the finish.
- After the final coat, use a small piece of steel wool to give the surface a fine sheen.
- Rub briskly with a soft, clean cloth.

How To Stain

- Read the instructions for applying oil. Stains apply in a very similar fashion.
- Use a cloth for small items, and a brush for larger projects.
- Read the container for drying times.
- Does your stain require a protective coat? Read the container for suggestions about compatible protective coats.

How to Varnish

- Prepare the wood finish. It must be clean and smooth. If necessary, fill any holes and cracks. To clean, wipe with mineral spirits.
- Brush varnish against the grain. Then, brush diagonally. Then, brush with the grain.
- When completely dry, use fine silicone-carbide paper to smooth the finish.
- Repeat with another layer or two of varnish, until you are satisfied with the result.

How to Paint

Supplies

Newspaper, paint, clean paintbrush, old clothes to wear, something to paint, cleaning solvent.

Procedure

- Protect your work surface with newspaper.
- Mix your can of paint. (If you just bought it, they will offer to shake it for you. Shaking can cause bubbles in your topcoat.) Make sure it is well mixed, right to the bottom of the can.
- Make sure the object you are painting is clean and free of dirt and grease, or the paint will not stick well. If necessary, clean the surface with mineral spirits.
- Dip only the tip of the brush into the paint (no more than 1/3 of the brush.)
- Start painting in the corners and work out from there. Paint the flat, easy bits last.
- Brush the paint with the grain in easy strokes. Keep going until the paint starts to get too thin.
- Redip your brush and continue.
- Do not put too much on at once. Sometimes you have to let the first coat dry and apply a second coat.
- If painting two colours next to each other, let the first colour dry completely before starting the second coat. Be patient!

Clean up after Painting

- Clean up immediately after finishing your painting. The longer you leave it, the harder the job will be.
- Rub the brush against the side of the can to squeeze out excess paint.
- There will probably be paint in the groove on the top of the can. Scoop this out and scrape it back into the can. The lid will fit on better this way and your paint will not dry out.
- Check on the can about cleaning procedures. Follow those instructions.
- Most paints you will use for these projects require a solvent for clean up. Paint thinner works as a solvent. Pour a bit of solvent into a clean can and swish the brush in it. You may have to change the solvent a few times until the brush appears to be clean.
- Tap the brush to get rid of the excess solvent. Brush it on dry newspaper until it appears dry.
- Dispose of the solvent soaked papers in metal container with lid, outside any building. Solvent soaked rags can burst into flames by spontaneous combustion.

Cleaning your Hands

Put a bit of paint thinner on a cloth or paper towel and rub on paint spots until they are gone. Do not pour paint thinner on your skin. Apply liquid soap (without water) and rub and scrub. When the paint thinner appears to be gone, then use warm water on your hands. Put on some skin cream to protect your skin from chapping.

Dispose of the papers or cloths in a metal container with a lid outside the building.

GLUEING

Objectives

Members will be able to:

- recommend when to use glue
- list types of glue and their characteristics
- demonstrate glue application and clean-up
- demonstrate how to use glue and nails together
- explain the importance of removing excess glue before finishing
- store glue correctly

Activities

- view examples of use of glue in new and old woodwork
- view example of good gluing and bad gluing
- practice gluing and clamping
- Practice getting the correct amount of glue
- practice cleaning wet and dry glue off wood
- practice gluing and nailing
- practice clamping wood

Alternative Activities

- test and compare glue types
- compare the finish on wood that had a messy glue job to wood with a tidy glue job

The strongest joints use both nails and glue. The two most common glues used in woodworking are white glue and yellow glue (also called carpenter's glue).

White glue is an all-purpose glue that works for most woodworking projects. If you require an extra strong joint, choose yellow glue. Yellow glue is more expensive but provides a better bond.

Wood that has glue on it will not accept stain and finish the same way that clean wood will. Handle glue carefully.

To Use Glue

- Wood must be clean, dry and smooth or it will not glue successfully.
- Apply a wiggly line of glue to both pieces to be glued. Smear the glue around until all the surfaces are covered. If you use too much glue, it will squeeze out, make a mess and go to waste.
- Put the two glued pieces together and squeeze them. A small amount of glue should squeeze out on the edges. Line them up the way you want them. Clamp them, using wood scraps to prevent dents in the project. Clean up any excess glue.
- Lightly tighten the clamps at first. Check for positioning.
- Tighten the clamps further.
- Leave the clamps on for at least an hour.
- When you take the clamps off, leave the project overnight before you do any other work on it.
- Clean up.

How long for glue drying?

Check the label on your glue container. Most glue dries within 24 hours.

MULTIPLE CHOICE

Annual Rings

- The mark left in the tub after you take your spring bath
- A gift you give your spouse on your anniversary
- Lines that indicate the age of a tree
- A nice name for wrinkles.

Kerf

- A light slap on the side of the head
- A concrete edge on the side of the road
- A type of yogurt drink favored by Bedouins
- The gap or slot made by the cut of a saw or blade

Defect

- A type of filter for a camera. Put defect on the lens in bright weather.
- Small insect that bores into old wood.
- A type of varnish used in Europe.
- Flaw or weakness in something.

THINGS TO MAKE

Level One Projects.

1. Bench hook
2. Square Cut Box
3. Stilts
4. Name sign #1
5. Name sign #2
6. Folk Art Critter
7. Computer Shelf
8. Wooden Birds

Bench Hook

A bench hook steadies wood while you saw it. You hold the wood you are sawing firmly against the back of the bench hook. The front of the bench hook is hooked over the front edge of the work bench, so that nothing slides. Viewed from the end, a bench hook looks like a capital S.

Attach the lips so that the side edges are flush with the centre piece. If they aren't, any wood you hold with your bench hook won't be straight.

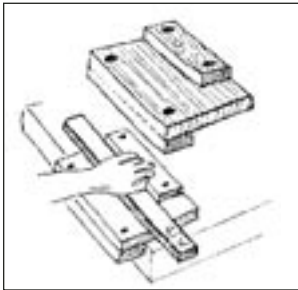

Materials

- 1 1x8", at least 12" (30 cm) long
- 1 1x2", at least 24" (60 cm) long

Tools

- 6d finishing nails
- wood screws
- wood glue
- sandpaper, 100 grit
- tape measure, try square, pencil, C-clamp, handsaw, hammer, screwdriver, protective eye wear

Cut List

- 1 1x8" base
- 2 1x2x8" strips (lips)

Instructions

1. Use the try square to see if your 1x8 is square. If it is not, mark a square line, then cut it. (Secure the board with the C-clamp because you don't have a bench hook yet!)
2. Use your tape measure to measure a point 8" from the new end of the board.
3. Use the try square and pencil to draw a line through that point, across the board. This is your other cut line.
4. Secure the board with the C-clamp. Cut on the cut line. This piece of wood is the base for your bench hook.
5. Square one end of the 1x2 using your marking tools, c-clamp and handsaw.
6. Cut two 8" pieces from the 1X2. These are called lips.
7. Glue and clamp the pieces together as shown in the diagram. Countersink the screws so they will not scratch any project.
8. Wipe off any extra glue that squeezed out.
9. Sand your bench hook with your sandpaper so it will not scratch your projects.
10. Take a picture of it! Initial and date your work. Note in your record book. Congratulations!

Square Cut Box

This box looks and works like a mitre box but is designed for square cuts only. It helps when cutting dowels or small bits of wood for projects. It would be nice to have one of your own, or to make one for a friend.

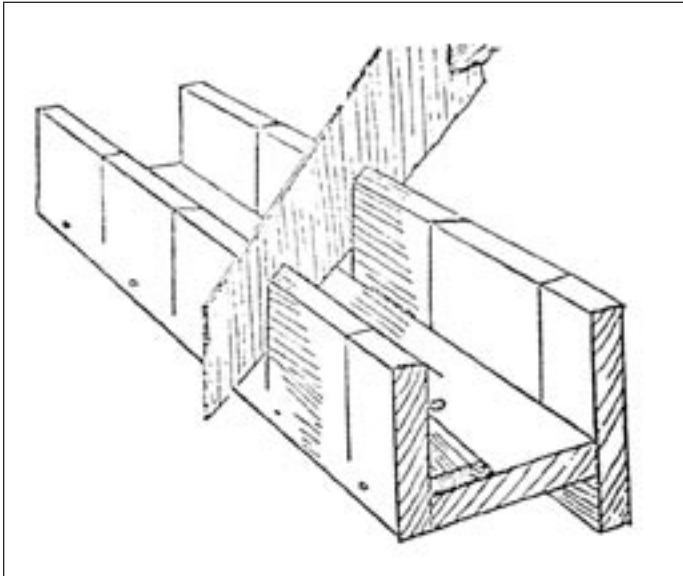

Materials

- 1 1x4, at least 40" (1 m) long
- 8 No. 10 x 1 2" flathead wood screws
- 4d finishing nails
- wood glue
- sandpaper, 100 grit
- duct tape

Tools

- marking tools
- c-clamp
- handsaw
- hammer
- protective eye wear
- twist drill and 5/32" bit
- screwdriver

Cut List

- 3 1x4x12"

Instructions

1. Check the end of the 1x4 to see if it is square. If not, use your marking tools to square it.
2. Clamp the board to the work surface. Use your marking tools to measure a square line across the board at 12" from the square end. This is your first cut line.
3. Use your handsaw to cut on this line. This piece will become the bottom of your mitre box.
4. Repeat steps two and three, to make the sides of your mitre box. Lay the unglued pieces against each other, as they will appear in the finished mitre box.

5. Have a helper hold the square cut box bottom on its long edge. Run a line of glue along the top edge.
6. Set one of the side pieces flat on the glued surface so that they look like a capital L from the end. The edges should meet evenly. Have the helper keep on holding them together.
7. Put on your protective eye wear.
8. Choose a spot about one inch from the end of the square cut box. Hammer a nail down through the side, into the edge of the bottom. Make sure the nail is straight up and down or it will break out of the wood.
9. Hammer a nail at the other end of the square cut box. These nails hold things together so you can later screw the pieces together more securely.
10. Turn the project over, so that the bottom pieces other edge faces up. Run glue along that upper edge.
11. Set the remaining side piece on the edge of the bottom piece (on that glued surface). Nail it as you did the other side. It should look like a C from the end.
12. Clamp the nailed square cut box to the work surface, so that the open side faces you. Mark the places for four screws on the side piece facing up. Space them evenly between the two nails.
13. Dimple the Xs by tapping a large nail with a hammer. Do not drive the nail in. This dimple helps the drill work more easily, without slipping.
14. Insert the drill bit into the hand drill.
15. Wrap a bit of duct tape around the bit at 1/2 from the sharp end. This marks how deeply you will drill.
16. Hold your hand drill straight up and down, so the holes will not come out of the boards. Drill a hole at each X. Stop drilling when you reach the duct tape.
17. Repeat steps 12 to 16 for the opposite side of your square cut box.
18. Drive the screws into the pilot holes you drilled. Keep pressing down on the screwdriver as you turn it. Keep working until the head is just even with the wood surface.
19. Set the square cut box on the work surface, on its bottom. The open side should be facing up.
20. Use your marking tools to mark six inches from either end on a top edge.
21. With a try square and pencil, draw a square line across both top edges. Turn your try square so you can mark a line on the face nearest you. Use the line you just drew to guide you.
22. This next cut is very important. Clamp the square cut box, open side up, to the work bench. Use a handsaw to carefully cut through both sides of the square cut box at the line drawn on the side. Cut until the teeth just meet the bottom. Do not cut into the bottom. This cut must be straight.
23. Sand. Take a picture! Initial and date your project. Note in your record book. Congratulations!

Stilts

These stilts have several settings so they can be adjusted for different sizes of users! Before you drill any holes, lay the pieces of wood together so you will understand the assembly. Measure twice, cut or drill once!



Materials

- 1 scrap 2 x 4, at least 16" long
- 2 scrap 2 x 2s, at least 60" long
- 1 scrap 1 x 2, at least 16" long
- 4 hex bolts, 3/8" x 7"
- 4 3/8" washers
- 4 3/8" wing nuts
- wood glue
- sandpaper, 100 grit

Tools

- square and pencil
- handsaw
- hammer
- protective eye wear
- brace with 3/8" bit

Cut List

- 2 2x4x6" (steps)
- 2 2x2x60" (legs)
- 2 1x2x6 3/4" (braces to keep feet slipping off steps)

Instructions

1. Measure and mark a square line at 60" on the 2x2 using your marking tools.
2. Clamp this piece to the work bench. Cut on the line. This will be one leg of your stilts.
3. Cut a matching stilt leg, the same length.

4. Clamp a stilt leg to the work bench with a piece of scrap wood under it. Using your tape measure, mark an X at every four inches, starting from one end, until you have marked four Xs. Mark the Xs in the centre of the leg.
5. Use the brace and bit to bore a hole at each X. The scrap wood under the leg protects the work surface when the bit cuts through the leg.
6. Repeat the marking and drilling steps for the other leg.
7. Clamp the 2x4 to the work bench with a C-clamp, with at least 8 inches hanging over the edge.
8. Measure, mark and square the 2x4 at six inches from the end. Clamp and cut it at the six inch line. This will be one step.
9. Repeat steps seven and eight to make a matching step.
10. Measure, mark and square a 1x2 piece so it is 6-3/4" long. Clamp and cut it. This piece will keep your foot from sliding off the step.
11. Repeat step 10 to make another brace. You will glue a brace to the outside edge of each step.
12. Put a step on the work bench on its edge. Put glue on the edge that is facing up.
13. Lay the flat face of a brace on top of the glued step edge, so that 3/4" of the brace hangs over one end. Put on your protective eye gear.
14. Hammer a finishing nail through the brace and into the step, at either end. Place the nails near the ends so that there will be room to bore holes for the bolts that hold everything together.
15. Repeat steps 13 and 14 for the other step and brace.
16. Mark where the bolts will go through this way. Place the step/brace piece on the workbench with the brace on the bottom. One edge of the step will face up. Measuring from the end of the step that is even with the brace, mark two marks on the steps edge, at 1" and at 5".
17. Square across the step's edge at each mark. Pencil an X at the centre of each line.
18. Clamp one step/brace piece to the work surface, with a piece of scrap wood underneath. Use a brace and 3/8" bit, drill a hole all the way through both X marks. Hold the brace and bit straight up and down so the hole does not come out the side.
19. Repeat step 18 for the other step/brace.
20. Sand all the pieces well, especially the legs where you will be holding on.
21. Assemble your stilts, making sure that the step/brace piece is right side up! Decide what set of holes to use. Push the bolts through the step/brace until they come out the other side of the leg. Put a washer and wing nut on each bolt and tighten.
22. Ask people to stand back while you practice or they might get bonked by a stilt! Take a picture!

Name or Message Sign # 1

Make this sign to hang on your door or sit on a shelf or mantel!

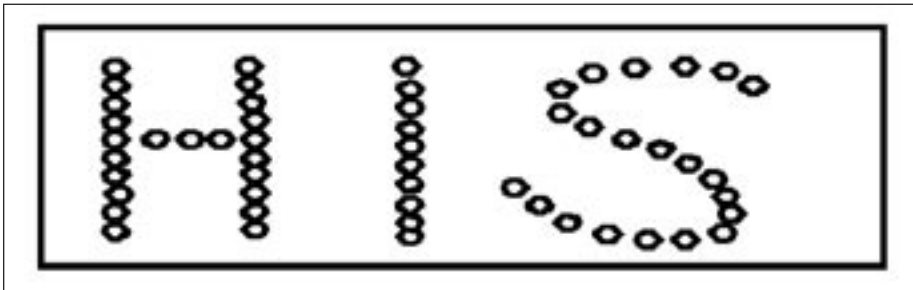

Materials

- Paper
- Scrap of 1 x 4, approximately 12" long
- paint or stain (optional)
- drill and bit

Instructions

1. Sketch the word or name for the sign on a piece of paper the same size as the finished sign will be. Practice two or three times until you are satisfied with how it looks.
2. Square off the ends of the 1x4 at a length that your word will fit on, plus one inch at each end. Sand it carefully.
3. Sketch your word/name onto the wood with a pencil.
4. Put a piece of duct tape at 1/4" on the bit of the drill. This will show you at what depth to stop drilling.
5. Drill holes on the pencil lines of the letters for the name/word.
6. Dust the sign. It might be necessary to vacuum the holes to get all the dust out!
7. You can leave your sign plain, or you can paint the surface with a roller, so that the holes show up against a painted surface.
8. Take a picture for your record book. Congratulations!

Name or Message Sign #2



Materials

- scrap of pine

Tools

- pencil
- ruler
- coping saw
- rasp
- sandpaper
- finish

Instructions

1. Write your name or message in rounded letters so that letters touch.
2. Cut out the name or message, being careful not to separate them.
3. Smooth with a rasp, if necessary.
4. Sand, then finish.

Suggestions for messages: Office, CEO, Joy, Peace, Hi!, Exit.

Folk Art Critter

Make this item to liven up a lawn or flower bed, or to adorn a shelf or mantel inside! Select your favourite critter or image as the subject. (E.g. a running horse or dog, a happy pig, a lightning bolt, a simple scene)

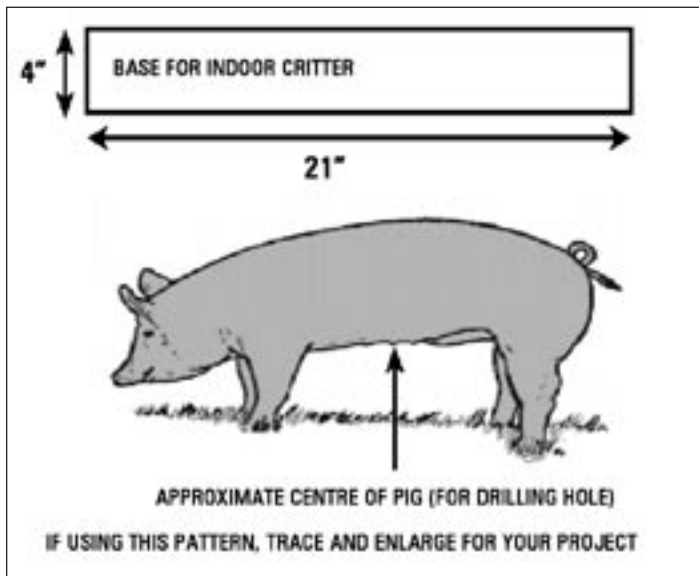

Materials

- 1 1 x 8 pine, 21" long (Body)
- 4 x 4, 21" long base (for indoor item)
- 2 to 3 feet of 1/4" dowel (for indoor item) or
- metal stair-runner rod (for outdoor item) for stand
- 14" square scrap of scrap sheet metal or thin wood for small detail pieces (e.g. legs, ears, tails etc.)
- Coping saw
- tin snips
- rasp
- sandpaper
- exterior grade paint (for outdoor projects) or
- acrylic paint (for indoor projects)
- artist's paintbrushes

Instructions

1. Trace or sketch your pattern for the main body part onto the 1 x 8.
2. Cut out using a coping saw. Use the rasp and sandpaper to smooth.
3. Trace or sketch the small detail parts (such as ears, tails, wings etc.) on the thin wood or metal. Cut using either coping saw or tin snips.
4. Assemble the critter without glue, as a trial. With adult help, determine where the centre of the critter is. Mark that spot on the bottom edge of the body with an X.
5. Paint all the pieces carefully. Let dry. Glue the detail pieces onto the main body with epoxy glue. Let dry.
6. For an indoor project, carefully drill a hole 2" deep at the X in the critter's body. Cut the dowel the length you want. Put a dab of glue on the end of the dowel and gently, but firmly push it into the hole.

7. For the indoor critter, drill a 1/2" hole in the centre of the base. Dab epoxy onto the bottom of the dowel and insert into the hole in the base.
8. For an outdoor critter, put a dab of epoxy on the end of the stair runner rod and push into the hole at the X.
9. Take a picture for your record book. Congratulations!

Computer Shelf

This is a small shelf that sits on top of your monitor so you can use that otherwise tilted space for something! Do you know anyone who might like one for a gift?

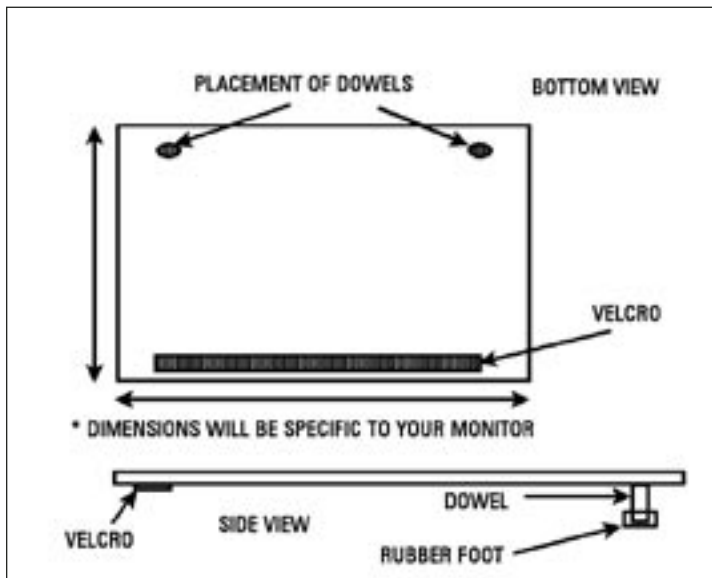

Materials

- wood the dimensions of the top of your monitor (3/8" to 2" plywood will do fine)
- dowel (1/2" to 5/8") the length will be determined by the angle of the top of your monitor
- two rubber or plastic feet to go on the end of the dowel
- glue

Tools

- saw
- measuring tools
- sandpaper
- drill
- adhesive-backed Velcro
- paint or stain

Instructions

1. Measure the width and depth of the top surface of your monitor to decide how big to make the shelf.
2. Cut the wood to these dimensions.
3. Set the wood on top of the monitor, so that the surface is flat. There will be a gap at the back of the board, between it and the top of the monitor. This is where you will put dowels as feet to hold up the shelf. Measure this gap.
4. With the wood still in place, mark the best place to install the dowels.
5. Cut the dowels to the length of the gap, plus the depth to which you will sink the dowels into the shelf. (Make the depth of the holes about 2 to 2/3 of the thickness of the wood.)
6. Drill two holes in the spots you marked.
7. Insert the dowels, with the rubber feet on, as a test. Place it on top of the monitor.

8. If you are satisfied with the dowel location and their length, glue in the dowels.
9. Sand lightly.
10. Finish with your preferred materials.
11. Clean and dry the top of the monitor where you will attach one side of the Velcro.
12. Attach a generous strip of Velcro to the top of the monitor. Attach the matching piece of Velcro to the appropriate spot on the computer shelf.
13. Take a picture for your record book! Congratulations!

Wooden Birds

This project will give you good practice in using a coping saw and sanding. You can paint the birds to make them look realistic or you can just stain or varnish the wood. You can hang these around the house or yard or even on the Christmas tree. Wooden birds sell well at craft fairs and make enjoyable gifts. You can also sketch other birds that you like and make them.

You could also make them in a bigger size and use them as lawn ornaments!

Materials

- Scrap pieces of pine or other soft wood (3/4" for the body and 1/2" or thinner for the wings)
- Sandpaper
- Finishing materials of your choice (paint, stain, varnish etc.)
- Cleaning supplies
- Small hook

Tools

- Pencil
- Tracing paper
- Coping saw
- Paint brush
- Hand drill and small bit

Instructions

1. Place your pattern pieces on the wood, with the arrow running in the same way as the wood grain.
2. Trace your pattern onto the wood.
3. Cut out the wood pieces.
4. Sand carefully.
5. Glue the wings to the bird. Remove an excess glue so it will not interfere with your painting. Let dry.
6. Paint or finish as you prefer.
7. Carefully insert the small hook into the top of the bird, so it will hang straight.

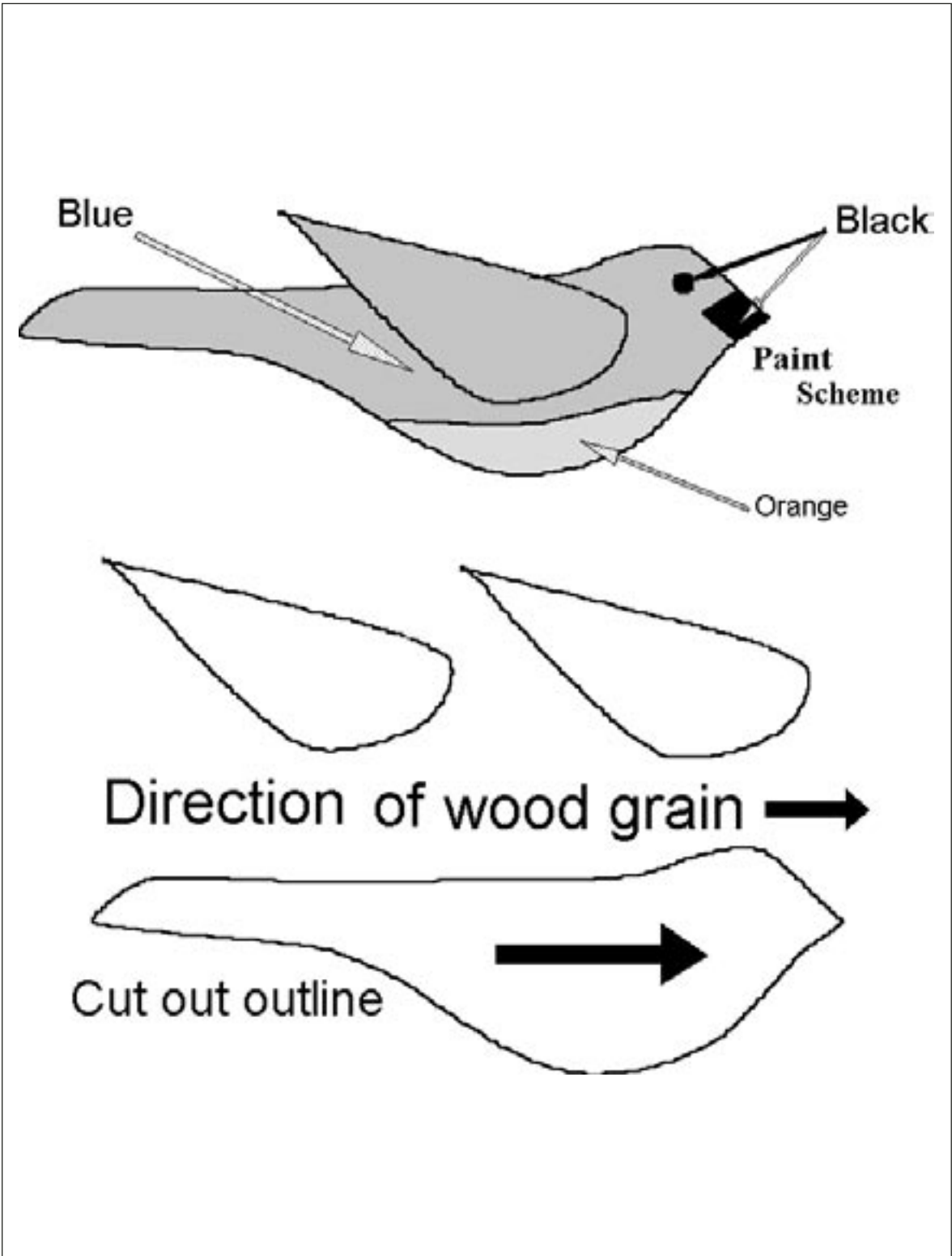

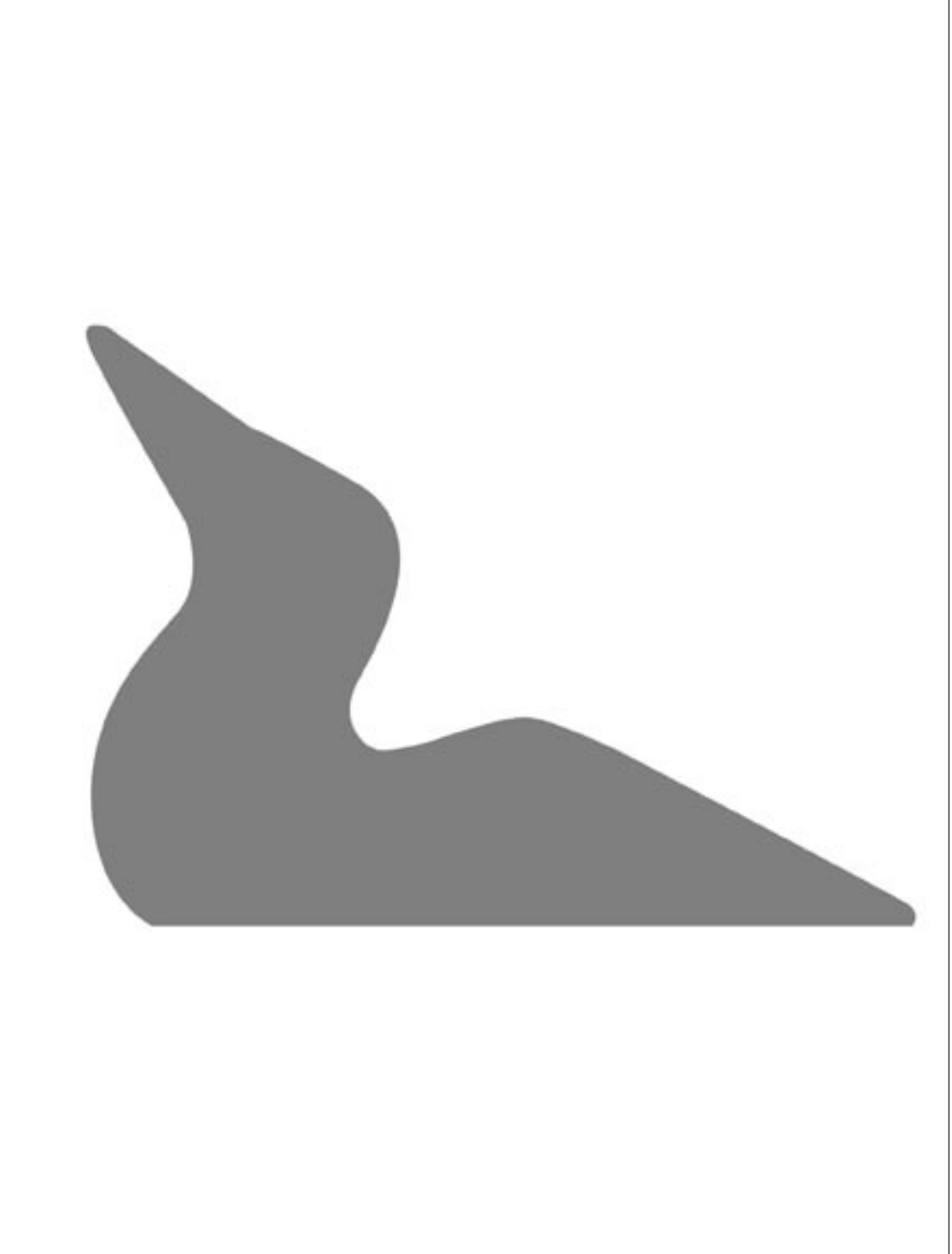

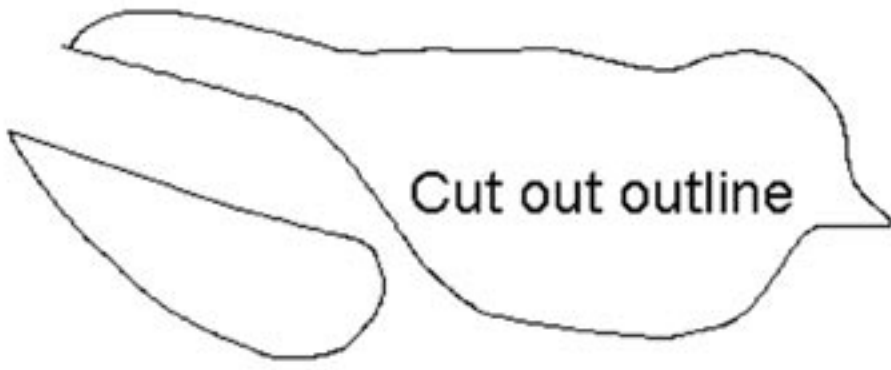
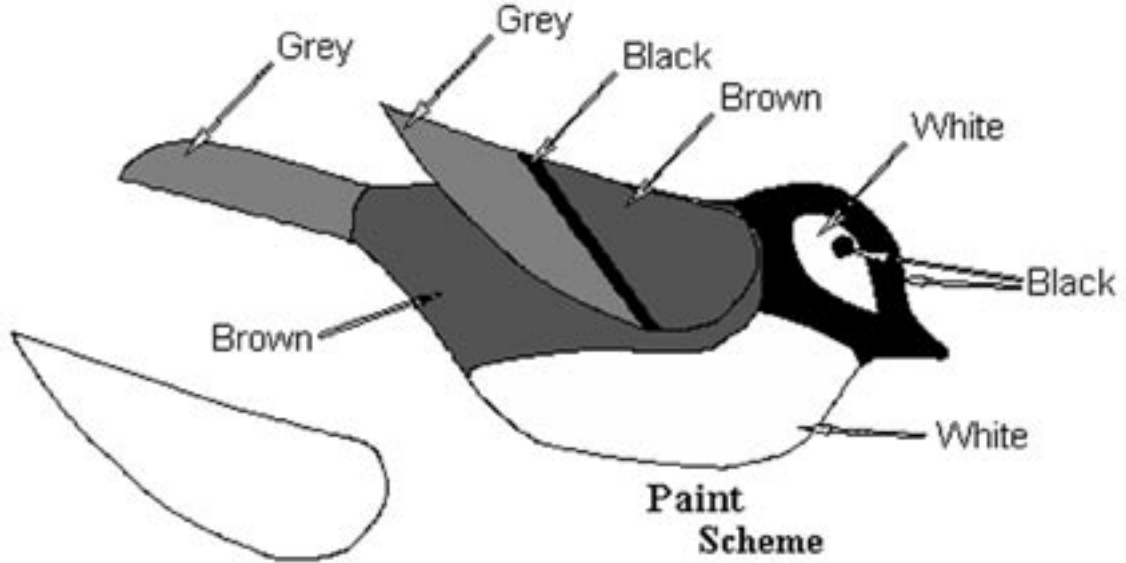

Direction of wood grain →

I CAN: LEADER'S SIGNATURES

Leader Signature

Safety

- Name common hazards in work area _____
- Explain how a person should dress when working with wood and tools _____
- Identify hazards in work area and respond appropriately _____
- Tell others about hazards _____
- Tell others about safe habits _____
- Inform adults about hazards _____
- Determine and take accident precaution steps _____
- Ask another member to stop if I see unsafe practices or hazards _____

Wood

- Name main parts of a tree _____
- Explain, in simple terms, how a tree grows _____
- Determine the age of a tree by counting rings _____
- Recognize at least two types of wood (e.g. Pine, oak) _____
- List characteristics of wood that make it a good building material _____
- List two characteristics of wood that make it a challenging building material _____
- Give a simple explanation of the role of the lumber industry in Canada's history _____
- Explain the difference between hardwood and softwood _____
- Explain steps to take to reduce warping in a project _____

Measurement

- Explain in simple terms, why measurement is important _____
- Explain difference between imperial and metric measurement _____
- Give examples of best use of: ruler, tape measure, square _____
- Accurately measure and cut wood _____
- Acknowledge the importance of using only one system of _____
- Measurement in a project _____

Tools and supplies

- Identify common woodworking tools and their proper use _____
- Identify common woodworking supplies and their proper use _____
- Recommend handling and storage to protect tools _____
- Safely use tools to build projects _____
- Use appropriate safety equipment _____

Gluing

- Explain why and when it is appropriate to use glue _____
- Name types of glues and their characteristics _____
- Explain and demonstrate application of glue _____
- Explain and demonstrate how to use glue and nails together in a project _____
- Explain clean up and storage of glue and applicators _____
- Give practical tips to avoid clamp scars on wood _____
- Explain the effect of glue on paint and varnish _____

Sanding

- Explain the purpose and value of sanding _____
- List the steps in sanding _____
- Identify the direction of grain in wood _____
- Explain the importance of sanding with the grain _____
- List steps to avoid problems with dust _____
- Demonstrate how to clean sandpaper _____
- Demonstrate how to sand tiny pieces of wood _____
- Identify the various grades of sandpaper and their use _____

Finishing

- Explain what is meant by finishing _____
- Explain the purpose and value of finishing _____
- List the steps in finishing _____
- Select an appropriate finish based on intended use, type of wood, personal taste _____
- Use finishing products safely _____
- Apply finishing techniques to selected projects _____
- Demonstrate proper cleaning and storage of materials and equipment _____

Patterns

- Explain the benefits of using a pattern _____
- Select pattern appropriate to skill level, resources available, personal interest _____
- Redraw a pattern _____
- Demonstrate how to read a pattern _____
- Trace a simple outline onto wood _____
- List sources for project patterns _____

My work as a gift

- Take pride in my developing skill in woodworking! _____
- Identify items I could make as gifts for individuals or the community _____
- Encourage other members to apply their skills for others enjoyment and benefit _____
- Look for opportunities to learn more about woodworking _____

LEVEL TWO: MEMBER'S MANUAL

Objectives

Members will be able to:

- Work safely with wood to produce personal projects made of wood.
- Identify and use woodworking tools and supplies in a safe manner.
- Challenge themselves with variety and varying levels of complexity of tasks in woodworking.
- Work cooperatively with others in a workshop environment.
- Develop skill in decision making, leadership, problem-solving, finances and communication.

Achievement Day Requirements

Level Two:

- Completed Record Book
- At least two projects which demonstrate the use of different finishing techniques and which required use of power tools.
- For one of the completed projects, the plans and a cardboard model of the project.
- Example showing the use of filler and wooden plugs. (If used in members project, additional examples are not necessary.)
- Example of a mitred corner, either in a project or as a model. (If used in members project, additional examples are not necessary.)

Additional Resources

People

- local woodworkers
- teachers
- family members
- other 4-H members or leaders

Places, Events and Organizations

- local woodworking clubs
- exhibitions and fairs that have a woodworking class
- colleges that offer woodworking, design, or similar courses
- displays
- museums sometimes have displays with wooden articles

Books

- ***Workshop Tips and Techniques***. Editors of Cy DeCrosse Incorporated, in cooperation with Black and Decker. Minnetonka, Minnesota: Cy DeCrosse Incorporated, 1991.
- Starr, Richard. ***Woodworking with Your Kids***. Newton, Connecticut: The Taunton Press, 1990.
- McGuire, Kevin. ***Woodworking for Kids***. New York, New York: Sterling Publishing Co., 1993.
- Lento, Robert. ***Practical Woodworking Techniques***. New York, New York: Sterling Publishing Co., 1999.
- Peters, Rick. ***Controlling Dust in the Workshop***. New York, New York: Sterling Publishing Co., 2000.

Magazines

- Woodworkers Journal
- Canadian Home Workshop
- Wood Magazine
- American Woodworker

Web sites

www.thewoodcrafter.net
www.leevalleytools.com
www.woodworkershop.com
www.intheworkshop.com
www.uniqueprojects.com
www.am-wood.com (Amateur Woodworker)
www.northpolechristmas.com
www.tdc.ca/ewebster.htm
www.feesa.ab.ca
www.woodlinks.com

SAFETY: LEVEL TWO

Objectives

Members will be able to:

- model safe shop practices
- recall and practise safe procedures
- explain and demonstrate safe procedures for use of tools and materials introduced in level two
- locate the First Aid kit
- find closest phone
- recall the emergency phone number

Prepare for the Meeting

- Review the safety contract. Complete your own.
- Assemble variety of personal protective devices (goggles, face shield, nuisance mask, respirator etc.)
- Inspect meeting area.
- Write directions to the meeting place from the closest town where emergency vehicles would travel from. Post these by the phone.
- Gather tools which can be inspected for their condition.
- Print “Who does an unsafe worker affect?” on flip chart. Draw a circle in the middle, with lines coming out from it.
- Plan a Hazard hunt, if you decide to have one.

Activities

- members identify hazard present in shop and preventative action (be sure to include horse play!)
- older members team up with younger members for hazard hunt
- inspect/evaluate safe condition of tools
- should damaged tools be repaired or replaced?
- demonstrate use, storage and maintenance of tools
- long-term hazard of dust particles
- fit safety equipment
- clean-up of work area

Alternative Activities

- photo of members wearing safety equipment for their record books
- have a tour as the first event of the year, with safety as a major component
- demonstration of use of a fire extinguisher
- make up a First Aid kit for the club to take on field trips

Safety in the Woodworking Project

List as many preventative actions as you can for the following risks:

AT RISK	RISK	PREVENTATIVE ACTION
EYES	Flying chips Dust Splashing finishes Splinters from breaking tools Fumes Compressed air used improperly	
EARS	Exposure to loud noises	
LUNGS	Exposure to very tiny dust particles (less than 10 microns) Exposure to fumes from finishes Inadequate ventilation	
SKIN, FINGERS, LIMBS, HANDS AND FEET	Punctures, rips from tools and rough wood. Crushing Pinching Exposure to chemical finishes Abrasions Burns from hot tools	
BACK	Lifting too much Falls from tripping over materials Turning incorrectly Lifting incorrectly	

You must purchase your own personal safety equipment for the 4-H woodworking project. Eye protection must be worn.



Who does an unsafe worker affect?

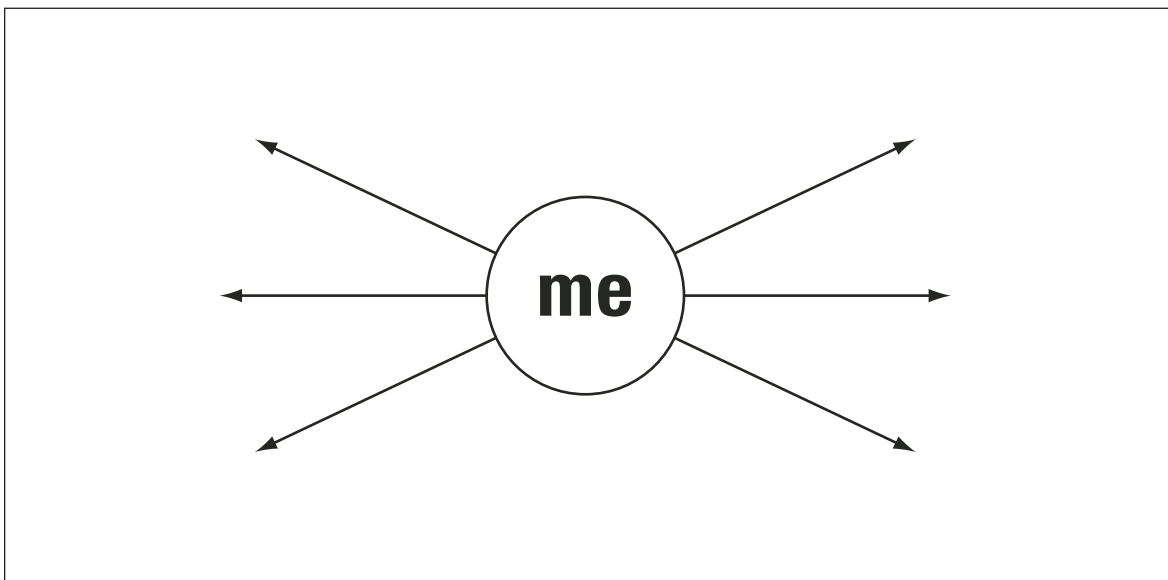

Safety Steps

1. Name the risks.
2. Safeguard the work area.
3. Wear necessary protective equipment.
4. Use the right tools.
5. Follow correct procedure.
6. Monitor work habits.
7. Correct as necessary.

Ensure all helpers follow safe procedures

- Where are the First Aid kits kept at your 4-H meetings?
 - Where are all the First Aid kits at home?
 - Who has First Aid training in your 4-H club?
 - Who has First Aid training in your family?
 - What phone number do you call for emergency help?
 - What are the directions to drive to your meeting place? (In case you ever had to give them to emergency people)
 - What are the directions to get to your home? (In case you ever had to call emergency people)
- Post these by all the phones in your home or shop.

Contents for a Basic First Aid Kit

A variety of bandages; antiseptic; tweezers; First Aid booklet; cotton swabs; sterile gauze; First Aid tape; needles (to get out slivers); eye drops.

SAFETY CONTRACT

I Will:

- identify risks of activities
- take actions to eliminate or reduce risk
- ask for help when needed
- select the correct tools, equipment and materials for activity
- watch for and allow for closeness to other people
- stop work and move back when ask to
- exit work area on command (in case of emergency)
- return tools and supplies to storage after use
- follow safe disposal procedure
- dress appropriately for club activities
- share responsibility for safety in the club

Member

Parent

Leader

Date

DRAWING FOR BUILDING

Objectives

Members will be able to:

- explain benefits of drawing before building something
- draw isometric and orthographic drawings of simple projects
- accurately find points on a drawing that match points on project
- transfer a pattern onto wood
- accurately enlarge a pattern

Prepare for the Meeting

- gather examples of drawings, patterns, sample paper or cardboard model made to scale from a pattern
- gather carbon paper, pencils, paper, rulers, erasers, cardboard, wood scraps, small boxes
- photocopied pattern, iron

Activities

- make orthographic and isometric drawings of small boxes
- members swap drawings and build a paper or cardboard model of the small box from the drawing (at half scale, if the box is relatively large)
- members use a grid pattern to enlarge a pattern
- members transfer a pattern onto wood using carbon paper, pencil
- members transfer a pattern onto wood using a photocopied picture and a hot iron

Benefits of Drawing a Project before Building it

- helps you better understand how the project will fit together
- helps you think through the stages of the project and anticipate what you will be doing and what you will need
- a good drawing makes for a good project

Benefits of building a paper or cardboard model of a project

- allows you a dry run at the project
- helps you understand how things fit together
- you can test and adjust size, if necessary
- it helps keep you on track and prevents mistakes
- it can encourage you!
- you can try out different stains on paper instead of wood

Isometric Drawings

- Shows what an object would look like from one side and a bit below your eyes (like looking down at something sitting on a table)
- Is helpful for getting an idea of what the project will look like
- Helps indicate what type of materials will be needed

Sketch an example of an isometric drawing here.



Orthographic Drawing

- This type of drawing splits the object into different views: the top, the sides and the front
- An orthographic drawing is drawn accurately and to scale*

** to scale means that each measurement on paper is in proportion to a measurement in real life. e.g. One cm on paper represents 10 cm in real life.*

Sketch an example of an orthographic drawing here.

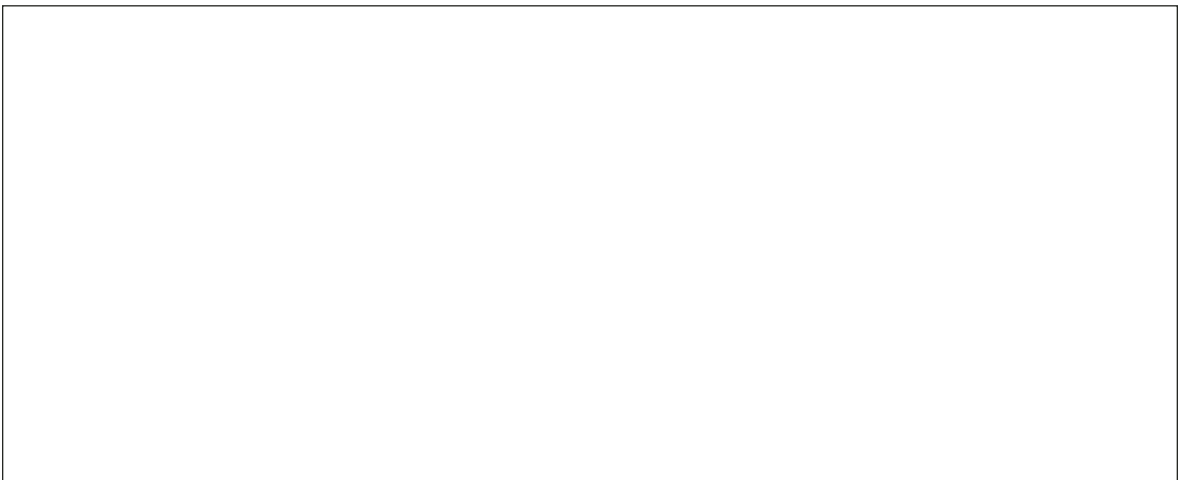

Practice

Materials

Small box or rectangular object, ruler or tape measure, unlined paper, pencil, eraser

Procedure

1. Draw an isometric drawing of a box here.

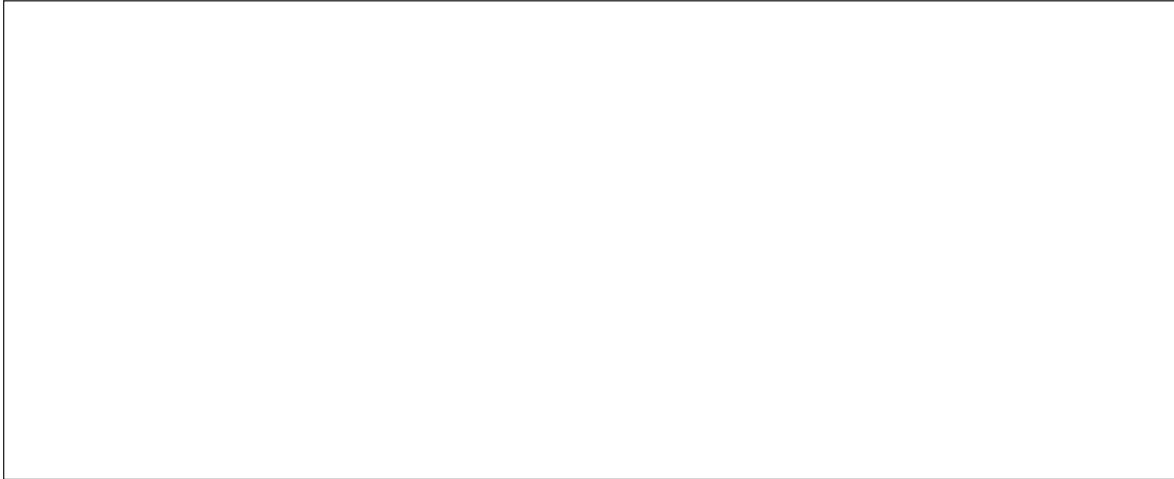

2. Measure the box. Draw the box in isometric style. Do a neat job, using your ruler for the lines. Print on all the measurements of all sides on. Put the box away.
3. Use your isometric drawing as a guide. Now draw an orthographic drawing. Make the scale 1 to 2 (one cm on paper means two cm on the actual box). This is written as 1:2.
4. Show the three views: top, side and front. Label neatly with all the measurements. The drawing should be exactly half the size of the box. Print 1:2 at the bottom right corner.
5. To test the accuracy of your drawing, swap orthographic drawings with another member and build a paper or cardboard box from each others drawings! Measure and cut accurately to the drawing. How do your boxes turn out?

Enlarging a Pattern

Use a photocopier with an enlarging feature. Or, since not everyone has a photocopier in the back room, use a grid system to enlarge a pattern to the size you want!

Using a Grid to Enlarge a Pattern

Draw a grid on the original pattern or on a copy of it. Number each line and letter as shown.

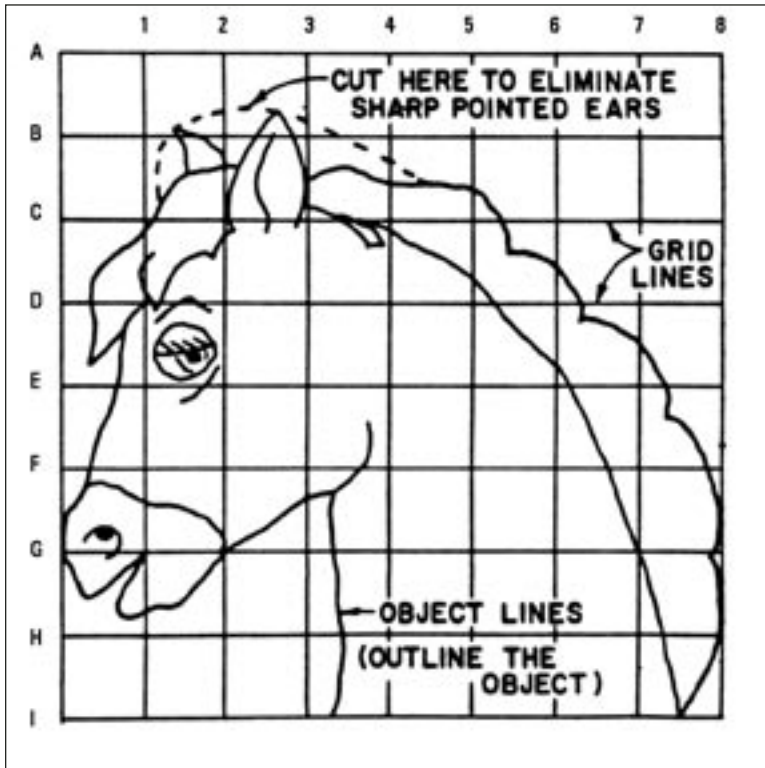

Decide the size you want the project to be. Draw a grid with larger squares to fill the space that you want the project to be. Use the same number of lines that you used on the original pattern.

See where the grid lines cross the objects lines in the first drawing? Place dots on the same points and lines on the larger pattern. When you have all the dots on the new pattern, connect the dots, using curved and straight lines like the original. The new pattern will be a larger version of the original drawing.

You will display this enlarged copy at Achievement Day!

Copying a Pattern onto the wood of a project

Use carbon paper and a dull pencil to trace a pattern onto wood. Secure the pattern with masking tape to ensure a clean copy.



Transferring with a Photocopy and an Iron

Photocopy the pattern you want. Tape the pattern onto the wood. Press with a hot iron to transfer the pattern. Check a few times to ensure the pattern is transferring completely.

If the pattern has words on it, you will have to reverse it (or the words will print backwards.) Make your first copy on tissue paper. Then turn that tissue paper over, and make a copy of it. The lines should show through the tissue well enough to copy backwards onto regular paper. Then iron the second photocopy on your wood.

TOOLS

Objectives

Members will be able to:

- identify, explain and demonstrate the safe use of chisels, power drill, power sanders, jigsaw, hand drill and the brace and bit

Prepare for the Meeting

- Gather a variety of the tools. If possible, gather damaged tools too.
- Provide a selection of wood scraps to be practised on!
- Arrange for extra adult help.

Activities

- practice, with supervision, with the tools which have been demonstrated
- members inspect work done by these tools e.g. chisel
- give recognition for straightest hole drilled; safest shop behaviour; best hole drilled without splinters; tidiest work area; biggest wood chip from brace and bit etc.
- encourage members to note when another member demonstrates safe shop behaviour

Alternatives or at-home activities

- field trip to woodworking shop or supply
- virtual field trip on-line to supply house. Compare a variety of tools
- at historical site, inspect tools used by pioneers, as well as the work they accomplished.
- members complete a tool inventory

Chisels

Chisels are sharp wood knives which are used to remove unwanted strips of wood. The end of the blade is the sharp part which cuts with a pushing action. The tip of the blade is slanted or beveled. Most chisel work is done with the bevel side down against the wood. Whenever possible, use your chisel with the grain of the wood.

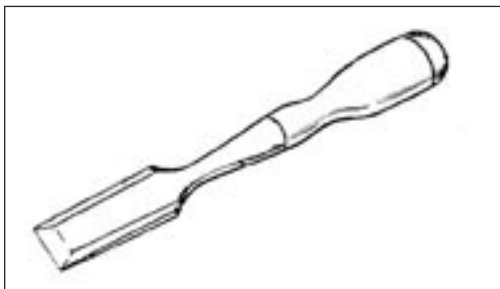

Characteristics

- very sharp
- available in a range of qualities and sizes
- need to be kept sharp so they do their best work

Safety

- chisels can easily slip and cut flesh
- keep both hands behind the chisel
- secure the wood project with a clamp or vise

Care and Storage of Chisels

- protect the blades by putting an old tennis ball or chunk of styrofoam over the end
- keep from moisture
- place them, do not throw them into the drawer
- put a piece of old carpet in the bottom of the drawer or tool box

How to Tell When to Sharpen Chisels?

- they start getting harder and harder to push (overall dullness)
- they start cutting irregularly (chips in the edge)

Power Drills

Power drills speed up the job of drilling holes. They can also speed up errors or injuries, so need to be handled carefully. Most drills will also work in reverse, which is very helpful if you have to remove screws with a special bit.

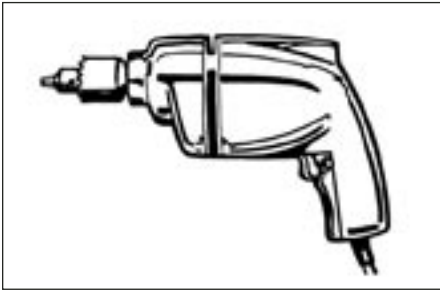

When you drill with any drill, make sure you drill straight, without putting bending pressure on the bit. Otherwise, you could spoil the bit and probably the hole you are drilling. Ask someone to watch you as you practice.



Power drills come in two formats - plug in or rechargeable. A plug in drill is stronger and works as long as there is power (makes sense!). Rechargeable drills are convenient where power is not available or for working in very tight or awkward situations. Rechargeable drills are much heavier and larger because they include a battery. They are not as powerful as plug in drills but are capable of doing the work for most 4-H projects.

When the battery runs out, replace it with a recharged battery. Follow the recharging instructions that came with the drill.

Safety Notes:

- never use an electrical tool or appliance in damp conditions
- ensure the cord is in good condition
- ensure the key is removed from the chuck before using the drill
- have a firm grip on the drill when using
- keep the bit away from skin
- secure the object being drilled so it will not spin
- ensure that the drill bit has quit spinning before setting it down
- keep long hair and loose clothing away from the drill
- drill bits get hot from friction and can burn
- ensure the drill bit is securely inserted before starting the drill

Brands we looked at:

Characteristics

Safety Observations

Advantages of Using a Power Drill

Disadvantages of Using a Power Drill

Care and Storage of Power Drills

- gather the cord up and snug it up with the drill
- take the bit out and put it in its case or protect the bit with a chunk of styrofoam
- protect from moisture or excess dust

How to make sure I drill straight with a power drill.

Which of your projects will require the use of a power drill?

A drill can also be used to put in screws. Practice this on some waste wood.

Tip: When you need to control the depth of a hole you are drilling, stick a bit of tape on the drill bit at that depth. When you reach that depth while drilling, stop. You will be at the correct depth!



Practice using a Drill

Materials

Clamp, scrap wood, various sizes of drill bits, plug-in or rechargeable drill (or both!)

Procedure

1. Clamp the piece of wood securely. Ensure all safety steps are observed.
2. Leader demonstrates putting a drill bit in the drill. After observing, try this yourself. Have the leader check to ensure the bit is secure.
3. Practice drilling various sizes of holes.
4. Practice using both plug-in and rechargeable drills, if both are available.
5. Concentrate on drilling holes that are straight up and down.

Jigsaw

The jigsaw is an electrical tool with a small blade that moves up and down. It is used to cut both straight and curved lines. Using a jigsaw is similar to holding an iron. The teeth point upwards so the blade cuts on the upward stroke. Most jigsaws have more than one speed. The saw does its best work when set at full speed.

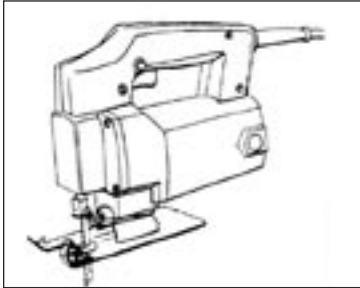

Safety

- Wear goggles to prevent injury from flying chips.
- Hold the jigsaw until the blade has completely stopped. Otherwise it will move about, injuring someone or causing other damage. Also, it looks stupid.
- Make sure whatever you are cutting with a jigsaw is secure.

Tips for Using a Jigsaw.

- sometimes you have to make separate cuts to complete cutting into a tight spot
- do not force the blade to turn too quickly or you will bend or break the blade
- start the blade going before it touches the wood

Models of Jigsaws we tried

The Jigsaw I Preferred and Why

Power Sanders

Most woodworking shops have two kinds of power sanders - the belt sander and the vibrating sander. They are used for larger sanding jobs and can use a variety of grits of sandpapers. Power sanders can do the job faster. They can also make mistakes faster and deeper than hand sanding!

Belt Sander

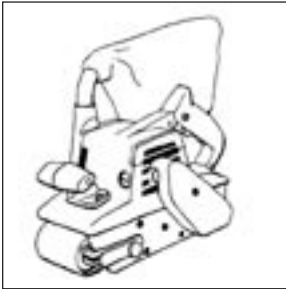

The belt sander has a loop of sandpaper which is fitted and snugged over two wheels attached to a motor. Belt sanders are quite powerful, noisy and can cause injury. Your leader will demonstrate belt sanders. As with all tools, make sure the sander has finished working before you set it down.

Vibrating sanders work by shaking or vibrating a piece of sandpaper attached to a plate which is attached to its motor. Use a vibrating sander to smooth wood surfaces and take out scratches. Most use a quarter of a sheet of sandpaper. Vibrating sanders are considered to be safer than belt sanders.

When using a vibrating sander, do not lean on it. That would wear out the bearings and also probably do a terrible job of sanding. Move the sander over the project with the grain of the wood with just the weight of the sander and your hand on it. Make sure it has stopped moving before you set it down.



Tips for Using a Sander

- Turn on the sander before touching the wood.
- Land it gently on the wood.
- Sand with the grain.
- Overlap your work a bit each time.
- Wear dust protection. Work outside when possible.
- Lift the sander off the wood, then turn it off.
- Make sure the sander has stopped completely before setting it down.
- Your sanding is only as good as your sandpaper. If your paper is worn out, replace it!

Safety

- work only in dry conditions with electrical tools
- use grounded cords in good condition
- keep the sandpaper surface away from skin

Brands of Power Sanders we looked at:*Characteristics*

Advantages of Using Power Sanders

Disadvantages of Using Power Sanders

Care and Storage of Power Sanders

How to Change the Sandpaper

Each power sander has slightly different ways to change the sandpaper. Ask for a demonstration or read the manual for the power sander you are going to use.

Hand Drill

This is a great tool that looks like an eggbeater! It has a clamp at one end called a chuck that will hold different sizes of smaller drill bits. It is powered by turning the crank.



To Chuck (install) a Drill Bit

Hold the drill in one hand. Twist the chuck until it opens up. If the chuck seems to be stuck, hold the chuck while you turn the crank a bit. Slide the flat end of the bit all the way up into the chuck, then tighten the chuck against the bit.

To Drill a Hole

Dimple the spot where you want to drill a hole by tapping a nail there with a hammer. This makes a small hole so your drill will not move. Set the bit in the dimple. Hold the drill handle with one hand, pressing down on it as you turn the crank. Hold the hand drill straight up and down so the hole will be straight.

To remove the drill from the hole, turn the crank the opposite direction.

To Drill a Hole a Certain Depth

Measure the depth on the bit, then stick some duct tape at that spot. Stop drilling when you reach that piece of tape.

Drilling Pilot Holes for Screws

Screws go into wood much more easily if you drill a pilot hole. Choose a bit that will remove most of the wood, while leaving enough for the screw to grip on.

Practice

Materials

Hand drill, bits, scrap wood, screws, screwdriver

Procedure

1. Screw a screw into the wood without a pilot hole.
2. Choosing a bit that is smaller than the screws you are using, drill a pilot hole.
3. Screw the screw into the pilot hole. Compare the effort needed for both jobs.
4. Practice drilling holes straight up and down.

Brace and Bit

We use this tool to drill larger holes. It looks like something from a dental nightmare! The brace and bit is a very old design that has stood the test of time. It was used to make the ships that brought many of our ancestors to Canada and many of the historic buildings in our country. Watch for used ones at auctions. They are valuable additions to your tool box.

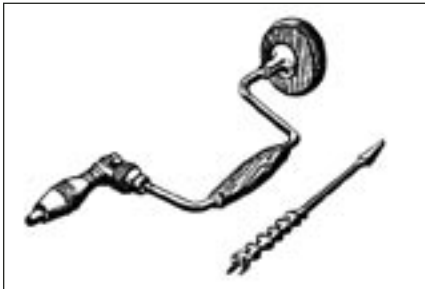

The brace is the curved metal which has a small knob handle at the end and another longer handle on the bumped out middle section. At the working end there is a chuck which holds the bits.

The bits have three parts - a square or rounded end that fits into the chuck; a spiral shaft, and a screw-tipped end. Bits come in many sizes.

Using a Brace and Bit

Because of its spiral design, the bit actually pulls itself into the wood as you crank the brace! The sharp tip on the bit does its own dimpling of the wood.

Hold your brace and bit straight up and down when drilling so the hole will be straight.

Put a piece of scrap wood under your project so you do not make a series of holes in the work bench.

To remove the bit when the hole is complete, pull it up and out.

Tip: Some braces have a switch or collar that you have to adjust to tighten the chuck, for removing the bit from the hole.

Sometimes it helps to put your project down on the floor and kneel on it while you are using the brace and bit. It is quite a big tool and it helps to be above it when using it.

USING SCREWS AS FASTENERS

Objectives

Members will be able to:

- tell when to use screws instead of nails in a project
- name parts of a screw
- list advantages/disadvantages of types of screws
- drive a screw into wood without splitting the wood
- explain sizing of screws
- select correct size of screws for projects
- select correct size and type of screwdriver for screws
- explain/demonstrate how to avoid stripping screws or damaging the head
- demonstrate how to cover up screws in a project
- Prepare for Meeting
- find or make simple joints, one made with nails, one with screws
- gather a variety of types and sizes of screws and screwdrivers
- gather scrap wood for practice
- gather examples of wooden plugs
- draw a simple drawing of a screw on flip chart paper
- draw the heads of slot, Phillips and Robertson screws

Activities

- compare the strength of a nailed joint to a screwed joint
- draw and label a simple drawing of a screw
- practice driving screws with and without pilot holes
- practice using wood filler and wooden plugs to cover screws

Alternates

- inspect various items in the meeting area or around home to see what kinds of screws are used for different purposes

Screws have three parts- the head, the shank and spiral threads ending in a sharp point. The spiral threads pulls the screws into the wood as you turn the screwdriver. Screws hold pieces of wood together by gripping the wood with the threads. Never hammer screws into wood.

Different Screw Heads

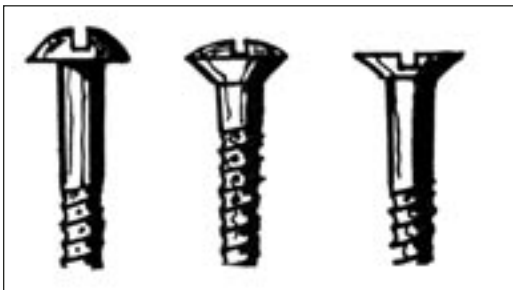

Screws come in many shapes and sizes. The most common size of screw is the #8. Thickness ranges from #4 to #12.

The most common styles of screwdrivers are the slot, the Phillips and the Robertson.

The slot screw features a simple groove cut across its head. Screwdrivers can easily slip from this groove and damage the wood.

The Phillips or star head is used more often in cars and metal work than in woodwork.

The Robertson or square socket is favoured for woodworking in Canada. The right sized screwdriver tip fits snugly in its square head.

Use of Pilot Holes

Drill a small pilot hole that is smaller than the screw you will be using. This will prevent the wood splitting. It will also make driving the screw an easier job.

Using a Power Drill to Drive Screws

You can drive screws with a power drill with a special attachment. Make sure you use the right size of screwdriver tip or you will ruin the head of the screw.

When the screw is as far as it will go into the wood, STOP! Otherwise you will ruin the head.

Camouflaging Screw Holes in Projects

Use putty to cover up screws. Let it dry. Sand.

Use wooden plugs that have been finished the same way as the project. If there is a grain showing in the plug, make sure the grain runs the same way as the grain in the project.

MEASUREMENT TOOLS

Objectives

Members will be able to:

- identify and demonstrate use of try square, steel utility or framing square, steel/combination square, pencil compass, scratch awl

Prepare for the Meeting

- gather several of the tools, for members to practice with (make sure they are all identified with the owners' names!)
- gather wood, pencils

Activities

- members practice using the various tools for their many purposes
- members use scratch awl and combination square to make a line a uniform distance from the side of a board

Alternative Activities

- visit a renovation or construction project
- virtual field trip to woodworking supply house
- field trip to a hardware store which supplies woodworking tools

Marking Gauge

Use a marking gauge to mark a uniform width on a board, for cutting or for marking where to drive screws.



Set the pin at the desired distance from the face of the head and check it with a ruler. Sometimes the pin can get bent and this alters the accuracy of the scale on the gauge. When you have the correct measurement, tighten the pin.

Push the gauge forward when marking. Turn the gauge slightly so that both the beam and the pin touch the wood at the same time. This lets you see what the pin is doing. Make sure you keep the face of the gauge against the wood edge, so your mark is accurate.



Look at the picture. Give advice to this woodworker to correct her use of the marking gauge.

T – Bevel

This is a very useful tool and also a very old design. Use a T bevel to lay out mitres or to test mitred corners or beveled or chamfered edges. Another valuable use is duplicating an existing angle. Loosen the screw to free the blade. Find the angle you are checking, then tighten the screw.



Try Square

Use a try square to test for right angles in lumber or to test for squareness in projects.

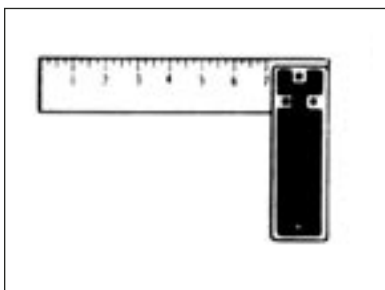

Steel Utility Square or Framing Square

Builders use this square to construct buildings. Its greater length makes it more accurate.

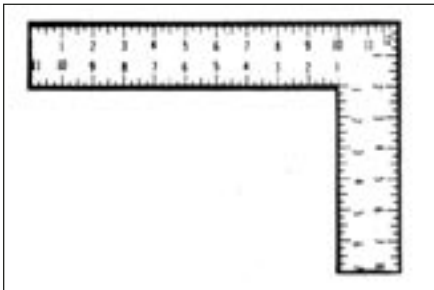

Steel Combination Square

A combination square can measure for both 45 and 90 degree angles. It can be used to measure for mitre joints. This tool is also adjustable. It is a very handy tool to have in the tool box.

You can use the combination square to mark a line a uniform distance from the edge of a board. Decide how deeply you wish to mark the board and set the blade to that depth. Hold the square securely against the edge of the board. Hold an awl at the end of the blade which is at the correct depth. Mark the wood with the awl as you slide the square along the edge.

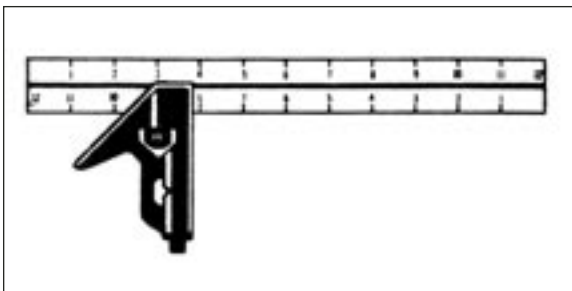

Pencil Compass

Use the compass to draw circles for projects. Set the compass so that the pencil tip and needle point meet when the compass is closed. Always have a piece of cardboard or scrap wood under the compass point so you do not scratch surfaces underneath.

Scratch Awl

Use a scratch to mark wood precisely for cutting. An awl is extremely sharp and strong. Handle with extreme caution and store carefully.

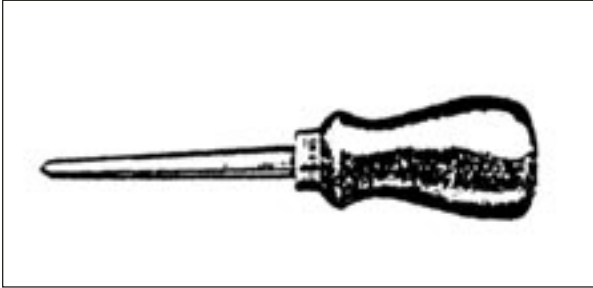

Care of Tools

- Store tools where they will not be dropped or bumped by other tools or materials.
- Use tools only for what they were designed.
- Use the correct size of tool for the job.
- Never force a tool.
- Secure tools so they will not drop off work surfaces or hangers.
- Keep them as clean as you can.
- Some people make or buy fabric socks for some of their more delicate tools, such as planes. This protects them from damage and dirt.
- It also keeps them out of sight from potential thieves. Tools are also prime targets for thieves.
- For pointed tools, protect the point (and your fingers) by storing the point in an old tennis ball or wrap in a piece of dry canvas or leather.
- Label tools with your name and phone number, if possible. This will prevent mix-ups at meetings.

GLUING

Objectives

Members will be able to:

- explain how glue works
- select the correct glue for the job at hand
- demonstrate correct gluing and clamping technique
- suggest a variety of ways to clamp
- explain how glue can affect finishing
- demonstrate safe and economic use, clean-up and storage of glue

Prepare for the Meeting

- gather examples of glued items (examples of good and bad gluing)
- gather examples of different brands of glue
- gather samples of dirty wood, greasy wood, painted or varnished wood, clean rough wood, clean sanded wood
- if possible, provide an example of glue that has been frozen
- gather a variety of clamps and materials that can be used as clamping devices (pieces of inner tube, styrofoam, elastic tubing etc.)

Activities

- members compare examples of glued items
- members practice gluing and clamping wood scraps
- members practice gluing dirty and clean wood and evaluate strength of bonds produced

Glue is usually used with nails or screws. This is a very strong combination. Glue works by being absorbed by both wood surfaces. It actually enters into the layers of wood and forms a bond with it. When we hold the two wooden surfaces together as the glue dries, they become bonded.

The two most common glues used by woodworkers are white glue and yellow glue (carpenter's glue).

Prepare Wood for Glue

Glue works best when the surfaces are clean, dry and free of dust. It is important that the wood pieces fit together well, with no gaps. Hold them together without glue to be sure that they fit well.

It is important to hold the pieces together while the glue is setting, so that the bond can form. Be careful not to press them together so tightly that the glue squeezes out.

Tip: To spread glue more evenly over a large surface, make a glue spreader out of an old credit card (or similar hard plastic card). Trim the long edge of the card with pinking sheers to help with the spreading.

Clamping

Choose a means of clamping the pieces of wood that will keep them snugly without damaging the wood. Woodworkers use clamps, pieces of inner tube, rope, clothes pins and other contraptions to secure the wood while the glue dries. Allow the project to dry well before proceeding to the next step of construction.

The combination of glue on a metal clamp can make a stain on wood. Cover metal clamps with masking tape where glue might touch them.

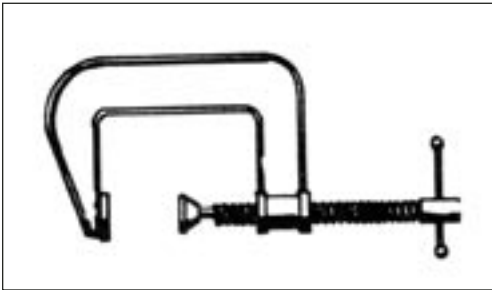

Tip: You can use a drinking straw to pick up excess wet glue at a joint. Push the end of the straw against the seam until it conforms to the shape of it. Then push it along the wet glue, to pick it up.

Clean Up

Use a warm, damp, clean rag to wipe up wet dribbles. Glue dries clear but will interfere with finishes. (Stains will not absorb into the wood at a glue spot.)

Storage of Glue

Store glue where it will not freeze or be in direct sunlight. Ensure the container is sealed to prevent the entry of air. If the original cap is weak or faulty, try a mariette, the screw type cap used to connect electrical wires. The screws in the mariette will dig into the plastic of the spout and block air entry.

Some woodworkers like to store their small bottles of glue upside down so that the glue is ready to go. (These are woodworkers who are sure that their glue lids are secure!). You can store glue bottles upside down in a coffee can or even build a wooden holder that looks like a giant toothbrush holder.

Tip: You can put a large headed nail into the tip of a glue bottle, then put on the cap. Pull the nail out to clear the tip out before you use it next time.

Practice

Materials

Types of glues, scraps of clean wood, painted wood and dirty wood, a variety of materials to use as clamps.

Procedure

1. Glue two dirty or greasy pieces of wood together. Clamp and let dry.
2. Glue two clean pieces of wood together. Clamp and let dry.
3. Glue two pieces of painted wood together. Clamp and let dry.
4. Compare the strength of the examples at the next meeting. Your conclusions? How will these joints stand up over time?
5. Practice gluing pieces of wood together and determining how much glue is enough. Practice cleaning off excess glue with a warm, damp, clean cloth. Maybe later you can practice staining this piece and see how the glue affects the staining process.
6. Compare the types of glues that you have. What differences do you notice in how the glue flows, sticks, smooths, and bonds?

Observe

Look around home, school and public places to see places where glue has been used.

Sometimes you will see fine examples of gluing. Other times it will look like a glue fight happened. Learning how to glue effectively and neatly is an important skill to develop.

Sometimes you will see very old examples of gluing that still work. Other times you will see where the glue has failed. Often woodwork has to be taken apart, scraped well, reglued and clamped. For example, kitchen chairs that get a lot of use often need regular regluing. (Whether they get it is another item.)

SANDING

Objectives

Members will be able to:

- identify and explain use of orbital, belt and vibrating sander
- list advantages/disadvantages of each
- select correct sander for job and operator
- list and demonstrate dust management techniques
- explain the significance of dust management as a health issue

Prepare for the Meeting

- gather various models of the types of power sanders
- review safety contract
- find examples of sanding errors
- gather samples of various grits of sandpaper used on the models of sanders
- gather examples of dust protection equipment
- gather wood scraps for practice
- gather examples of projects in various stages of sanding

Activities

- members compare various models
- members practise using power sander (depending on member size, strength, maturity etc.)
- members compare jobs done by power sander to hand sanding results
- members practice cleaning sandpaper used by power sanders
- members compare personal dust protection equipment
- members inspect shop dust management equipment and procedures
- members clean up the shop!

You will collect a variety of grits of sandpaper as you work on more and more projects. Keep your sandpaper in a dry place, sorted by grit.

Hand sanding is the ultimate and most precise sanding that wood can receive. But we often use sanding machines to do some of the work. Choose the correct machine to do the job.

Sanding machines can be heavy and require a certain amount of strength and stamina. If you find yourself getting tired, stop.

Using a Power Sander

Turn on the sander before touching the wood. Land it gently on the wood.

Hold the sander firmly. Do not press down. The weight of the machine itself and the guidance of your hands are all that is usually required. Sand with the grain. Overlap slightly, parallel to the grain. When finished, lift the machine off the wood, then switch it off. Make sure it has stopped before you set it down.

Sand lightly. You can always sand again. You cannot replace a layer of wood that you hastily removed.



Belt sanders

Operate with a circle of sandpaper powered by a small motor. The sandpaper comes in a range of grits. These can be quite heavy.

Orbital Sanders

Move in a circle, up to 20,000 spins in a minute! That could also mean 20,000 scratches a minute!

Keeping dust to a minimum

It is best to trap dust at the source. Many sanders have a dust attachment. Keep this on and empty it regularly.

- Wear a proper respirator.
- If weather permits, do your sanding outside.
- This woodworker is sanding outside. She could still benefit from wearing dust protection.
- Sweep often.
- Vacuum dust up regularly with the shop vacuum.
- If your work area has a dust management system, clean out the filters regularly.



Practice Using Various Types of Sanders

Materials

Scraps of woods (different roughness and hardness); a variety of sanders; eye protection; dust protection

Procedure

1. Clamp the wood to be sanded.
2. Practice using various sanders and grits of sandpaper on the wood. Compare the quality of the work done. Your thoughts?
3. Which type of sander did you prefer? Which model? How heavy was the sander? Is a power sander right for you right now or do you prefer hand sanding?

Tip: After you have just sanded a surface, dampen it lightly. This will raise any imperfections and you can sand again, producing a smoother finish!

Tip: To sand into a corner, put a bit of sandpaper on the tip of a putty knife and use that.

Tip: To sand very small parts with a sander, attach the small part to a larger piece of wood with double sided carpet tape.

Tip: Use an emery board to get into those tiny spots that need sanding.

Using Filler

Filler has a strong odor. Use in a well ventilated area!

A filler can make your project even smoother! Filler comes as a paste and is made from ground silicon, linseed oil, color, a drying agent and turpentine. It is available in natural wood color or can be matched to wood stains.

Dilute the filler with a small amount of turpentine until the paste is like thin cream. Filler for oak should be a bit thicker and a bit thinner for woods like cherry, soft maple and redwood.

Work on a small area at a time. Apply with a clean, stiff brush, completely covering the area. Brush first with the grain, then across the grain.

Go over the surface with the palm of your hand, in a circular motion. Allow to dry until it loses its shiny appearance (about 20 minutes.)

Use burlap or other rough cloth to wipe across the grain to remove the excess filler. Then use cheesecloth or thin cotton to lightly go over the surface with the grain to remove what is left. You do not want to completely remove all the filler, just the filler that is sticking up out of the pores.

If necessary, add another coat of filler. Let it dry at least 6 to 8 hours. Then cover with shellac, varnish or lacquer.

CUTTING ANGLES

Mitred corners join pieces of wood together which have been cut on an angle. They are popular for picture frames and doorways. Mitred corners are often reinforced in some way.

Why Use Mitred Corners?

Mitred corners are attractive and show off decorative wood well.

The Mitre Box and the Mitre Saw are specially designed to cut precise angles so that mitred joints fit accurately.

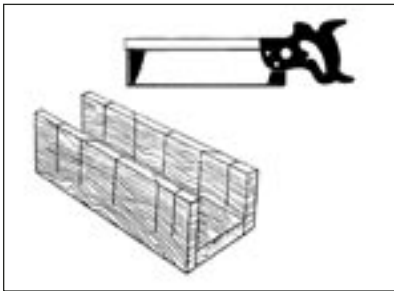

Tips for Accurate Sawing

- think your cuts through before you cut!
- hold the wood securely against the side of the mitre box
- clamp the mitre box to the work surface

Clamping a Mitred Corner

Cut a 90 angle out of a small piece of hardwood. Clamp this against a mitred corner while the glue is drying.

Care and Storage of Mitre Box and Saw

- put a thin piece of wood under the wood being sawn in the mitre box to protect the box
- keep the box clean and dry
- protect the box from items falling on it
- store the saw with the blade covered

Observe

This next week, look for mitred corners at home, school and out in the community.

- Where did you see mitred corners used?
- How strong did they appear to be?
- How attractive did they appear to be?
- Did you see any situations where a mitred corner should have been used?

Are mitred corners a relatively new development or have they been around for a while?

How can you answer this question with your own findings?

FINISHING

Some woodworkers are tempted to rush the finishing of projects. Yet it is the finishing that can make or break your project! Take the time to choose and execute your finishing technique. It will pay off.

The Benefits of Varnish

- shows off the grain and colour of wood
- looks more natural

Benefits of Paint

- can cover up flaws in the wood
- can cover up errors in workmanship
- can disguise wood filler
- can match existing furniture
- is often washable

Clean-up of Tools

It is important to clean up immediately after finishing. The longer you leave your tools and work area to dry before cleaning up, the harder the finishes are to remove. Each product will have its own instructions for clean up.

Paint brushes need to be absolutely clean before hanging up to dry, or they will be hard and totally useless to you next time.

Special Finishes

Splattering

Protect your work area. Apply a coat of primer and paint on your project. Let them dry completely. Use either an old toothbrush or small paintbrush to do the splattering.

Practice first! Choose a different color. Load the brush, scrape off the excess then pull the bristles back with a small piece of wood, so that the paint will spray. Or, you can tap the brush with a piece of wood.

Once you have mastered this technique to your satisfaction, splatter paint onto your project. You can make the splatterings as thin or thick as you like! You can also mask an area or use a stencil to produce a splattered pattern. Have fun!

Stippling

Use a stippling brush, marine sponge or paper towel on your project while the paint is still wet. You might want to practice this technique on something else first, but there is no wrong way to do it!

Rag Rolling

Roll a dry, clean ruffled rag through the paint! Doesn't that sound funny? You can also dip the rag into paint and then daub it onto a clean, dry surface. Try both!

Dragging

No, this does not require a car and a rope. Drag a comb tool through wet paint. Clean off the tool after each pass. This is especially attractive when you use a different color of wet paint over top of dry paint.

Marine Sponge

Dip your sponge into a bit of diluted paint, then wring it almost dry. Touch your project with the sponge, turning it in various ways. Try this with several colours!

Permanent Markers

Test your markers on a sample of the wood your project is made of, to see if the markers will spread or bleed into the wood. If it does and you do not like that, apply an acrylic sealer to the project first.

Markers work best on light woods. The wood grain often shows through markers.

Plan your design first, on a piece of paper exactly the same size as the project.

THINGS TO MAKE: **LEVEL TWO**

1. Bike Rack – keep your bike and helmet up out of the way
2. 4-H bookends – traditional, practical, memorable!
3. Firewood Rack – welcome accessory for home or cottage
4. Cookbook holder – this can hold any book, leaving your hands free
5. Sawhorse – a great thing to have. Better make two.
6. Magazine Rack – simple, clean, easy to move!
7. Tool Box.

Bike Rack

This rack holds a bike with a horizontal crossbar. The rack looks like a small book shelf, with two long supports that stick out and hold the bike's frame between the seat and handle bars. There is room for keys and a water bottle on the shelf and you can add pegs to hold your helmet.

Make a cardboard model of this bike rack first, so it is the correct depth for your bike and accessories. Making a model also helps prevent mistakes and waste.

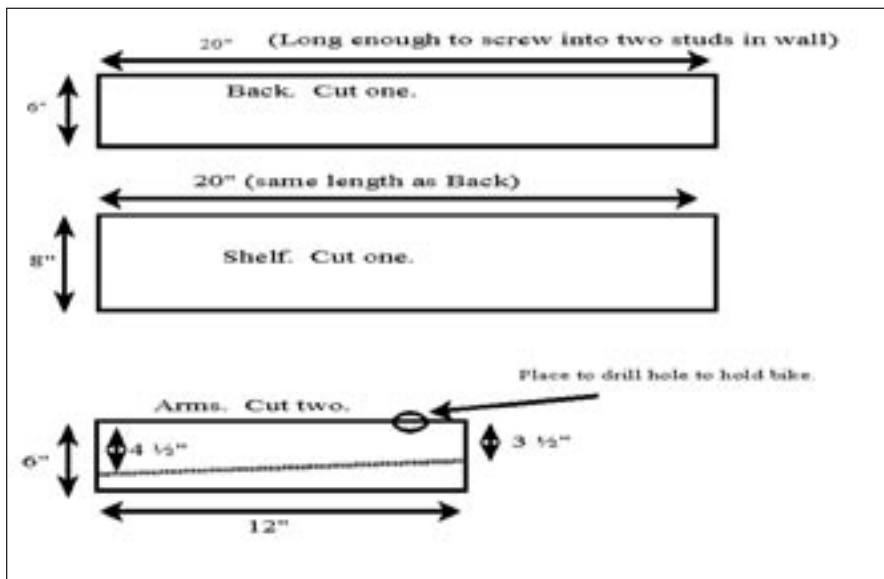

Plan to secure this to the studs in the wall. Find out how far apart the studs in the wall are. Build your bike rack to be slightly wider.

Materials

- 1 scrap 1x8, at least 24" long
- 1 scrap 1x6, at least 46" long
- 1 scrap dowel, at least 9" long
- 4 3/8" x 2 2" lag bolts, with washers (to attach it to the wall)
- 10 No. 10 x 1 2" flathead wood screws
- 6 d finishing nails
- wood glue
- sandpaper, 100-grit and 150-grit
- a jar lid, about 6" in diameter
- piece of wax candle (to rub on the screws)
- varnish
- paintbrush
- rags and newspaper
- turpentine or mineral spirits

Tools

- marking tools
- C-clamp
- handsaw
- hammer
- hand drill with 5/32" bit
- screwdriver
- coping saw
- brace with 3/8" and 1" bits
- rasp

Cut list

- 1 1 x 6 x 20" (The back)
- 2 1 x 6 x 12" (The arms the bike rests on)
- 1 1 x 8 x 20" (The shelf on top)
- 3 3/8" dowels, each 3" long (pegs)

Note that the back and shelf on top may have to be longer if you want to secure this to the studs in the wall.



Instructions

1. Make a cardboard model first.
2. Mark, clamp and cut the pieces listed.
3. Lay one of the supports on the work surface. On one end, mark a point 4 1/2" from the side. On the other end of the support, mark a point 3" from the side, on the same face of the support. Draw a line from one point to the other. The line will slope.
4. Clamp and cut on this line.
5. Repeat steps two and three for the other support.
6. To make a curved end on the support, trace the jar lid on the small end of the support, so that the line connects the supports two edges.

7. Clamp and cut with the coping saw. Use your rasp to smooth down the edge.
8. Repeat steps five and six on the other support.
9. Lay both supports on the work surface, with the top edges against each other. Put a piece of scrap wood under them. Clamp each piece so that they cannot possibly move! You might need an adult to help at this point.

On the joint between the two pieces, mark a point at 2" from the narrow end of the support. This is the point at which the bike frame will hang. (At the narrow end of the support.)

10. Drill a one inch hole with the brace and bit at the 2" mark. You will be cutting one hole, which will make a semi circle in each support. Neat, eh? Test that this hole is big enough to hold the frame of your bike.
11. Assemble the pieces to see how they will all go together.

With a helper, hold it against your bike to make sure the supports are the correct size. Is everything fitting together and making sense?

With a pencil, mark where the supports touch the back and sides. Determine where to drive the screws. With an adult helper, decide where to drill for the lag bolts.

12. Protect the work surface with scrap wood. Bore the marked holes using either the hand drill or brace and bit.
13. Sand all the parts with the sandpaper. Wipe off the dust.
14. Glue and screw the wide ends of the supports to the back of the bike rack. The top edges of the supports should be even with the top edge of the top edge of the back.
15. Glue and screw the shelf to the back and the supports. Avoid getting glue on the parts of the support which will be exposed.
16. Put a drop or two of wood glue into each peg hole. Tap or push a peg into each hole.
17. Sand the project carefully. Wipe off the dust and finish the bike rack with varnish.
18. When your bike rack is 100% dry, mount it at an appropriate height, on a wall using the lag bolts.

If you are making this as a gift for someone, have that person help decide at which height you should install the rack.
19. Take a picture. Write this accomplishment in your record book! Congratulations!

4-H Bookends

Materials

- 1 18 mm x 135 mm x 900 mm (wood or plywood)
- 14 38 mm finishing nails
- sandpaper
- paint or varnish

Tools

- crosscut handsaw
- coping saw
- hammer
- eye protection

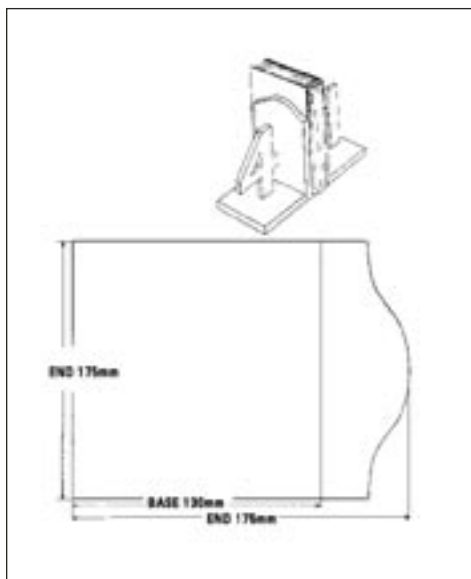

Instructions

1. Cut two bases 135 mm by 130 mm with the crosscut saw.
2. Cut two ends 135 mm by 175 mm with the crosscut saw.
3. Trace the rounded tops of the ends and cut with the coping saw.
4. Trace the 4" and the H. Cut these out with the coping saw.
5. Sand all the pieces smooth.
6. Glue and nail the ends to the bases.
7. Glue and nail the 4" to the left side bookend. Glue the H to the right side bookend. (Otherwise you will have a H-4" bookend.)
8. Varnish or paint your project.
9. Have someone take your picture with your bookends. Congratulations!

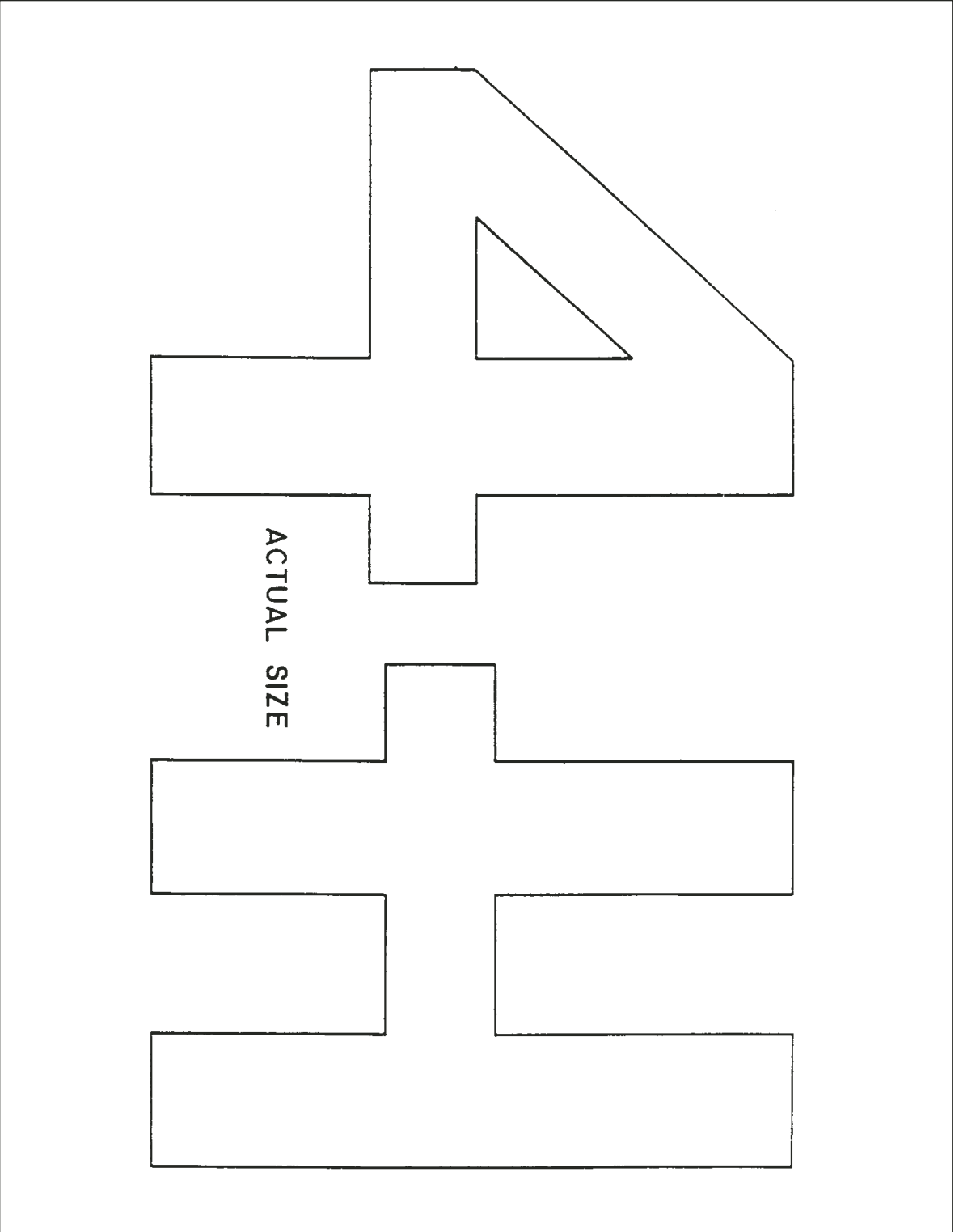

Firewood Rack

Materials

- 2 38 mm x 190 mm x 610 mm (base)
- 2 38 mm x 190 mm x 610 mm (base)
- 11 19 mm x 64 mm x 450 mm (slats)
- 26 38 mm #8 screws
- glue
- sandpaper
- outdoor stain

Tools

- jigsaw
- crosscut handsaw
- drill
- clamps
- screwdriver
- string and pencil
- clamps

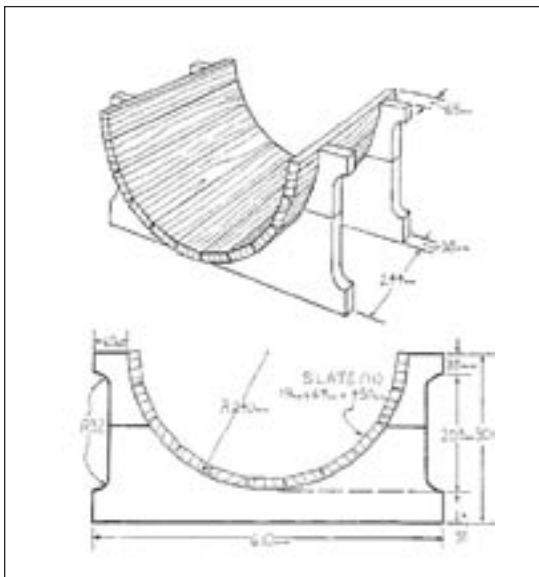

Instructions

1. Glue one 38 mm x 140 mm piece to a 38 mm x 190 mm piece to make one piece of wood that is 38 mm x 330 mm x 610.
2. Repeat step one.
3. Cut the glued pieces of wood down to 38 mm x 300 mm x 610 mm.
4. Using the string and pencil, nail the string to the middle of the top side (at 305 mm). Tie the pencil at 240 mm in the string. Draw a half circle with the pencil on the wood.
5. Repeat for the other base piece.
6. Cut out the half circles with the jigsaw.

7. Draw a cut at each end of the frame pieces that measure 200 mm by 32 mm, with rounded corners. You can use a jar lid for tracing the rounded corners. Cut these out with the jigsaw. (This step is for appearances only, but it does look better than a straight end.)
8. Sand all the wood to remove sharp or splintering edges.
9. Clamp the base pieces so they are 244 mm apart from each other (measuring from the inside edges). If you do not have clamps, you could carefully nail or screw them to 2 x 4's from below at the correct distance. Then remove the 2 x 4's after all the slats are attached.
10. Drill two pilot holes at each end of two slats at 78 mm. These will be the top slats.
11. Drill pilot holes 78 mm from the end of all the other slats, in the centre of the slat.
12. Glue and screw the slats in place, starting at the bottom and alternating sides as you work your way upwards. The slats should stick out 65 mm past the end of the base pieces at both ends. (See diagram.)
13. Sand and wipe.
14. Stain your firewood rack with a tough outdoor stain. Or you can leave it plain, if that's your pleasure.
15. Take a picture for your record book. Congratulations. I bet it looks nice.

Source: Saskatchewan 4-H Unit Two : The 4-H Woodworker.

Cookbook Holder

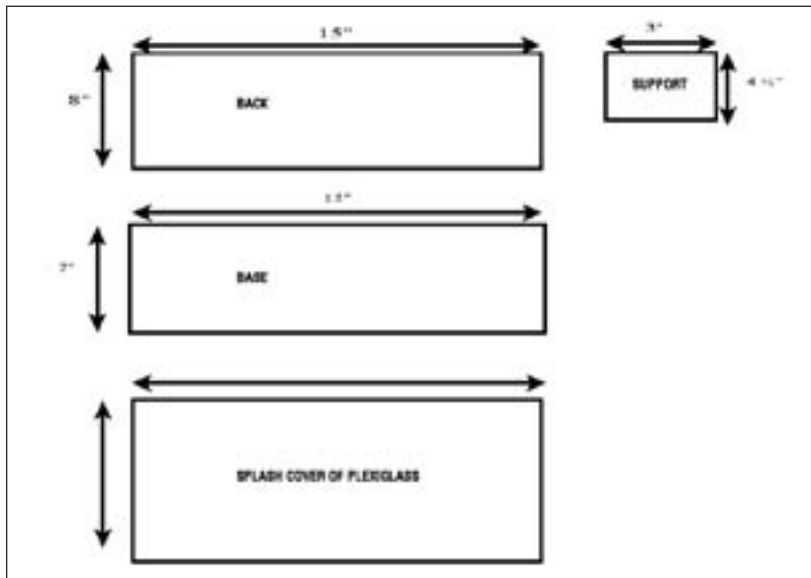

Materials

- 1 2 x 15 x 8" (back)
- 1 3/4" x 7" x 15" (base)
- 1 3/4" x 3" x 4 1/2" (support)
- 1 1/8" x 12" x 15" (splash cover of plexiglass)

Tools

- circular saw
- jigsaw
- jar lid
- sander

Instructions

1. Measure and cut all the wood and the plexiglass. Sand lightly. Wipe.
2. Cut the bottom edge of the base to an angle of 15 degrees. This allows the book to slant back, so it will not fall forward.
4. Mark out where the slots should be in the base, to hold the back and the piece of plexiglass. These slots will also be cut at a 15 degree angle, so that the plexiglass will also slant backwards and hold the book pages open. You will cut four slots for the plexiglass, to accommodate various thicknesses of books.
5. All the slots will be 1/4" deep.
6. The slot for the base should be the width of the back so it will fit snugly. The slot for the plexiglass should be 1/8" wide. Space the slots for the plexiglass evenly between the front and the slot.
7. Check before you cut that you will be cutting the slots angling towards the back, not the front!
8. Cut the support piece. This piece is also angled at 15 degrees.
9. Screw the support piece to the base, making sure the back support is lined up with the slot for the base.

10. Apply glue to the sloped edge of the back support, as well as in the 2" slot.
11. Put the back piece in place. Clamp together overnight.
12. Use a finishing oil on the cookbook holder.
13. Cut out the piece of plexiglass. Round off the top edges. Sand down the edges to smooth them
14. Take a picture for your record book. Congratulations.

Note: You could cut out a decorative shape, such as a heart, out of the top centre of the holder. Rasp and sand it well.

Sawhorse

Materials (for sawhorse with 24" legs)

- 1 2" x 4" x 12' (sound wood, free from splits, knots or other weakening defects) for the legs and the beam
- 1 piece 1" x 6" x 24" – for the support under each end of the beam
- 8 No. 14, 3" flathead wood screws
- 20 No. 12, 2" flathead wood screws
- 20 4d finishing nails
- Colourless penetrating wood finish, such as boiled linseed oil or varnish with paint thinner or commercial wood seal

Tools

- hammer
- crosscut saw
- screwdriver
- countersink
- combination square
- sandpaper
- tape rule
- T bevel
- plane

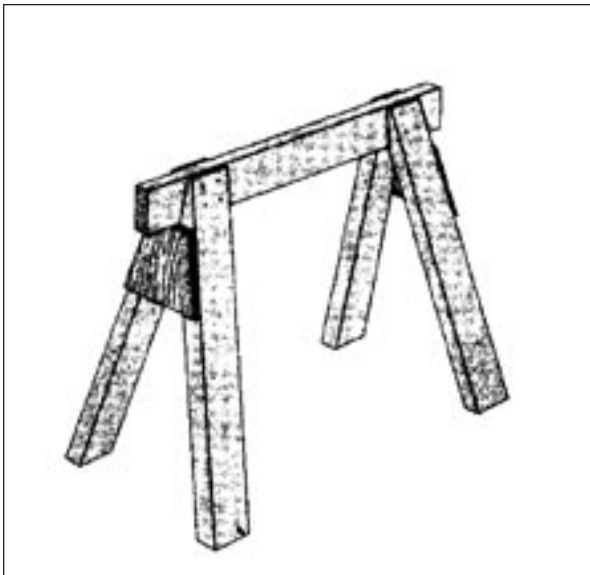

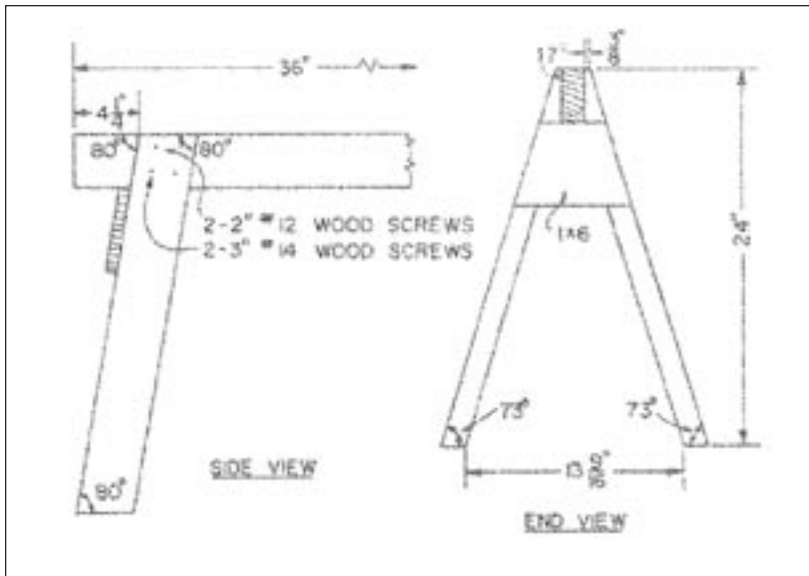

Instructions

1. Lay out and cut all pieces. Refer to the diagram for the angles of cuts on the legs.
2. Assemble sawhorse as shown with nails.
3. Drill pilot holes and install screws.
4. After all the legs are marked and cut out, cut 1 1/4" off the tapered end to give a narrow, flat end section. The flat end section will be flush with the top of the beam
5. Sand lightly.
6. Finish with your chosen finish.

Note: To make a sawhorse even sturdier, add supports on the inside of the legs too.

Source: National 4-H wood Science Committee. Building Bigger Things. Chevy Chase, MD. : National 4-H Council of the United States of America, 1987.

Magazine Rack

This design goes together quickly. A slot in each piece fits into the other to form a sturdy, yet simple rack. Comes apart easily for moving. A great gift idea for someone's dorm room or first apartment!

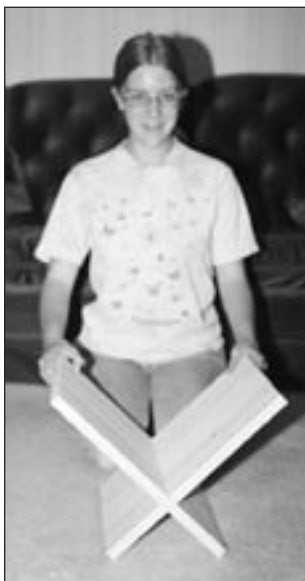
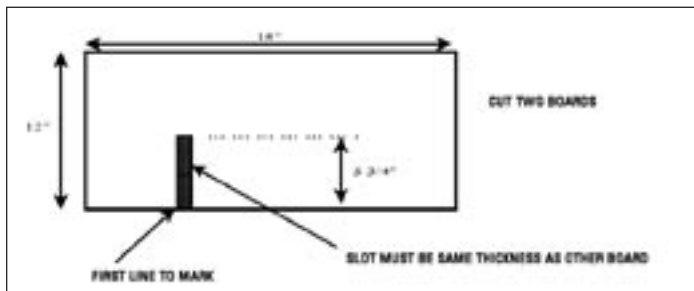

Materials

- 1 scrap of 1 x 12", at least 32" long (or glue and clamp together some 1 x 6)
- sandpaper, 100-grit and 150-grit
- varnish
- mineral spirits or turpentine
- 1" paintbrush
- rags and newspaper

Tools

- measuring and marking tools
- C-clamp
- handsaw
- coping saw
- rasp

Cut List

- 2 1 x 12 x 16" sides

Instructions

1. Square the end of the wood.
2. Cut two 16" long pieces from the 1 x 12.
3. Lay one piece on the work surface. You are going to mark where to cut the slot. This slot has to be the actual thickness of the other board. Measuring from one cut end, mark a point at 5 inches. Mark a second point which will be at 5 inches plus the thickness of the second board.
4. Measuring from the edge of the piece, lightly draw a line through each of the marks you just made. You will have two lines parallel to each other.
5. From that same edge, measure and mark a point $5 \frac{3}{4}$ " down, between the two faint lines. Connect the two lines across this point, using your try square to make sure the line is square.
6. Clamp the wood to the work surface. Cut the two faint lines with the handsaw, up to the latest line which crosses the two lines. Tip your saw up at the end of the cut, so that the cut will have a square end.
7. Cut along the short line with the coping saw. You may have to drill a small hole so you can turn your coping saw to point the right way. Sand the rough inside edge with the rasp and then the sandpaper.
8. Repeat steps two to seven with the other piece of wood.
9. Slide the two slots together. The longer ends of the wood should be on top, so the rack will hold more magazines.
10. Separate the sides. Sand all surfaces. Wipe away the dust.
11. Give each side at least two coats of varnish, sanding lightly between coats.
12. When the sides are completely dry, put them together. Have someone take your picture with your new magazine rack. Congratulations!

Toolbox

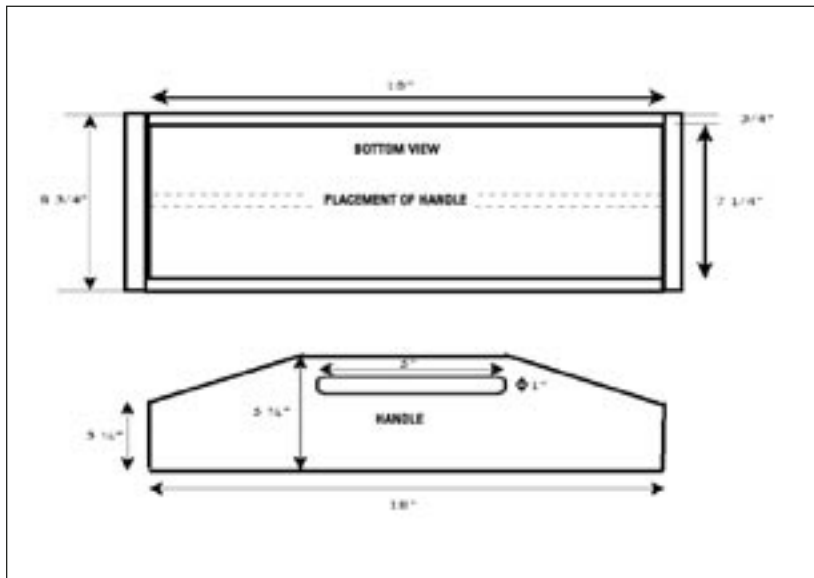

Materials

- 1 1" x 8" x 18" (bottom)
- 2 1" x 4" x 18" (Sides)
- 1 1" x 4" x 10" (Ends)
- 1 1" x 6" x 18" (handle)
- 4 #8, 1 2" flathead wood screws
- 25 #8, 2" flathead wood screws
- fine grit sandpaper

Tools

- saws
- screwdriver
- round wood rasp or file
- drill with 1" bit
- pilot hole bits to fit screws and countersink

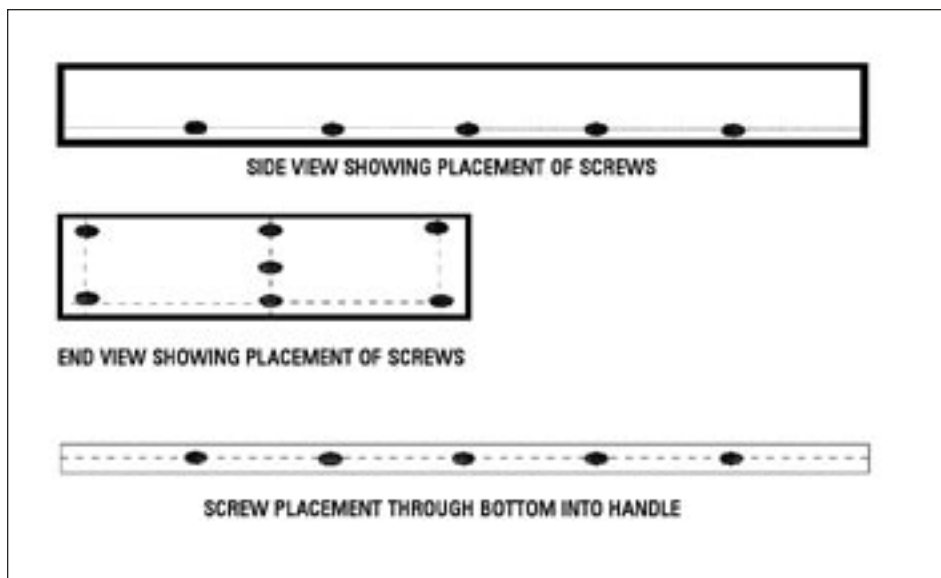

Instructions

1. Cut pieces to size (see diagram).
2. Mark and cut the angled cuts on the handle, leaving 1/16" or so for sanding.
3. Mark the handle hole. Bore a 1" hole at each end of the mark and saw out the rest. Use the rasp or file to even and round out the edges. Sand and smooth all sides and edges.
4. On the 8 x 18 bottom piece, draw a centre line lengthwise. Mark and drill countersink holes every three inches on this line. Sand smooth all sides and edges. Screw the bottom to the handle with 2" screws.

Tip: When use slotted screws, line up all the slots the same way. It looks more professional.

5. In the side pieces, drill the countersink holes 3/8" from the bottom edge. Space the holes as shown on the diagram. Sand smooth all sides and edges. Use 2" screws to fasten both sides to the bottom piece.
6. Add the ends in the same way. Use 1/2" screws at the bottom corners so you do not hit the screws holding the side pieces.
7. For extra strength, drill and countersink the holes in each end piece to hold the handle. Use a 2" screw in each hole.
8. Paint or stain your tool box to personalize it.
9. Take a picture for your record book. Congratulations! Enjoy using your new tool box.

I CAN: LEADER'S SIGNATURES

Leader Signature

Safety

- Meet all safety objectives of level two. _____
- Ask another member to stop if I see unsafe practices or hazards. _____
- Explain and demonstrate safe shop practices. _____
- Recall and practice safety procedures. _____
- Locate first aid kit. _____
- Locate closest phone. _____
- Recall the phone numbers for emergency help. _____
- Explain and demonstrate safe handling procedures of new tools and materials. _____
- Can evaluate equipment for dust management. _____
- The nature of wood. _____
- Identify at least five types of wood and suggest uses for them. _____
- Demonstrate how to remove dents in wood. _____
- Apply knowledge of wood characteristics when selecting wood for a project. _____

Drawing for Building

- Explain benefits for drawing before building a project. _____
- Draw isometric and orthographic drawings of a simple project, including measurements. _____
- Accurately find points on drawing that match points on an object. _____

Tools

- Be able to transfer a drawing pattern onto wood. _____
- Accurately enlarge a pattern. _____
- Identify and explain use of chisels, power drill, power sander, jigsaw, brace and bit. _____
- Explain/demonstrate safe handling of above named tools. _____
- Use tools to complete a project. _____
- Care for and store tools properly. _____

Using Screws

- Explain why we would use screws instead of nails. _____
- Identify at least two different types of screws and their use. _____
- Name the parts of a screw. _____
- List advantages/disadvantages of types of screws. _____
- Explain and demonstrate how to put a screw into wood without splitting or breaking the wood. _____
- Explain the sizing of screws (gauge). _____
- Given two pieces of wood to be joined, select the correct size of screw to be used. _____
- Select the right size of screwdriver to be used. _____
- Explain and demonstrate how to avoid stripping screws or ruining the head. _____
- Demonstrate how to cover screws in a finished project. _____

Measurement Tools

- Identify and demonstrate accurate use of a try square. _____
- Identify and demonstrate accurate use of a steel utility square or framing square. _____
- Identify and demonstrate accurate use of a steel combination square. _____
- Identify and demonstrate accurate use of a pencil compass. _____
- Identify and demonstrate accurate use of a scratch awl. _____

Glue

- Explain how glue works. _____
- Select appropriate glue for a job. _____
- Demonstrate correct gluing technique. _____
- Explain how glue can affect finishing. _____
- Demonstrate safe and economic clean up and storage of glue. _____

Sanding

- Identify orbital, belt and straight sanders and their advantages/disadvantages. _____
- Explain how each type of sander works. _____
- Select appropriate sander for the job at hand. _____
- List and demonstrate dust management techniques. _____
- List sources for additional information on dust management. _____

Cutting Angles

- Explain and demonstrate the use of a mitre box to cut angles of various degrees. _____
- Identify situations for use of mitred corners. _____
- Share tips for accurate cutting. _____

Finishing

- Explain differences between paint and varnish and how to decide which product to use. _____
- Provide for adequate ventilation while using finishing products. _____
- Give three tips re: finishing. _____
- Demonstrate care and clean-up of tools and materials. _____
- Explain/demonstrated how to hide nail or screw holes. _____
- Demonstrate at least one of: splattering, stippling, rag rolling, dragging, use of a marine sponge, use of permanent markers as decorative finishes. _____
- Dispose of used rags in a safe manner, to prevent fire. _____

LEVEL THREE: MEMBER'S MANUAL

Objectives

Members will be able to:

- Work safely with wood to produce personal projects made of wood.
- Identify and use woodworking tools and supplies in a safe manner.
- Challenge themselves with a variety of projects and varying levels of complexity of tasks in woodworking.
- Work cooperatively with others in a workshop environment.
- Develop skill in decision making, leadership, problem-solving, finances and communication.

Achievement Day Requirements

Level 3

- Completed Record Book
- At least two completed projects which use different types of joints and which required the use of power tools studied in this project.
- Plans drawn by the member for a personal project. Cardboard model of intended project.
- Item made by the member which required the use of a router.
- Display of tools sharpened by the member. (Chisels, screwdrivers etc.)

Additional Resources for Learning

People

- local woodworkers
- teachers
- family members
- other 4-H members or leaders

Places, Events and Organizations

- local woodworking clubs
- exhibitions and fairs that have a woodworking class
- colleges that offer woodworking, design, or similar courses
- displays
- museums sometimes have displays with wooden articles

Things

- books or magazines
 - *Canadian Home Workshop*
 - *Woodworkers Journal*
 - *Wood Magazine*
 - *American Woodworker*
- furniture
- buildings featuring wood

Web sites

www.thewoodcrafter.net
www.leevalleytools.com
www.woodworkershop.com
www.intheworkshop.com
www.uniqueprojects.com
www.am-wood.com (Amateur Woodworker)
www.northpolechristmas.com
www.tdc.ca/ewebster.htm
www.feesa.ab.ca
www.woodlinks.com

SAFETY: LEVEL THREE

Learning Objectives

Members will be able to:

- meet all safety objectives of levels one and two
- identify and deal appropriately with shop hazards - physical, mechanical, chemical, electrical and human
- encourage safe behaviour in other people
- show leadership by working and playing safely
- teach safe procedures to other members
- select personal protective devices according to task at hand
- determine if safety shields are in place by visual inspection
- locate shut offs for power tools
- operate shut offs

Prepare for the Meeting

- Review personal work habits.
- Prepare any flip charts required.
- Gather examples of tools.
- Prepare for Hazard Hunt, if you will be doing one.
- Complete your own personal Safety Contract.
- Gather and display personal protective equipment.

During the Meeting

- Ask the members to work together to list preventative actions for dealing with risks.
- Review advice they would give other woodworkers.
- What are the possible consequences of not following safety rules? What would be the realities of those consequences for the members and their families?
- Complete the flip chart (page in members manual) Who does an unsafe worker affect?
- Help members fit eye and dust protection equipment.
- Ask members to demonstrate/practice proper lifting technique.

Safety in the Woodworking Project

List as many preventative actions as you can for the following risks:

AT RISK	RISK	PREVENTATIVE ACTION
EYES	Flying chips Dust Splashing finishes Splinters from breaking tools Fumes Compressed air used improperly	
EARS	Exposure to loud noises	
LUNGS	Exposure to very tiny dust particles (less than 10 microns) Exposure to fumes from finishes Inadequate ventilation	
SKIN, FINGERS, LIMBS, HANDS AND FEET	Punctures, rips from tools and rough wood. Crushing Pinching Exposure to chemical finishes Abrasions Burns from hot tools	
BACK	Lifting too much Falls from tripping over materials Turning incorrectly Lifting incorrectly	

You must purchase your own personal safety equipment for the 4-H woodworking project. Eye protection must be worn.



Who does an unsafe worker affect?

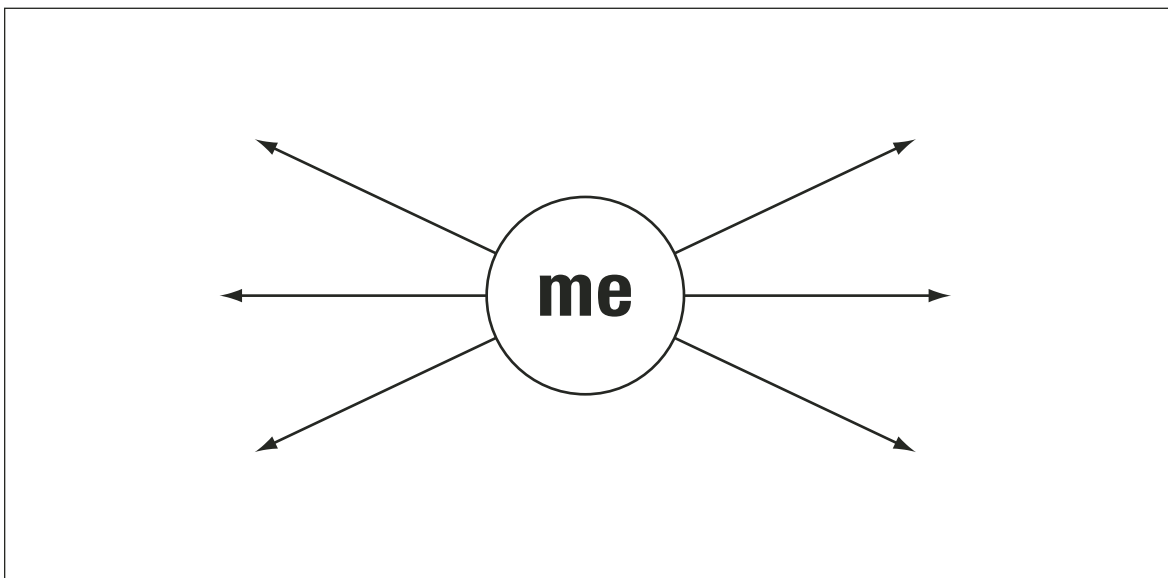

Safety Steps

1. Name the risks
2. Safeguard the work area.
3. Wear necessary protective equipment.
4. Use the right tools.
5. Follow correct procedure.
6. Monitor work habits.
7. Correct as necessary.

Ensure all helpers follow safe procedures

- Where are the First Aid kits kept at your 4-H meetings?
 - Where are all the First Aid kits at home?
 - Who has First Aid training in your 4-H club?
 - Who has First Aid training in your family?
 - What phone number do you call for emergency help?
 - What are the directions to drive to your meeting place? (in case you ever had to give them to emergency people)
 - What are the directions to get to your home? (In case you ever had to call emergency people)
- Post these by all the phones in your home or shop.

Contents for a Basic First Aid Kit

A variety of bandages; antiseptic; tweezers; First Aid booklet; cotton swabs; sterile gauze; First Aid tape; needles (to get out slivers); eye drops.

SAFETY CONTRACT

I Will:

- identify risks of activities
- take actions to eliminate or reduce risk
- ask for help when needed
- select the correct tools, equipment and materials for activity
- watch for and allow for closeness to other people
- stop work and move back when ask to
- exit work area on command (in case of emergency)
- return tools and supplies to storage after use
- follow safe disposal procedure
- dress appropriately for club activities
- share responsibility for safety in the club

Member
_____**Parent**
_____**Leader**
_____**Date**

FORESTRY INDUSTRY

Objectives

Members will be able to:

- identify forestry as one of Alberta's major industries and employers
- trace the route of wood products from wood lot to consumer
- name at least five careers linked to forestry and the preparation for that career
- list sources of information on the forestry industry

Facts On Forestry

- Canada is the world's largest exporter of wood and wood products
- forest products were one of the largest contributors to the surplus balance of trade for Canada in 2001
- Canada has 10% of the world's forests
- 60% of Alberta is covered by forest
- The forestry sector provides approximately 54,000 jobs in Alberta
- The forestry sector generates \$1.6 billion in household income in Alberta
- The forestry sector is the primary industry in at least 45 communities in Alberta

Forestry Related Career Opportunities

- Research and development
- Logging
- Trucking and other services
- Manufacturing of forestry products
- Environmental protection
- Fire protection

Training and Education Opportunities re: Forestry

- University of Alberta – Faculty of Agriculture and Forestry
- Junior Forest Rangers Program – Alberta Sustainable Resource Development
- NAFA (National Aboriginal Forestry Association)
- Alberta Forestry Advanced Management Institute (Hinton)
- Silviculture Institute of British Columbia
- Lakehead University, Thunder Bay

Visit www.woodlinks.com for additional information on forestry careers.

DRAFTING, DRAWING & DIMENSIONING

Isometric Drawings

- Shows what an object would look like from one side and a bit below your eyes (like looking down at something sitting on a table)
- Is helpful for getting an idea of what the project will look like
- Helps indicate what type of materials will be needed

Sketch an example of an isometric drawing here.

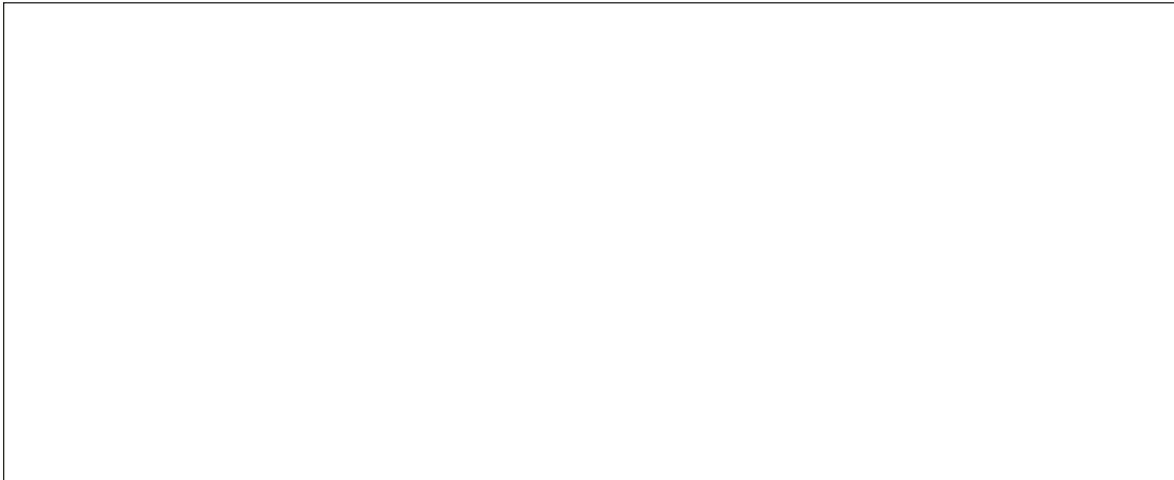

Orthographic Drawing

- This type of drawing splits the object into different views: the top, the sides and the front
- An orthographic drawing is drawn accurately and to scale*

** to scale means that each measurement on paper is in proportion to a measurement in real life. e.g. One cm on paper represents 10 cm in real life.*

Sketch an example of an orthographic drawing here.

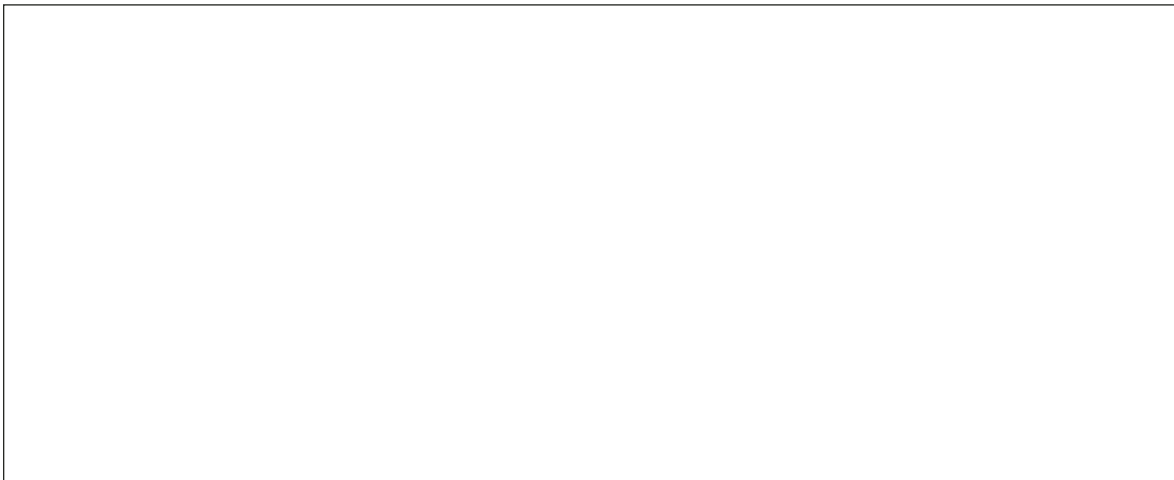

Sources of Plans, Patterns

Web sites

www.thewoodcrafter.net
www.leevalleytools.com
www.woodworkershop.com
www.intheworkshop.com

Books

Check out the library!

Your Imagination

And, best of all your own head!

Someday you will need a special item for a particular spot. You may look in stores or catalogues to see if the right thing is out there for sale. Then it hits you! I can make this myself! Here's how to do it.

Custom Designs by Me

1. Decide what you want this project to do for you. What are the requirements of the project?
Let's say you want to build a shelf for your school locker. There will be size limitations. It will have to be a certain strength. Do you want it to be adjustable, so you can move it up and down? Will you have to assemble it after you have put the pieces in the locker or can you preassemble it at home? Do you plan to store heavy or light objects on this shelf?
2. Take measurements of the space to be occupied by the project. Measure your locker door. Measure the inside of the locker.
3. Make both isometric and orthographic drawings of the project. This step helps you think through the building and use of the item.
4. Make a paper or cardboard model of the project. Test it in the space that you intend to use the actual article. Many design problems are detected at this stage! It is a lot cheaper to discover a mistake with a paper model than it is with an expensive wood object!
5. Make any necessary design changes. Repeat your test.
6. Transfer your pattern to wood. Proceed with building the real article.
7. Install, use and appreciate your custom designed project.
8. Take a picture for your record book!

JOINERY

Objectives

Members will be able to:

- identify at least three different joints and explain how they are made
- identify tools used for specific joints
- construct a project using a new type of joint
- select jointing techniques according to strength, appearance
- glue and clamp a joint for maximum strength and best appearance

Prepare for the Meeting

- gather pictures or examples of joints
- invite members to bring items they have made, to show types of joints used
- provide for practice at making joints either on scrap or projects
- prepare flip chart with types of joints listed (optional)

At the Meeting

- review types of joints.
- ask members to identify types of joints on actual examples
- discuss with members the types of joints they will use in their projects
- members work on personal projects

Alternative Activities

- members identify types of joints used in wooden articles at home, school or public places
- members compare the joints in older furniture to those in modern furniture
- tour furniture store, furniture factory, historic buildings or museums.

Dovetail

A variety of joints have been designed and used by woodworkers. They vary in procedure, strength, appearance and skill required to make them. Some of the techniques used by pioneers with crude tools are still holding today!



When buying wooden furniture, the quality of joints used indicates the strength and quality of the furniture. The better quality the joints, the more expensive the furniture. You will make at least two different types of joints for this project.

Different joints are suitable for different purposes. Choose the correct joint for your project. Then, construct it properly. Glue and clamp it securely.

Butt Joint

This joint is the easiest and also the weakest. It is usually the first joint most of us make. You might see this kind of joint in a bird house or feeder, because those items do not need extremely strong joints. Sometimes the butt joint is reinforced by dowels or corner braces.

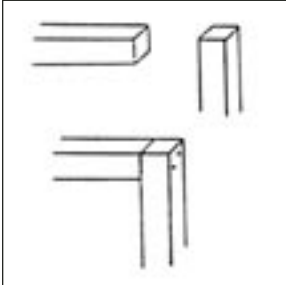

Examples of butt joints in woodworking: _____

Mitre Joint

The mitre is a type of butt joint. The wood is cut at a precise angle using a mitre saw and mitre box.

It looks better than a butt joint and is a bit stronger. It can be tricky to clamp.

Picture frames and door frames often use this type of joint because it is a good way to join ornamental wood. You will notice that picture frames are pinned or reinforced at the corners for extra support.

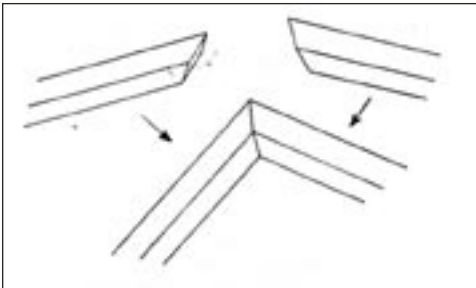

Examples of mitre joints in woodworking: _____

Rabbet Joint

This type of joint is often used for drawer fronts in cabinet work. A cut is made at the end of a board so it will fit into another one.

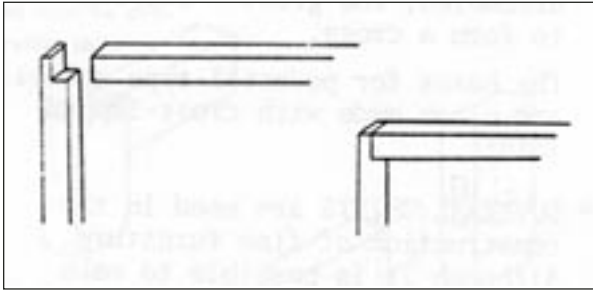

Examples of rabbet joints in woodworking: _____

Dado Joint

A dado joint is like a rabbet joint, except that the joint is made in the middle part of the board, not the end. This is a strong joint, because there is a lot of surface contact. Dado joints are used to make slots for shelves and other spots needing good support.

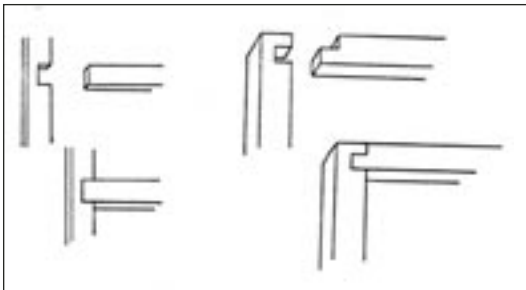

Examples of dado joints in woodworking: _____

Dowelled Joint

Pioneers used to make their own dowels to avoid having to buy nails. Dowels are hardwood pins that come in a variety of sizes. Holes are drilled and lined up to fit dowels tightly.

A dowelled joint may be any joint that is reinforced with dowels (short, round pegs). Butt joints are the most frequently dowelled joint. Most table legs are attached to the frame with dowels.

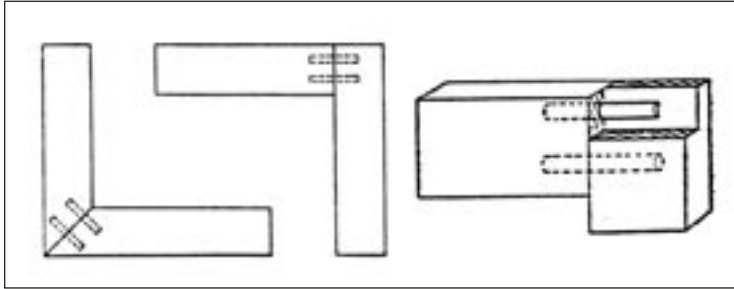

Examples of dowelled joints in woodworking: _____

Sometimes dowels snap off at a point of stress. (This is why people tell us not to tip our chairs.) The old dowel has to be removed (with a drill or careful chiselling), the hole cleaned and reglued. The replacement dowel is sometimes a bit larger than the original.

The types of joints I like the appearance of:

The types of joints I appreciate for their strength:

The types of joints I am going to practice making:

POWER TOOLS

Objectives

Members will be able to:

- identify tools accurately
- explain purpose of each tool discussed in this unit
- explain and demonstrate the use of each tool
- explain safety precautions for each tool
- compare various models
- demonstrate safe use of tools
- ask for help if unsure
- ask another member to stop if they see unsafe practices or hazards.

Prepare for the Meeting

- arrange for tools
- provide scrap wood for practice
- ensure members have personal protection equipment
- arrange for examples of projects which required the tools

At the Meeting

- introduce each tool in turn, outlining its use, safety and care
- demonstrate (this could be done by an experienced member or an adult helper)
- allow for supervised practice by members
- members work on their projects
- members make a name sign to practice use of a router

Alternative Activities

- tour or virtual tour of woodworking supply houses
- compare tools in catalogues

Router

This is a great tool that can accomplish all kinds of decorative and functional work. It is designed to cut across and along wood edges. Examples of router work include table edges, signs, grooves and clean cut holes.

Routers spin at speeds up to 24,000 revolutions per minute (RPM). Compare that to a drills 3,000 RPM! It is very important to secure the bit before starting up the router.

As with any tool, do not force a router. Forcing a router can ruin the bit and damage the motor. Especially when working with hard wood, it is often necessary to take more than one pass to remove the amount of wood you want.

Routers use interchangeable bits so that you can make a variety of patterns in the wood. These bits are very hard, very precise and usually very expensive! Cheap bits are just that. Cheap.

When choosing bits, think about all the uses you will have for that design. Most woodworkers start out with the edge round and a straight bit.

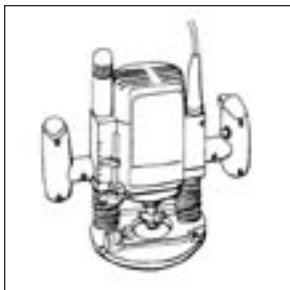

Practice using a router with the bits available to you. Which patterns do you like? Which patterns would work for your project?

Practice Using a Router – Name Plate

Materials

- always use eye or face protection
- a router and a straight bit, 2mm or 3mm
- wood, 2cm by 20cm by 50cm
- pencil
- clamp
- stencils (optional)

Procedure

1. Check that the bit is secure and set to a 2mm or 3mm depth.
2. Print a name or word on the wood in letters so it suits the dimensions of the wood. You can make a sign that says shop, office, keys, Grand Poobah or whatever you like. If you wish, use stencils to outline the letters. Remember that the router will remove quite a bit of wood. Leave space between each letter.
3. Clamp the wood to a bench or place it in a vice with the top edge just above the vise edge.
4. Operating a heavy router is tiring. If you get tired, stop.
5. Hold the router over the board so that the bit is right over the first letter. The router should be tilted so that edge touches the board.
6. Start the router. Slowly lower the router into the letter space you want to dig out. Cut out the outline of the letter first, then go back and clean out the insides. Some people like to just outline the letters and not clean out the insides.
7. Paint or stain your letters and the wood around them. One technique used by campgrounds is to paint the letters one colour and paint the flat wood another colour with a roller.

Bandsaw

The bandsaw is an impressive stationary power tool. Its blade is a loop of steel with teeth on one edge. The blade is driven and held in place by two large wheels. The wheels and most of the blade are covered by metal shields. The blade runs through guides to keep it straight.

A bandsaw is something like a granddaddy jigsaw - it cuts straight or curved lines at a tremendous speed. The blade cuts in a continuous downward stroke at a high speed. It cannot tell the difference between fingers and wood, so watch your work!

To use the band saw, you push the wood slowly into the blade. Cut corners and tight turns slowly and carefully. If you put too much stress on the blade it can break. One way to tell you are stressing the blade, is

that it starts to make a different sound. You can also smell the wood getting hot.

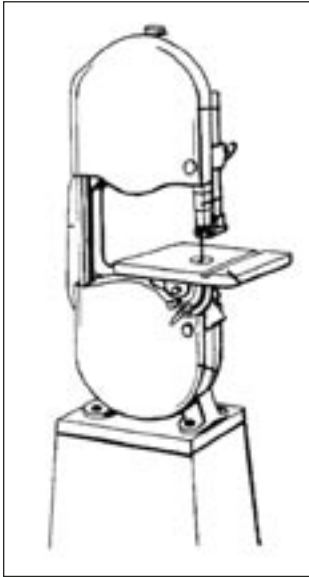

Drill Press

A drill press is a large stationary tool that operates at high speed. You bring the drill bit down to the wood with a downward pull of a lever. A drill press uses a variety of sizes of bits which need to be secured before use. Ensure that the key is removed before turning on the drill.

To ensure that the drill bit goes completely through the wood, raise or lower the drill table accordingly, and place a block of scrap wood under your project.

Always place a piece of scrap wood under your project. This protects the drill bit from hitting the table. It also prevents splintering on the back of the wood you are drilling.

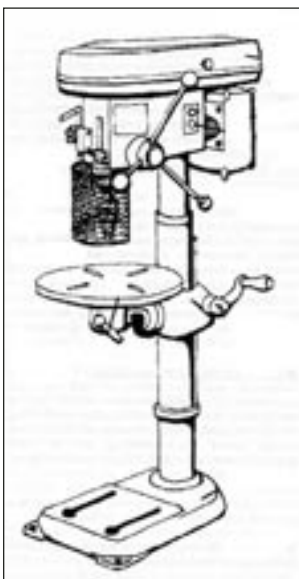

Safety Notes

1. Secure long hair. Do not wear loose clothes.
2. Before using the drill, always check to see that the last user removed the tightening key!
3. Hold the piece of wood you are working on securely. Otherwise, it might whirl around and whack you.

Stationary Belt Sander

The stationary belt sander is another versatile, powerful tool. Many stationary belt sanders also feature a disc sander attached to the front. The disc is helpful for squaring ends and sides of wood pieces. As this is a high speed machine, exercise great caution when using it. It can sand your fingers as fast as a piece of oak.

Use a stationary belt sander to square or round edges of wood parts. You can also shape smaller parts of wood with this machine.

When pushing wood into the belt, push slowly so you do not overtax the machine. When putting pressure on the belt, move the wood from side to side so the belt does not heat up or wear out on one spot.

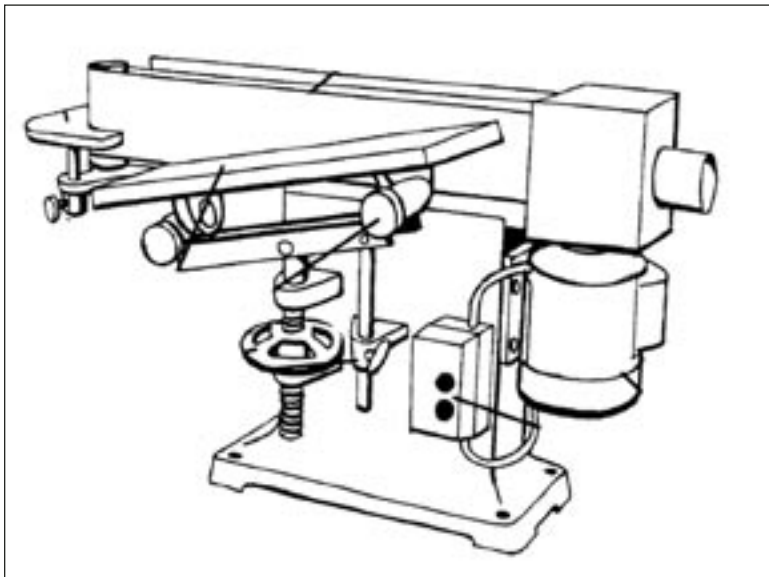

Radial Arm Saw

You will often see a radial arm saw on construction sites. It is used most often as a cut off saw (to cut wood to certain lengths). Radial arm saws can make exact duplicates of a cut, which makes it a very popular saw. The wood is held against the backstop with the left hand while the operator pulls the saw with the right hand.

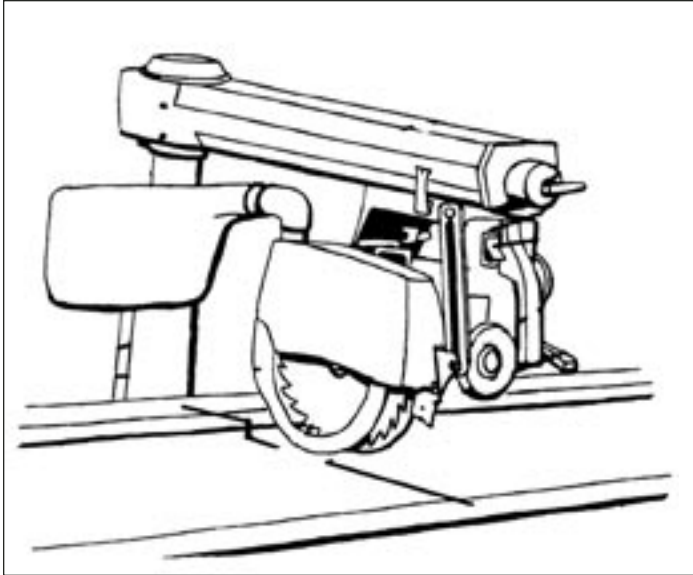

To Use the Radial Arm Saw

1. Wear safety goggles or a safety face shield. Ear muffs are also a good idea.
2. Keep appendages away from the blade. Use a push stick to push wood past the blade.
3. Put your wood against the backstop so that the cut line lines up roughly with the blade. Do not turn the saw on yet. Bring the saw blade down to touch the wood. Line the wood up so that the blade will cut on the waste side of the cut line. This is usually to the right of the line.
4. Slide the blade back. Hold the wood firmly. Turn the saw on. Draw the saw slowly and firmly towards yourself.
5. Turn off the saw. Admire the clean cut you have made with a radial arm saw.

Table Saw

This is a machine for the serious woodworker. It features a smooth steel surface and a blade that can be raised or lowered and tilted! On one side you will notice a rip fence which you use to cut boards to an exact width. The blade has a protective guard.

The push through device is also a mitre gauge which you can use to move wood into the blade at a specific angle. The angle can be set anywhere between 45 and 90 degrees.

The on/off switch should be in an easily accessible spot. The Off button is usually red. Always take note of the position of the Off or Kill button or switch button before you use a machine.

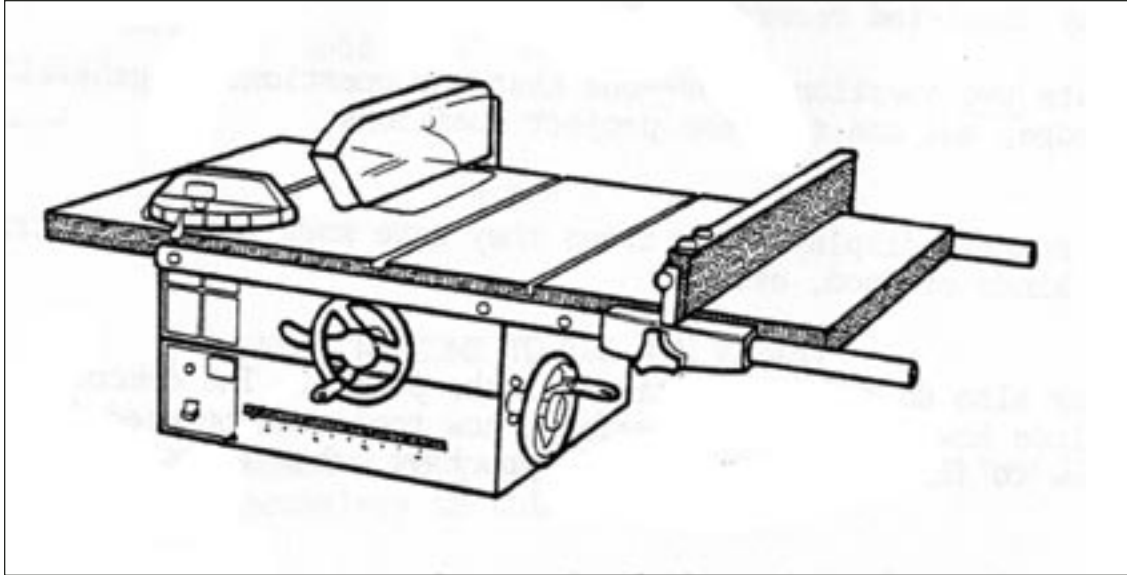

Using a Table Saw

1. Always wear goggles or a safety face shield. Use of a table saw in 4-H assumes adult supervision. Make sure sleeves are snug and not flapping.
2. If the table saw has a blade guard, use it.
3. Set the blade to a depth approximately 5 mm higher than the wood to be cut. Move the fence out of the way.
4. Set the mitre gauge to the cutting angle you want on the wood. Draw the gauge back so that the wood can be set against it without the wood hitting the blade.
5. Switch on the saw.
6. Hold the wood firmly against the mitre gauge with both hands. Slowly and steadily push the wood through the blade.
7. When the wood you are holding has passed the blade, slide it away from the blade and take it off the table.
8. Turn off the saw. Wait for the blade to stop before reaching for the cut part. It could touch the blade and get fired back at you.

Source: Saskatchewan 4-H

CLAMPING & GLUEING

Objectives

Members will be able to:

- identify at least three types of clamps
- demonstrate how to use those clamps
- show how to avoid clamping scars on a project
- determine the correct amount of pressure when clamping a glued joint
- name three types of glue used in woodworking, their respective properties and the best use of each

Prepare for the Meeting

- gather a selection of clamping materials, and items to be clamped
- provide examples of three types of glue, and examples of articles using those glues
- gather various size of dowels

At the Meeting

- compare and test various clamps on various sizes and shapes of projects
- practice preventing clamping marks
- how to remove clamping marks
- compare three types of glue and their use
- members determine types of glue to be used in their projects
- members practice using dowels

Epoxy glue

You have used white and yellow glues for other projects. White and yellow glues harden due to evaporation. When they harden, they shrink.

Epoxy glue does not shrink. Epoxy glue is a very strong glue that hardens due to chemical reaction. It is more expensive, so is used only when the project calls for it, such as joints where there are gaps. Epoxy glue fills up the gaps and then hardens to a very strong finish.

To use epoxy glue, it is necessary to mix two components together. Each glue will have its specific instructions on the container. Read them carefully and follow them completely.

When gluing wood, it is important that the wood be the same moisture content that it will be at time of use.

How to Glue

- select the appropriate glue
- prepare the project
- have the wood at the same approximate moisture level that it will be at time of use
- make sure all surfaces to be glued are clean and dry
- think through how you are going to clamp the project before applying the glue!
- have all the necessary equipment available
- apply glue to one or both surfaces (according to instructions)
- apply steady and uniform pressure with clamps
- wipe off excess glue
- allow glue to dry before removing clamps
- let the excess moisture at the joints (from the glue) evaporate before further machining. Let joints dry for several days.

Using Dowels

Dowels are used to fasten pieces of wood together and to strengthen joints. Dowels can be cut from dowel rods or purchased by the piece.

Dowel holes are cut with a drill press or with a hand drill, guided by a doweling jig.

What Diameter of Dowel? You should be able to insert the dry dowel into the dowel hole easily by hand. If it were too tight, the glue would be rubbed off as the dowel was inserted.

What Length of Dowel? Dowels are usually cut 1/4 inch shorter than the combined length of the two dowel holes. When you press the two pieces of wood together on the dowel, you do not want the dowel holding them apart!

What type of dowel? Choose between a plain dowel, a dowel with a longitudinal groove or a spiral grooved dowel. The grooves help the air trapped in the hole to escape and can help the glue to spread inside the hole, making for a stronger joint.

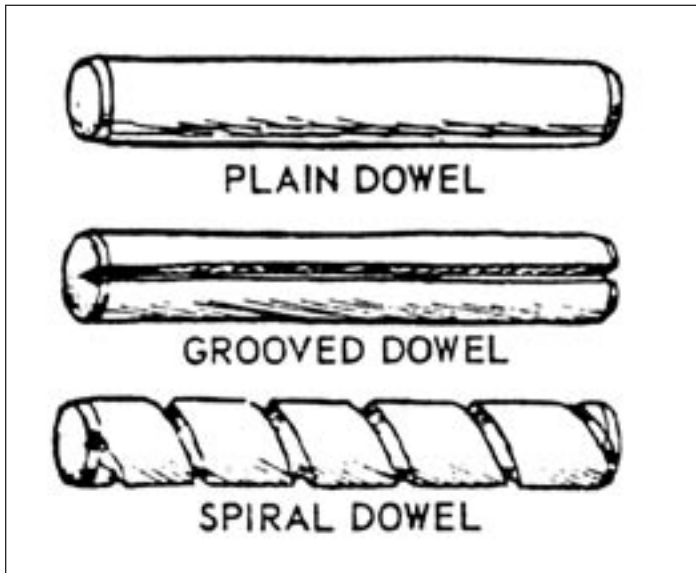

Do a dry run with the dowels in your project before applying glue!

Types of Clamps

C-Clamps

These are small c-shaped items which are used to hold two boards together for boring holes, gluing or making a saw guide. Tighten the screw to increase pressure. To prevent dents in the wood, put a piece of scrap wood between the clamp and the good wood.

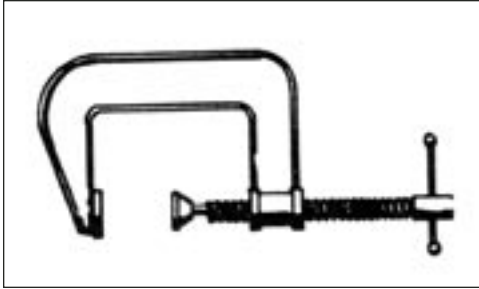

Handscrew Clamps

These clamps have two long parallel bolts which are adjusted separately. They are used for jobs that are too big for C-clamps. To adjust the pressure, screw the bolts in opposite directions.

Pipe Bar Clamps

These clamps come in a range of lengths. Adjust the clamp to fit the project by moving the adjustable stop back and forth along the bar. Increase pressure by turning the crank screw.

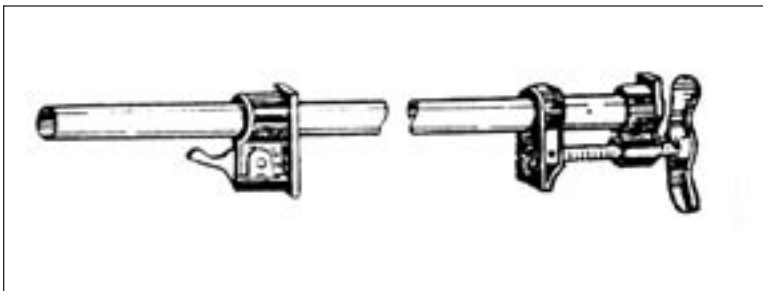

Adjustable Bar Clamp

This also called a cabinet clamp. It adjusts by turning the handle and can be used for the same purposes as the pipe bar clamp.

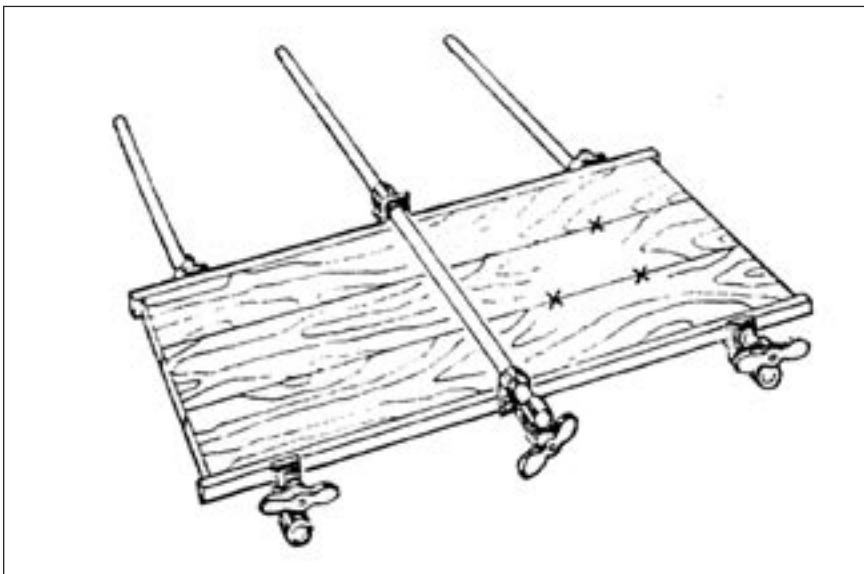

Clamping Tips

- keep clamps clean or you will be pressing grease and dirt into the wood fibres.
- protect wood surfaces by putting a piece of felt or scrap wood under the clamp
- use a piece of styrofoam against an irregular piece of wood when clamping. It will press into and hold the wood without marring.
- try pieces of inner tube as clamps for irregular pieces of wood

ADDITIONAL HAND TOOLS

Objectives

Members will be able to:

- identify block plane and jack plane and demonstrate their use
- demonstrate inspection and care of a plane
- assess need for blade adjustment
- accurately and safely set the blade in a plane
- use a plane to smooth wood
- explain the value of maintaining tools in good order

Planes

Woodworkers use planes to smooth wood surfaces to reduce or eliminate the need for sanding. Sounds good to me!

- Plane with the grain, not against it or you will raise splinters.
- Always set a plane down on its side. This protects the blade.
- Make or buy a fabric sock for storing your plane.

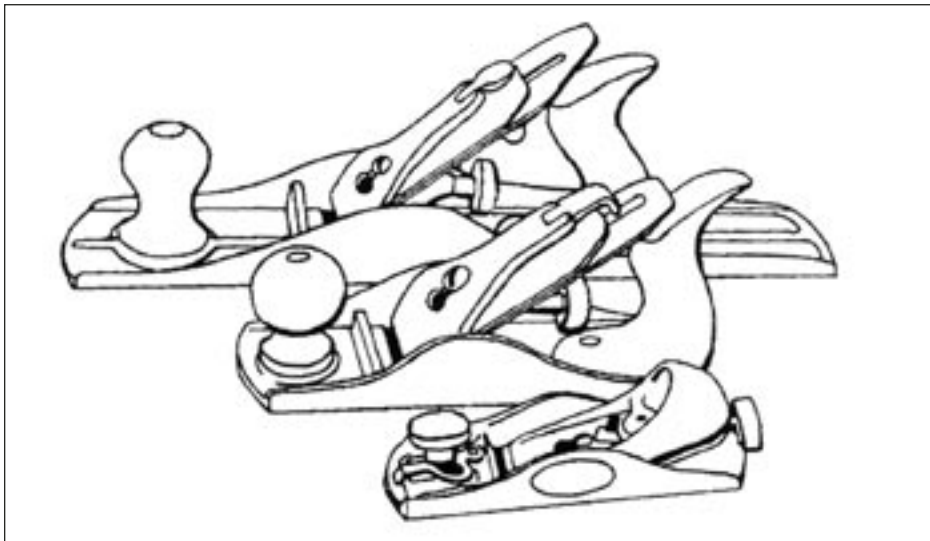

There are many kinds of planes available. Here are the most commonly used ones.

Block Planes

The smallest and most practical plane for young woodworkers, the block plane is about 12 cm long. It is small enough to be carried in a tool box. It works well to finish work. It has a low blade angle and is often used for fine work or cutting across end grain.

It is important that planes be in proper adjustment, or they do not do a proper job. Turn the plane over and check along the bottom. The blade should appear through the gap evenly, about the thickness of a sheet of paper.

To push the plane iron out (to get more blade exposed) turn the adjusting knob clockwise. To pull the iron in, turn the knob to the left until the blade is in the correct position. Then turn it clockwise until it starts to push the plane out. The plane iron will stay in the right place when the plane is used.

To adjust for an even blade, loosen the lever cap screw. Turn the plane over and look at it. Press the plane iron to the right or left until it is even. Then tighten the lever cap screw.

Test the plane on a piece of scrap wood, not your project.

Smooth Plane

This is also a short plane, in sizes from 12 to 25 cm long. It cuts extremely smooth surfaces and stays adjusted. The smooth plane can also be used for rough planing, planing end grain, chamfers and edge shaping.

Jack Plane

This is a medium sized plane, from 30 to 75cm long, which can be used for just about any job! Because it has a longer bottom, it does less riding up and down on uneven surfaces and quickly cuts off the high spots.

Fore Plane and Jointer Plane

These planes do a good job on cutting an edge or surface perfectly straight. Fore planes are usually 45 cm long and jointer planes are usually 45 cm to 60cm long. Their long lengths allow them to ride over bumps and produce a smoothly cut surface.

SHARPENING TOOLS

Do this with adult supervision.

Whetting

Whet your chisels and plane irons on an oil stone to keep a very sharp cutting edge.

Apply oil to the stone surface to keep it moist. The oil prevents particles of steel from clogging the pores of the stone. Wipe the stone before putting it away.

Hold the chisel or plane iron on the fine grit oil stone with the bevel flat on the surface. Raise the handle slightly (5 degrees or less) so you whet only the forward part of the bevel.

Move the chisel or plane in a circular pattern back and forth lengthwise on the stone several times. Working in this way wears the stone evenly so it will last you all your life.

After you have sharpened the bevel edge, turn the blade over to remove the little bits that have appeared on the other side. Lay the blade flat on the stone. Move it back and forth a few times to remove those little bits.

Inspect the blade edge. Is it completely and evenly sharpened? Are there still some nicks or unsharpened spots? It may be necessary to repeat the whetting process until you have done a complete job.

Test your blade on a piece of wood (not your project!).

Plane marks show less if the corners of the plane iron are slightly rounded.

Round off the corners by slight honing on the whet stone.

When is it time to grind? When you notice the cutting edge is nicked or it is getting harder and harder to use the tool, it is time to grind.

Use a grind stone or an emery stone for this job. Your leader or another adult will demonstrate this.

Wear eye protection! Dip the blade in water frequently so it does not over heat. You may want to hold the blade in a clamp to hold it steady while grinding.

The plane iron or chisel should be ground to a 25 or 30 degree angle. This provides the right combination of sharpness and strength.

After grinding finish by whetting on the oil stone for a very sharp cutting edge.

WOODWORKING TIPS

- If you store your tools on a pegboard, paint the shape of the tool on the board, to help tools make their way back to the right spot!
- Magnetic strips on the workbench or on the wall nearby hold small metal tools in sight.
- Fight scratches and rust on hand tools. Store them in a drawer on a piece of carpet which has been sprayed with light machine oil.
- Help your tape measure slide smoothly! Rub it with a bit of paste wax.
- When buying a tool with a wooden handle, examine the direction of the grain of the wood. Wood grain that runs parallel to the tool head is strongest.
- A bit of beeswax or paraffin on the tip of a nail will aid in driving a nail into hardwood.
- Don't want to hit your thumb when starting a nail? Hold the nail with a pair of pliers, or else push it through a piece of cardboard or stiff paper!
- Protect the teeth on your handsaw. Slide it into a slit piece of old garden hose or a piece of styrofoam.
- Store and transport your wood chisels with their points in an old soft ball. Tennis balls work well for this.
- Does your saw blade get stuck in the kerf when sawing long pieces of wood? Prevent this by sticking a small wooden shim into the kerf after you have started the cut.
- Only use one measuring tape for a project. Sometimes the end hooks vary as much as 1/16 inch. If you must use more than one measuring tape, check them to ensure they give the same measurement.
- For precise measurements with a measuring tape, start measuring at the one cm. or one inch mark on the tape. (Sometimes the end hook has a bit of play in it.)
- To check for square in a project, measure the diagonals of the piece. They should measure exactly the same.
- Making many pieces of the same item? Use only one piece as the pattern.
- You can copy a pattern using a photocopy and an iron! Copy the picture you want. Turn the page, print down, onto the wood. Tape it so it will not shift. Heat it with an iron. Check occasionally to make sure the pattern is clear in all areas. If the pattern has words on it, first print it onto tissue paper, then turn that copy over and copy it. You will produce a copy that has the words backwards on it.
- Use old inner tubes as clamps. They will apply gentle but firm pressure onto odd shaped projects.
- Are your C clamps leaving marks on projects? Pad the clamping surfaces with felt, chair leg protectors, the caps from film canisters or small pieces of wood.
- Store glue bottles upside down, with the caps on securely! Store in a can or else make a simple holder similar to a toothbrush holder.
- Save those old toothbrushes! They work well to clean out dust or to apply stain in small areas.
- A little too heavy with the hammer? Made a few too many dents? Lift the dent by ironing a moist cloth over the dent. (Wood cells swell with the addition of water.)
- Hands all splattered with oil-based paint or stain? Soften the paint with salad oil! Then, wash with warm soap and water.
- To prevent dents from those last hammer taps, put an old tennis ball over the head of the hammer.
- Use clothes pins as mini clamps for tiny pieces of wood.
- If you lose the lid from your glue bottle, or the original one does not work well, try a mariette (the electrical wire nuts you use to twist two or more electrical wires together). The thread should hold on snugly.
- Never saw freehand. Take the time to draw a straight line!
- Put a piece of scrap wood under your project when you are drilling holes in it. This will prevent you drilling holes into the work surface.
- Always saw on the waste side of the marking line.
- Clean as you go.

- Do you plan to stain your project? Stain it before filling the nail holes, to prevent residue blemishes on the wood.
- Stain soaks deeply into end grain and makes it darker than face grain. To better match the stain, sand the end grain with a higher grit sandpaper than the face grain.
- Prevent rounding of edges by a power sander by putting another board the same thickness up against the board you are sanding. The sander will ride straight over the edge, rather than around it.
- Try styrofoam to clamp irregular shapes. The styrofoam will conform to the shape of the piece and hug it snugly without scratching.
- Hammer head slipping? Rough up the surface with a coarse emery cloth, a file or an abrasive wheel.
- Do you keep dropping screws when starting them? Try:
 1. *Chewing gum on the head (the screw's head, not yours!)*
 2. *Rubber cement on the head.*
 3. *A short piece of rubber hose on the tip of the screwdriver that is slightly bigger than the head of the screw.*
- Save some sawdust from your project to make perfectly matched wood putty. Mix the dust with white glue.
- Do your safety goggles fog up? After cleaning and drying them, put one drop of dish detergent on them and wipe dry.
- When using tools, focus on the job. If you need to talk to someone, stop work first.
- Avoid startling someone who is using tools or power equipment. Approach from the front, slowly, if possible. (Kind of like approaching a horse!)
- Never force a machine.
- Ask your leader to show you how to check to see if a machine or tool is properly grounded.
- To prevent bubbles, do not shake topcoats. Stir them gently.
- Make your own tack cloths! Moisten cheesecloth in mineral spirits. Add a teaspoon of any topcoat material (e.g. varnish) to the cheesecloth and knead it until the topcoat material is absorbed evenly. Store in a closed glass jar.
- When planing hard wood, follow the grain.
- Practice new skills on scrap wood first!
- A surface that you are going to glue should be clean and free of dust, but not sanded. Wood glues best soon after it is cut.

THINGS TO MAKE

1. Tray
2. Shadow Box
3. Chess Set
4. Paddle full size or for display only
5. Picture or Mirror Frame
6. Date Cubes
7. Set of Wooden Letters
8. Turtle Box

Tray

Make this as a practical item or decorate it to add colour to your home! This tray features rabbeted corners and a dadoed bottom for strength and appearance. Select a washable finish. The dimensions are for a standard tray. Adjust them for your needs. Optional hand holes can be cut to size.

The next time you make this tray, you could try another type of joint.

A simpler version of this tray can be made with butt joints, gluing and using fine screws to secure.

Cut List

- 1 1/4" x 20" by 13" of plywood (tray bottom)
- 2 2" x 2" x 20" sides (Wood of your choice)
- 2 2" x 3" x 12" ends (Wood of your choice)

Instructions

As with all projects, it is suggested that you sketch or make a cardboard model of this project first, before making it in wood.

1. Measure, mark and cut the pieces of wood.
2. Test assemble the pieces to check for fit.
3. Insert a 1/4" dado blade in the table saw. Set it to cut a groove 1/4" deep. Test a scrap of the wood you are using for the tray bottom in this groove. When this fits smoothly, dado the ends and sides of the tray bottom.
4. Test assemble the tray.
5. If you want to have hand holes in the ends of the tray, sketch and cut them now. Sand them smoothly.
6. Sand all the parts of the tray.
7. Glue, assemble and clamp.
8. Finish as desired.
9. Take a picture for your record book!

Shadow Box

Use this to display pictures or collections of small items. Use the type of corner joint you prefer. Or make several shadow boxes, each with a different style of joint.

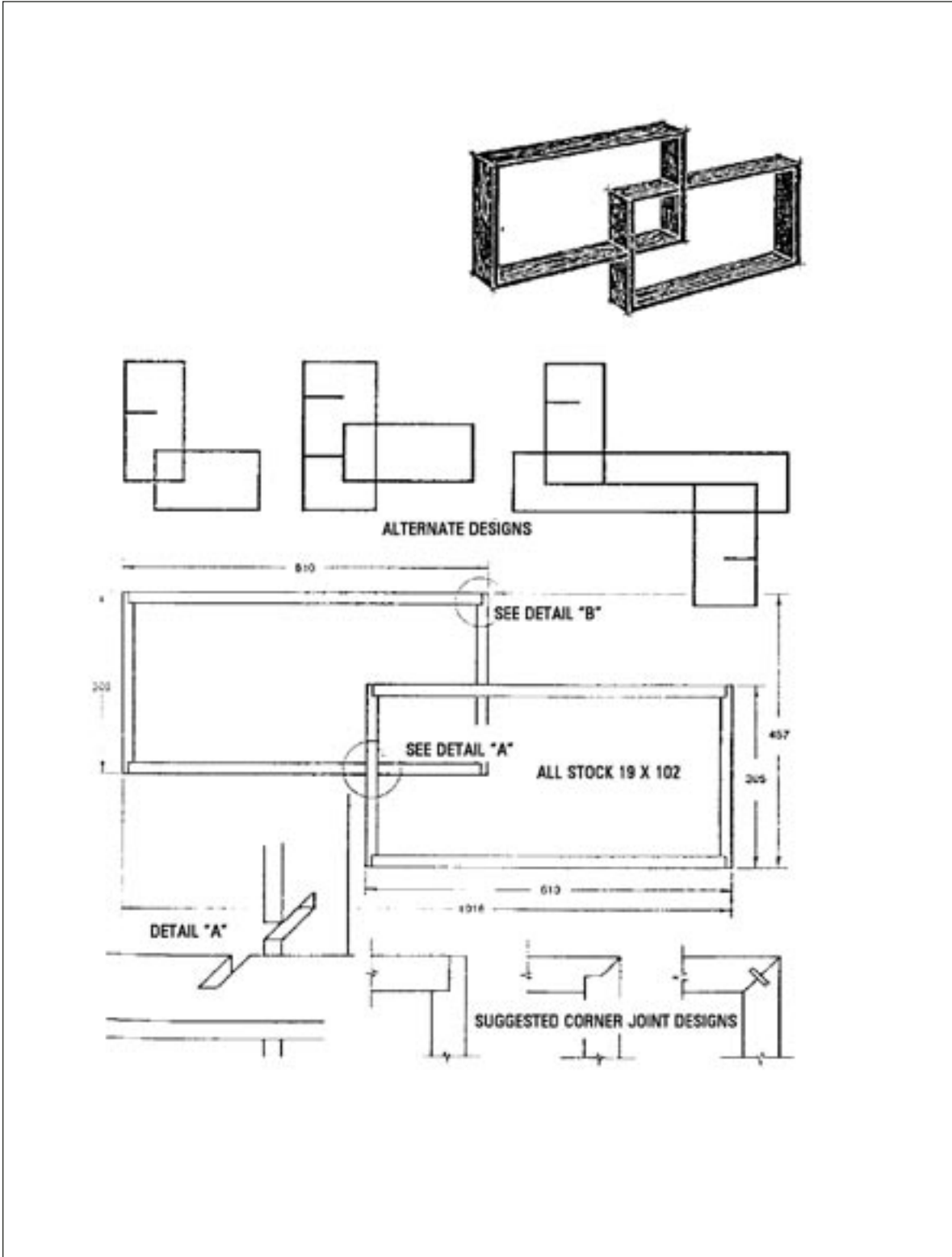

Chess Set

Make one for a special gift or one for yourself! A challenging project.

The designs for the chess pieces can easily be modified or replaced with styles you prefer. The traditional sizes for the pieces descend in this order: king, queen, bishop, knight, rook, pawn.



If you have only one colour of wood, stain half of it to provide the colour contrast needed for the two armies of pieces.

Materials for the Chess Figures

- green felt
- Hardwood
- Dark 950mm x 25mm x 25mm
- Light 950mm x 25mm x 25mm

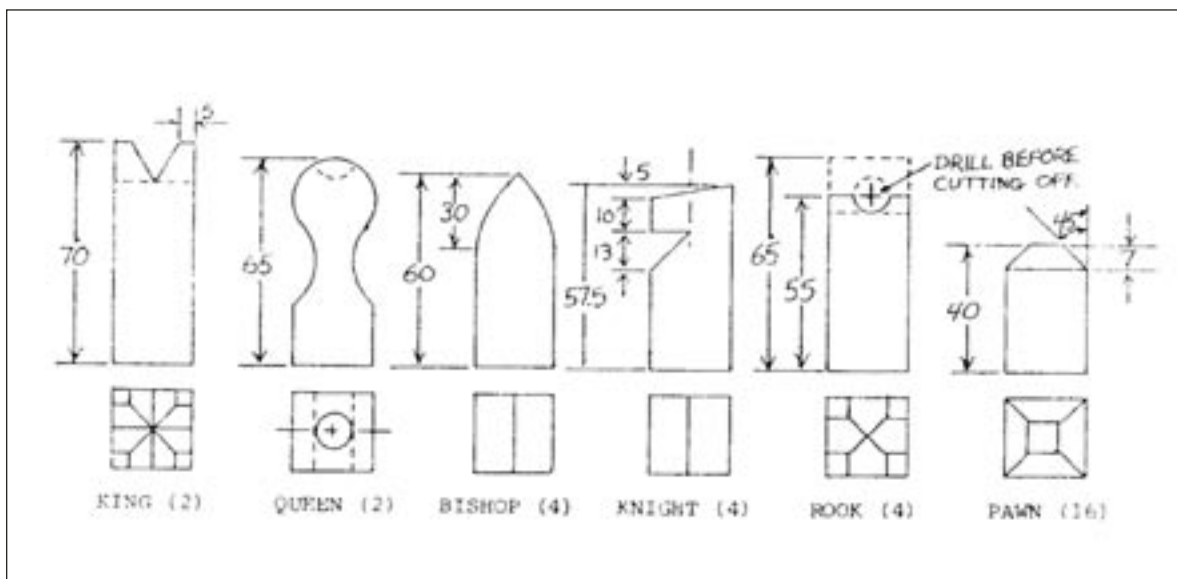

Tools

- pencil
- sanding disc
- ruler
- pencil
- try square
- marking guage
- tenon saw
- file
- chisel

Instructions

1. Mark and cut out the 16 pieces from the light wood and from the dark wood.
2. Use a sanding disc to trim the pieces to the exact length.
3. Mark out the desired design on the pieces, using a ruler, pencil, try square and marking gauge.
4. Cut with a tenon saw.
5. Shape and tidy up the cuts with a file and firmer chisel.
6. Use a sanding disc and belt sander where possible to assist in the shaping.
7. Do final sanding with glasspaper.
8. Varnish the pieces.
9. Glue green felt to the bottom of the pieces, so they do not scratch the board.

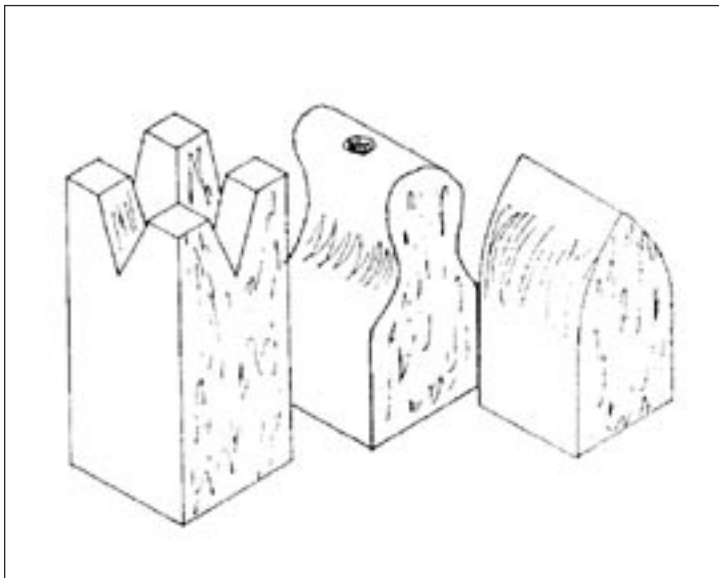

The Chess Board

Materials

- 4 strips of white wood for the board 15mm x 35mm x 350mm
- 4 strips of dark wood for the board 15mm x 35mm x 350mm
- 4 strips for frame 10mm x 25mm x 350mm

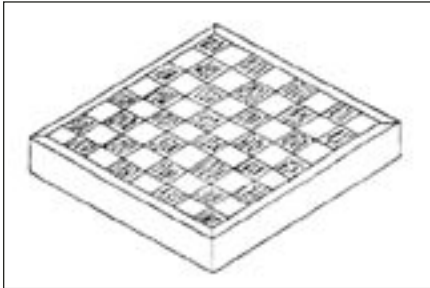

Tools

- measuring tools
- plane
- marking gauge
- table saw
- sandpapers
- nails
- nail set
- paste wax

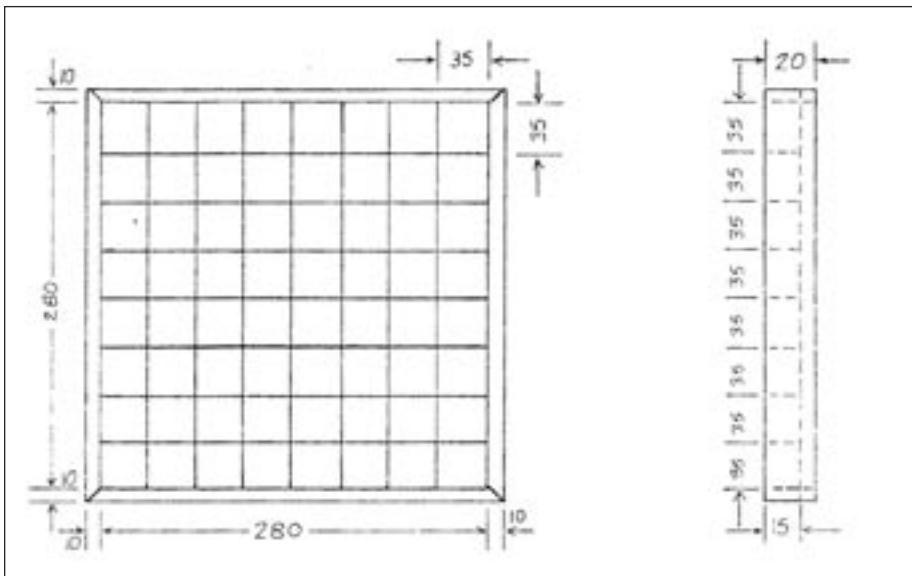

Instructions

Phase One

1. The strips are longer than the finished board, to allow for error and sanding
2. Lay the strips for the board side by side, alternating dark and light woods. Watch the direction of grains, so the pattern will be most pleasing.

3. Glue the inside edges of each strip and clamp tightly, using pipe clamps. Make sure all pieces remain level and even at one end. If you notice them buckling, unclamp, flatten them down, then reclamp. Do not rush this stage!
4. Allow to dry for 24 hours.

Phase Two

1. Recut the board into 35mm strips, across the coloured strips of glued wood.
2. Lay the strips out in a chess board pattern. Match the corners perfectly.
3. Glue and clamp.
4. Allow to dry for 24 hours.

Phase Three

1. Plane one side flat and smooth. Do not remove any more wood than is necessary.
2. Mark the board to thickness using a marking gauge.
3. Plane the board to thickness.
4. Plane the edges smooth and 90 degrees to the best side.
5. Measure board to length (check the numbers of squares required!).
6. After triple checking, cut off the extra length of board.
7. Sand all sides and edges flat and smooth using increasingly finer grades of sandpaper.
8. Measure and cut your frame strips.
9. Fit frame strips to the board using mitred corners.
10. Nail the frame to the board. Set and fill the nail holes.
11. Sand all surfaces.
12. Varnish. Let dry 24 hours.
13. Sand with 400 wet/dry sandpaper.
14. Apply second coat of varnish.
15. Sand lightly with 400 wet/dry sandpaper.
16. Apply two coats of paste wax allow 20 minutes between coats. Polish.
17. Invite someone over for a game of chess!

Paddle

You can make this project from hardwood or softwood. With hardwoods, you will be able to achieve a thinner blade. Woods that work well for a paddle include spruce, cherry, maple, pine, butternut and ash. Some people like to use a combination of woods in a paddle, especially if it is to be displayed.

The correct size for a personal paddle? If you can rest your chin on it while standing, it is the correct length for you. The instructions given are for a generic paddle, made of fir. This paddle is good for both lake and river use. The Lee Valley Tools web site gives instructions on making a marking jig which helps in marking the shape you would like in your paddle shaft. Visit www.leevalley.com.

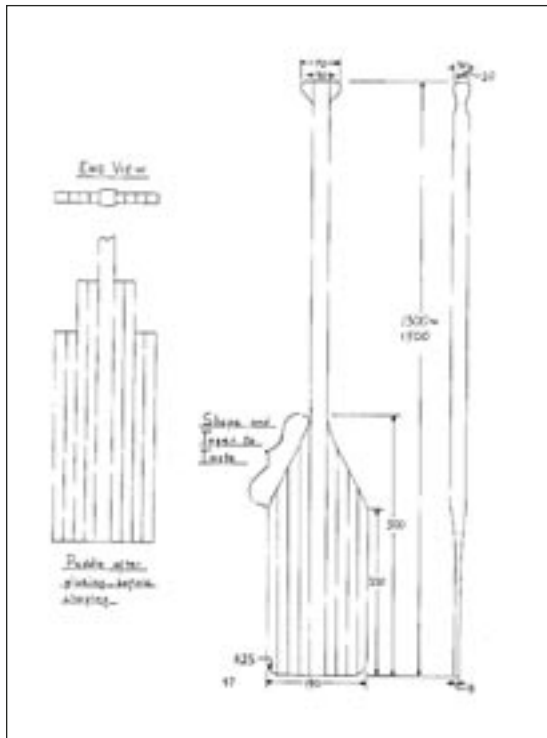

Materials

- 1 30mm x 30mm x 1500mm
- 4 20mm x 20mm x 550mm
- 4 20mm x 15mm x 450mm
- 2 30mm x 30mm x 100mm
- waterproof glue (titebond II)
- sandpaper
- marine varnish or urethane

Tools

- table saw
- jigsaw
- rasps
- clamps
- planes

Instructions

1. Make sure that the main shaft piece (the longest one) is straight, true and without flaws.
2. Glue 2 – 20mm x 20mm x 550mm pieces directly onto each side of the main shaft with ends flush. Clamp well and let dry.
3. Glue 2 – 15mm x 20mm x 450mm to the sides of the pieces you glued on in step 2. Clamp and let dry.
4. Glue the 2 – 30mm x 30mm x 100mm pieces to opposite sides of the handle end of the paddle. Clamp and let dry.
5. Pencil the outline of the blade shape on the paddle. Pencil the desired handle shape on the handle. If you already have a paddle you like, you could use it as a pattern.
6. Bandsaw or jigsaw the shape.
7. Using rasps and planes, shape and taper the blade to about 8mm on the edges and tip. The middle of the blade should remain a bit thicker, about 12mm (for strength). The blade should thicken a bit as it reaches the shaft.
8. Round the shaft until it feels comfortable in your hands.
9. Shape and taper the handle so it comfortably fits your hand. A bad fit to your hand can cause blisters. Blisters are not fun on a canoe trip.
10. Sand smooth. Remove dust. If you wish, you can put some kind of identification mark somewhere on your paddle at this time (initials, phone number etc. It's optional, but a good idea.)
11. Apply three coats of marine varnish or urethane.
12. Ask someone to take a picture of you with your new paddle. Congratulations! Long may your paddle sing.

Alternative

You may also paint the paddle with exterior grade paint. You can also paint or burn a design into the paddle, then varnish over it for protection.



Picture or Mirror Frame

You can make this to any dimensions, of course. Varnish the frame, if you wish to show off the grain. Paint it, if you want to emphasize what the frame will hold. Or leave it unfinished, if you are using a material such as old barn board! The choice is yours.

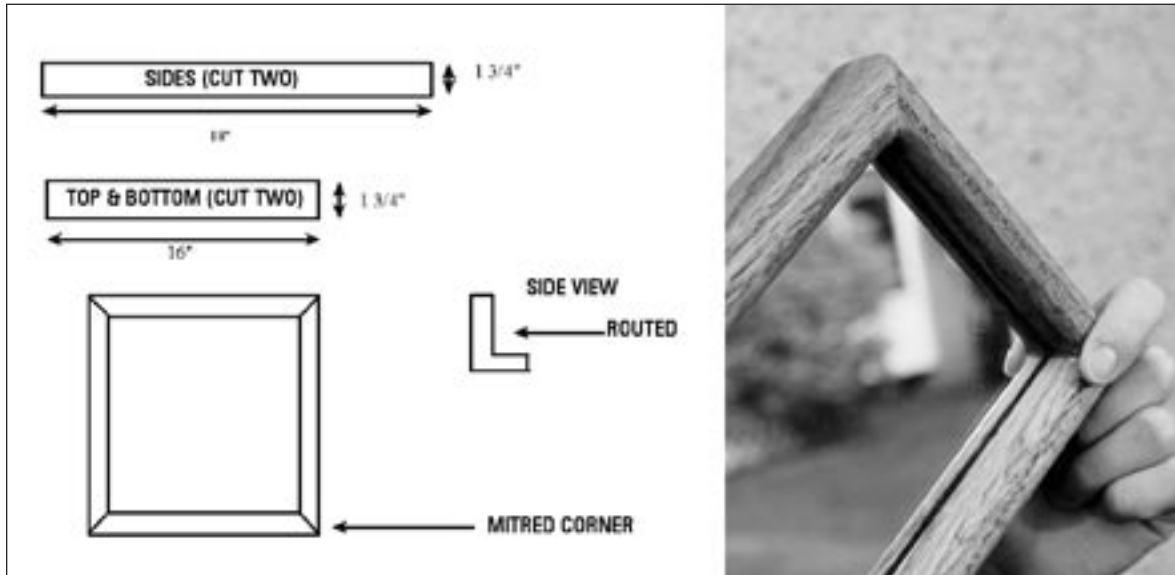

Materials

- wood of your choice
- glue
- thin panel pins (optional)
- glass or mirror cut to fit (have this cut after you have made the frame!)
- matting for picture (optional, but recommended)
- small screws and wire for hanging
- small scraps of felt

Tools

- mitre box and saw
- router
- sander
- saw

Cut List

- 2 1 3/4" x 1 3/4" x 18" (sides)
- 2 1 3/4" x 1 3/4" x 16" (top and bottom)
- 1 piece of thin board to fit within the finished back (measure and cut to fit finished frame)

Instructions to make a 18" by 16" frame.

1. Cut wood, using a mitre saw and box. Cut at a 45 degree angle. Take great care to avoid splinters.
2. Test assemble the pieces, to make sure everything will fit together snugly.

3. On the back side of each piece, rout out a groove on the inside of each piece. This will form a ledge that the picture or mirror will rest on.

If you are routing hard wood, it may take more than one pass to make the depth of ledge you want. Do not force your router.

4. Glue and clamp the four pieces together. Lay on a flat surface. Let dry overnight. It might be a good idea to put a clean piece of paper or cardboard over top, with a bit of weight, to hold things flat as they dry.
5. If you want extra reinforcement, use very thin panel pins to nail the pieces together.
6. Have the glass or mirror cut now to fit the finished product. Insert the glass or mirror into the frame. Secure it with fine panel pins.



7. Attach picture wire frame between small screws.
8. Glue small pieces of felt to bottom corner of frame so it will not mar the wall.

Tip: To avoid tilting pictures, hang frames from two, not single hooks on the wall.

Date Cubes

This project requires you to make two identical cubes from hardwood. With only two cubes you will be able to display all the days of the month. This project calls for a steady hand with a router. You can make the cubes with scraps of hardwood.

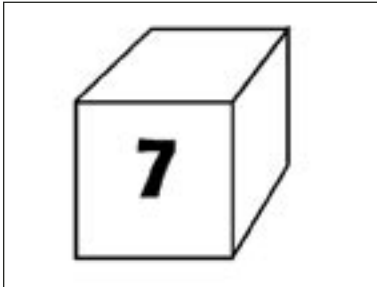

Materials

- enough hardwood to make two cubes the size that you want
- glue

Tools

- table saw
- square
- measuring tools
- hobby knife or carbon paper to transfer patterns
- pencil
- disc sander
- sandpaper
- clamps
- router
- if starting with rough lumber, you will need access to a joiner or a planer
- patterns for numbers

Instructions

1. First, practice on scrap wood making numbers using the router tip you plan to use for the numbers. This step will help you decide how big you should make your cubes. Anything smaller than two inches would be very difficult to work with, or to read.
2. If you are starting with rough lumber, smooth it so that it will glue together perfectly.
3. Measure, cut, glue and clamp your two cubes of hardwood. Take care to line up the grain in a way that you find pleasing.
4. Use the disc sander to smooth all surfaces. Make sure that all sides are square to each other and have the same dimension.
5. Print a style of number that you like (the simpler the better for a first try) using a computer. Trace or cut the pattern into the wood. The cut outline of the numbers will guide you when you are routing.
6. On one cube you will rout these numbers : 0, 1, 2, 3, 4, 5. On the other cube, make these numbers: 0, 1, 2, 6, 7, 8. (One "6" will serve also as a "9".)
7. Sand the routed cubes, using increasingly finer sandpapers. Finish with your preferred finishes.
8. Take a picture for your record book! Congratulations!

The numbers on the cubes can also be painted or burned in using wood burning tools.

Wooden Letters

This is a good way to practice using a band saw, jigsaw or scroll saw. You could make a set of letters as a gift for a child, for a local school or Sunday School. You could also make separate letters that spell out a name or messages, which could be used at home or on a shelf at school or at a Seniors' Centre. E.g. Happy Birthday! Joy! Congratulations! Welcome! Etc.



Materials

- plywood or hardwood (how thick will the wood need to be, so that the letters will stand up easily?)
- paint or stain – if these are to be used by a young child, select a child safe finish
- patterns for letters

Tools

- band saw or jig saw or scroll saw
- sandpaper
- paintbrush
- ruler

Instructions

1. Mark the letters you are going to cut out on the wood, using either a pattern or by drawing freehand.
2. Cut out the letters. With letters that have an interior opening drill a hole first, then use an appropriate saw.
3. Sand carefully, working to avoid splintering the wood.
4. Finish, using a child-friendly paint.
5. Take a picture for your record book or e-mail it to us! Congratulations!

Business Card Holder

Makes a great gift. Also a great item for bazaars or fundraisers! Very simple, useful item which requires careful use of band saw, orbital sander and router. It uses up those scraps of hardwood!



This would be a very nice thank you gift for sponsors, guest speakers or judges!

Make one long holder, rout the channel out, then cut to desired width. If you try to make just one, it is too tricky to rout out the channel.

Materials

- 1 scrap of hardwood, 1" thick
- finishing supplies
- sandpaper

Tools

- Band saw
- Router

Instructions

1. Cut a strip of hardwood about 2" wide and slightly longer than three business cards are wide.
2. Secure the wood. Using a 1/2" bit, cut a 2" deep channel in the top. The business cards will sit in this channel.
3. Sand and finish.

Turtle Box

This is a clever container made of a 2" x 4"!



Materials

- 1 2 x 4 x 24"
- glue
- sandpaper
- varnish or other finish of your choice

Tools

- joiner or planer
- clamps
- band or scroll saw
- pencil
- disc sander

Instructions

1. Run the 2 x 4 through the joiner or planer to get completely smooth surfaces.
2. Cut the 2x4 into three equal lengths (approximately 8" each).
3. Glue one piece of 2 x 4 on top of another. Clamp and let dry.
4. Glue the third piece of 2 x 4 to the top of the other two. Clamp and let dry.
5. Draw the pattern of the turtle on the top of the glued wood (on the side with no seams).
6. Use a band saw or scroll saw to cut out the turtle.
7. Cut a 1/4" layer of turtle off both sides. You will have two thin turtle shapes and one thick one.
8. Trace the drawer pattern on the thick turtle.
9. Use the band saw to cut out the drawer.
10. Use the band saw to cut a 1/4" layer off both sides of the drawer. You will end up with two thin drawer pieces and one thick one.

11. Trace the drawer cavity on the thick piece of drawer.
12. Use the band saw to cut out the drawer cavity out of the thick piece of drawer.
13. Glue the thin drawer pieces to the thick drawer piece, to make a complete drawer! Test to make sure it will go into the turtle. Clamp and let dry.
14. Glue the thin turtle pieces to the thick turtle pieces to make a turtle. Clamp and let dry.
15. Sand to remove all traces of glue and to smooth the surfaces.
16. Stain and varnish the way you would like.
17. Take a picture for your record book!

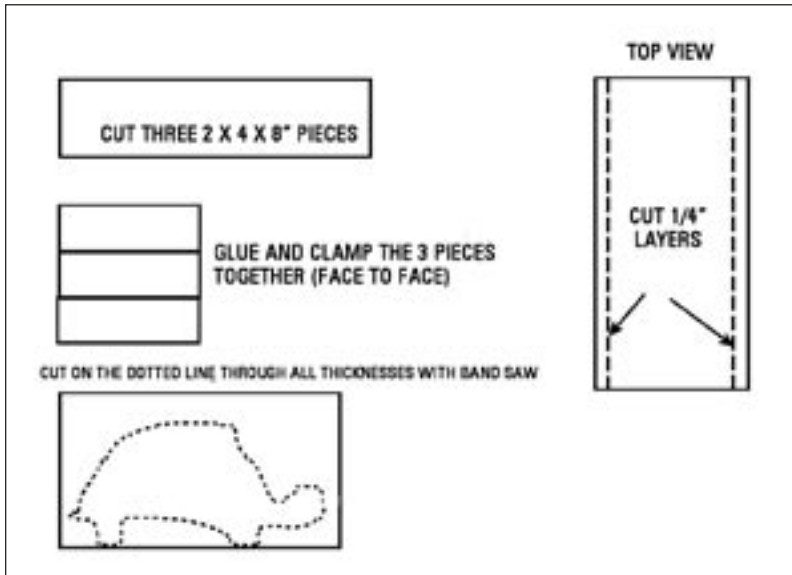

I CAN: LEADER'S SIGNATURES

Leader Signature

Safety

- Meet all safety objective of levels one and two _____
- Identify and deal appropriately with shop hazards - physical, mechanical, chemical, electrical and human _____
- Encourage safe behaviour in other people _____
- Show leadership by working and playing safely _____
- Teach safe procedures to other members _____
- Select personal protective devices according to task at hand _____
- Determine if safety shields are in place by visual inspection _____
- Locate shut offs for power tools _____
- Operate shut offs _____

The Forestry Industry

- Identify forestry as one of Alberta's major industries and employers _____
- Trace the route of wood products from wood lot to consumer _____
- Name at least five careers linked to forestry and the preparation for that career _____
- List sources of information on the forestry industry _____

Drafting, Drawing & Dimensioning

- Produce, read and interpret isometric and orthographic drawings _____
- Translate drawings into projects _____
- Identify/determine degree of difficulty of a project from a drawing _____
- Plan order of work from a drawing _____
- Plan layout of pattern on wood, to get best use of wood _____
- Label drawing accurately and clearly according to standard woodworking procedures _____
- Take accurate measurements _____

Joinery

- Identify at least three different joints and explain how they are made _____
- Identify tools used for specific joints _____
- Construct a project using a new type of joint _____
- Select jointing techniques according to strength, appearance _____
- Glue and clamp a joint for maximum strength and best appearance _____

Super Power Tools

- May include the following: Router, Band Saw, Radial Arm Saw, Drill Press, Stationery Belt Sander, Bench Grinder, Table Saw. _____
- Identify tools accurately _____
- Explain purpose of each tool _____
- Explain and demonstrate the use of each tool _____
- Explain safety precautions for each tool _____
- Compare various models _____
- Demonstrate safe use of tools _____
- Ask for help if unsure _____
- Ask another member to stop if I see unsafe practices or hazards. _____

Gluing & Clamping

- Identify at least three types of clamps _____
- Demonstrate how to use those clamps _____
- Show how to avoid clamping scars on a project _____
- Determine the correct amount of pressure when clamping a glued joint _____
- Name three types of glue used in woodworking, their respective properties and the best use of each _____

Additional Hand Tools

- Identify block plane and jack plane and demonstrate their use
- Demonstrate inspection and care of a plane
- Assess need for blade adjustment
- Accurately and safely set the blade in a plane
- Use a plane to smooth wood
- Explain the value of maintaining tools in good order

Sharpening Tools

- Determine when a tool needs to be sharpened
- Name the equipment and supplies to be used in sharpening
- Observe safe procedures when sharpening tools
- Sharpen chisels and plane irons
- Test for the quality of a sharpening job
- Explain how to use and store tools to prevent damage and excessive wear
- Explain dressing of a grindstone - what, why, how and when
