

FARM MACHINERY

Tractors

Guide for Leaders and Youth Leaders

Ontario 4-H Council

4-H 600 00 LE

*Ontario Ministry of Agriculture,
Food and Rural Affairs*

The Ontario 4-H Program provides opportunities
for the personal development of youth.
<http://www.4-hontario.ca>

THE 4-H PLEDGE

"I pledge:
My Head to clearer thinking
My Heart to greater loyalty
My Hands to larger service
My Health to better living
For my club, my community and my country."

TABLE OF CONTENTS

	PAGE
WELCOME TO 4-H.....	1
WHAT ARE MY RESPONSIBILITIES AS A 4-H CLUB LEADER?.....	1
4-H CLUB PROGRAM PLANNING	2
WHAT IS AN ACHIEVEMENT PROGRAM?.....	2
MEETING ONE: Tractor History and Development.....	7
MEETING TWO: Preparing to Drive - Safely.....	17
MEETING THREE: Tractor Systems.....	21
MEETING FOUR: Diesel Engines.....	25
MEETING FIVE: Traction	29
MEETING SIX: Maintenance and Service	31

This project was originally prepared by
Allen Hills, Ashton and updated in 1999 for the Ontario 4-H Council.
Special thanks to the original advisory committee:
Glenn Barkey, 4-H Member, Blackstock, Jack Price, 4-H Leader, Harrowsmith,
and OMAFRA staff.

©Copyright Ontario 4-H Council and Queen's Printer For Ontario, 1999.

The Ontario 4-H Council and the Ontario Ministry of Agriculture, Food and Rural
Affairs jointly funded this project.

BE A "GREEN" 4-H CLUB

The 4-H program uses a lot of paper. Please help us to reduce our costs, and save a few trees, by remembering these tips.

- Only 4-H members (10-21) and screened volunteers should receive 4-H resources.
- If your club plans to do this project again, keep the resource materials so you don't need to reorder.
- If your club has extra resources, please return them promptly to the Ontario Ministry of Agriculture, Food and Rural Affairs so someone else can use them.

WELCOME TO 4-H

It has often been said that, "Volunteer 4-H club leaders are a blend of friend, teacher and parent." That's a big order to fill! But you will discover that you have many talents as a 4-H club leader. Having an interest in young people and their development and being willing to take up the challenge of 4-H leadership is the first step to success.

This project focuses on farm machinery and is recommended for senior members. However, the development of members as individuals is your real goal. You will get to know the club members and where their interests lie very well. Use this knowledge, your own expertise and imagination to help members plan a fun, interesting and challenging club program. Enjoy being a 4-H club leader!

WHAT ARE MY RESPONSIBILITIES AS A 4-H CLUB LEADER?

Before your project begins:

1. Familiarize yourself with current provincial and local 4-H policies;
2. Attend a leader training session (if scheduled);
3. Advertise the project and organize a club with a minimum of six eligible members and one volunteer leader per club except in cases deemed to be unique and approved by the local 4-H Association; and
4. Review available resources and begin planning the club program.

During the project:

1. Attend each meeting and the Achievement Program;
2. Assist members in planning and presenting the club program;
3. Provide a FUN, learning atmosphere;
4. Ensure the club membership list is completed and forwarded to the Ontario Ministry of Agriculture, Food and Rural Affairs before the second meeting;
5. Order awards and project and name plates once membership list is completed.
6. Help each member to set and achieve goals for personal development;
7. Encourage members to work together as a group;
8. Provide guidance in choosing and completing an Achievement Program; and
9. Evaluate the club program. Share the evaluation with the 4-H Association and the Ontario 4-H Council.

4-H CLUB PROGRAM PLANNING

A successful 4-H club doesn't just happen! Careful planning is necessary and very important. As a 4-H leader, you have a responsibility to do the best job you can in providing a fun, learning experience for the 4-H members. Planning will make this a reality.

The 4-H Volunteers' Handbook has lots of valuable information to help you and your members plan a successful club program. Refer to "The 4-H Meeting" section of your handbook for tips on planning successful meetings, effective communication, games, judging and special events. The chart on page 3 can be used to record your plans.

WHAT IS AN ACHIEVEMENT PROGRAM?

- An opportunity for members to share with others the knowledge and skills they have gained during this 4-H project.
- Involves each member in some way.
- Informs the public about the purpose and goals of the 4-H program.

Achievement Program ideas specific to this project are suggested below. Your club may wish to choose one idea or combine a few. Involve club members in selecting a suitable idea and making the necessary preparations.

The Achievement Program can have many forms:

- held as a full day event
- with a fall fair
- with a plowing match
- as a self contained event
- with a 4-H Safety club
- tour of the Ontario Agricultural Museum or machinery manufacturing plant
- held as an evening event with the same time frame as a normal meeting.

The format you use will dictate the make up of the program, but it could include all or some of the following activities.

- have 2 or more tractors available, have members complete a pre-operational check; and then have them give their reasons for one tractor being a safer tractor than the others.
- have members select a tractor or piece of equipment they are familiar with and give an oral report on its safety features, proper maintenance, safe operating procedures, etc. This could be held at a dealership (for large clubs) or by travelling to each member's farm (for small clubs).

4-H CLUB PROGRAM PLANNING CHART

MEETING OR EVENT	DATE	TOPIC ACTIVITY OR TASK	PEOPLE WHO COULD HELP	PRESENTATION IDEAS TO CONSIDER

- a simplified version of the farm safety rodeo can be used as a format for members to demonstrate the safe handling of a tractor. Emphasis should be on proper starting, operating, and stopping as covered in the project rather than intricate manoeuvres.
- divide your members into small groups and have them compete with each other at changing fuel filters, and starting the tractor.

The activities you can plan are limitless. Keep in mind that we want to allow the members to display knowledge gained during the project, and want to have a good time doing it. To make others aware of the members' accomplishments, be sure to invite guests and the media to your event.

RESOURCES

1. Reference is made in several of the meetings to publications from John Deere and Ford Tractor. There may be other companies with additional information and your local farm equipment dealer should be your first contact.

John Deere has a series of manuals called "Fundamentals of Service" and each of the manuals in this series covers a different section of the tractor. The reference in specific meetings is to these individual manuals of this series. You may be able to borrow these manuals from your local John Deere dealer or they are available on a purchase basis from:

JOHN DEERE - Post Office Box 1000, Grimsby, Ontario L3M 4H5
Check out the international John Deere web page at <http://www.deere.com>

Ford Tractor makes available to its dealers an ongoing series of service training films and manuals called "Trac-Com". The reference in specific meetings to these "Trac-Com" Videos and Manuals is by title and identification number. This material should be available on loan from any Ford dealer who is enrolled in the program.

2. Having a tractor available at all meetings would be very beneficial.
3. OMAFRA videos and films are available through the A.V. Library, Visual Communications Services, OMAFRA, 1 Stone Road West, Guelph, Ontario N1G 4Y2.

FEEDBACK- LET US KNOW WHAT YOU THINK!

The 4-H Resource Development Committee of the Ontario 4-H Council reviews and evaluates 4-H resources. Comments and suggestions about 4-H manuals and guides are always welcome. They may be sent to the following address:

4-H Resource Development Committee
Ontario 4-H Council
R.R. #1 Thornloe, Ontario P0J 1S0
1-800-937-5161
lduke@ntl.sympatico.ca

At the bottom of the table of contents page in the Members' Manual you will see the Kids Help Phone logo and number. Kids Help Phone is available to over 7 million children and teenagers throughout Canada.

It is a national, bilingual, confidential, toll free helpline staffed by paid, trained professionals. In response to the problems and concerns of our youth, Kids Help Phone provides a listening ear, emotional support, counselling, information and referrals. Children and teens from anywhere in Canada can call anonymously 24 hours a day, 365 days a year.

Children and teens can call about anything that is bothering them including - abuse; drugs; alcohol; conflicts with parents, friends or teachers; pregnancy; sexuality; suicide; or parental separation and divorce.

Please mention this number to your members and explain what it is for. Make sure they know that it is free and that they don't have to give a name or address.

**The Kids Help Phone answers 1500 calls a day...
2500 more get a busy signal. If you or your club or someone
you know would like to make a donation to the Kids Help Phone,
call 1-800-268-3062.**

MEETING ONE

TRACTOR HISTORY

SPECIAL NOTES FOR THIS PROJECT

1. Any page numbers refer to the Members' Manual unless otherwise indicated.
2. The Members' Manual has been designed as a reference source. Hopefully, the members can leave their manuals closed for most of the meeting, allowing them to observe, learn and take part in the discussion and other activities. It is not necessary - and usually not possible - to cover all the information given in the Members' Manual during the meeting.
3. Remember to refer to your volunteer's handbook - You will find many useful tips and ideas covering topics such as program planning, successful meetings, parliamentary procedure, effective communicating and presentation methods. Refer to your Volunteers' Handbook as you plan meetings. If you do not have a handbook, please contact your 4-H Association.
4. The Members' Manual title for each meeting includes the meeting topic and not the meeting number. This frees leaders to change the order of meetings and information without confusing the members. The schedule of meeting dates can be recorded on page 3.
5. A glossary of terms is provided at the end of the Members' Manual. It provides simple explanations of many terms used throughout the project. Members should read the glossary often until they are familiar with the terminology.

OBJECTIVES

1. To review the format and content of the project.
2. To review the responsibilities of a club executive, discuss their function in a smooth running club, and to hold an election of this executive.
3. To review and discuss the rich history of farm tractors and farm tractor manufacturers.

PREPARATION AND EQUIPMENT

1. Before this meeting, and all meetings, read through the Members' Manual and familiarize yourself with the material to be covered. Presentation ideas and suggestions for activities have been included in the Leaders' Guide to help you cover the material. Go over any sections with which you had difficulty.
2. Prepare name tags. Most clubs will have members who do not know each other at the beginning of the project, and some members (and leaders) may find it difficult to remember names. Name tags that can be used for every meeting will help introduce new friends. A "badge keeper" can be elected to collect these name tags at the end of each meeting and to hand them out at the beginning of the next.

TIME GUIDELINES

A time guideline has been provided for each section of the meeting. Please remember that this is only a guideline. The number of members, their maturity, specific interests and the way the meeting is structured will all influence the duration of specific activities.

IN A NUTSHELL	
Getting Acquainted Activity	10 min.
Getting Started	15 min.
Roll Call	5 min.
A Road Map to Good Meetings	20 min.
Tractors Through Time	20 min.
The Tractor Manufacturers	15 min.
Before The Next Meeting	10 min.
	95 min.

ROLL CALL (5 min) page 5

What make of tractor do you have at home? Why?

Everyone answers. While taking roll call, make sure that you take the time to positively reinforce each member's answer. This will help to increase the member's confidence in taking part in the meeting.

The roll call for this first meeting should be used to get the members involved and participating right from the start of the project. It is your job as a leader, especially at this first meeting, to have everyone involved. You have to keep the discussion going at the same time.

GETTING STARTED (15 minutes)

1. Begin with the 4-H pledge.
2. Welcome the members. Introduce leaders. Have members introduce themselves (if not already done). Introduce the youth leader (if this has been decided). Ensure that everyone has a name tag (optional).
3. Complete membership list.
4. Outline the opportunities members have such as taking part in the local fairs, 4-H Go For The Gold, 4-H Members' Conference, Future Leaders In Action etc...
5. Distribute "4-H Club Member Lives Here" and "4-H Project" signs if available.
6. Distribute the Members' Manuals.
7. Give a brief summary of what club is about and topics covered.
8. Discuss the members' requirements for the project (page 1). Outline any expectations you have of the members.
9. Briefly discuss the Achievement Program possibilities.

The remaining time is used for activities related to the meeting material. Try to keep the

members interested and involved by using a variety of techniques and activity co-ordinators such as the leaders, youth leader, guest or senior members.

The time shown for each section is only a guideline. Some sections will be completed more quickly, while others will take longer than shown, according to member interest and discussion. Avoid having a section drag on far past the suggested time. If necessary, simply supply the required answers for the members' books and move on.

A ROAD MAP TO GOOD MEETINGS (20 minutes)

It is important for everyone to become familiar with the basics of running a good meeting. Review with members the purpose of an agenda and the executive's responsibilities. Have the club members elect an executive. You may find the 4-H Volunteers' Handbook and the OMAFRA Factsheet, Procedures for Meetings (96-009) helpful.

TRACTORS THROUGH TIME (30 min. - depending on resources available) page 5

The format of your first meeting will have a great influence on the amount of time you have, and how you discuss the history of the farm tractor. This meeting could be held at the Ontario Agricultural Museum in Milton, the National Museum of Science & Technology, the Central Experimental Farm in Ottawa, the Lambton Heritage Museum in Grand Bend, any one of the numerous Steam and Antique shows across Ontario, or a local collector of old tractors. The Members' Manual contains the highlights of the six phases of tractor development.

In the Supplementary Information section, pages 15-18 of this guide, is the complete text of the information, prepared by William Tolton, and supplied by Peter Ledwith, Curator of Collections at the Ontario Agricultural Museum in Milton relating to the six phases. You may use this information to provide further details to the members should time and interest permit.

It might be fun to have a brainstorming session on what the members think the tractors of the future will look like.

THE TRACTOR MANUFACTURERS (15 min.) page 7

Have members form small groups. Each group could review one or two of the manufacturers and report to the rest of the club. Encourage them to be creative in their reporting. Some of the topics to be discussed might include: founders' names, old companies merged into new ones, special tractors they produced, or events that mark an important time in the development of the current tractor industry. The dealers for each of the listed names would also be a good source for information relating to the manufacturer.

BEFORE THE NEXT MEETING (10 min.) page 8

Briefly go over this section to ensure everyone is aware of it and to clear up any confusion.

Remind members that their Members' Manual should be brought to every meeting.

A completed "tractor inventory sheet" is on page 19 of this guide. The "item no." can be used where tractors may have a computer or other identification number. A photo may be attached in the lower right corner. Insurance companies like to see pictures if there is ever a claim.

There are numerous references made throughout the club that lead to farm machinery operators' manuals. Remind members that it is important and beneficial for them to bring an operators' manual to each meeting, if they can.

AFTER MEETING ONE

To prevent the members from becoming overwhelmed and dropping out, take time with new members to make sure they know what's expected of them. Make them feel welcome and offer to help them in any way you can.

FOR MEETINGS TWO TO SIX

The president chairs the meeting from the opening (with the 4-H pledge) and directs the secretary to read the minutes of the previous meeting and take roll call. Discuss any further business (e.g. next meeting, special 4-H or club activities, Achievement Program). The meeting is then turned over to the leaders (or youth leader) to lead the discussion of the meeting information.

REFERENCE MATERIAL AND RESOURCES**Books**

- Implement & Tractor - Reflections on 100 Years of Farm Equipment
Data Books Canada (519) 455-3552
188 Stronach Crescent
- London, Ontario N5V 3A1
- The Agricultural Tractor - 1855 to 1950
- The Farm Tractor - 1950 to 1975

SUPPLEMENTARY INFORMATION

The six phases in the development of the farm tractor are:

1. the tractor replaces the steam engine,
2. the tractor replaces the horse,
3. the tractor becomes an implement,
4. the tractor becomes sophisticated,
5. the tractor becomes universal, and
6. the tractor of current vintage (1988).

PHASE 1: THE TRACTOR REPLACES THE STEAM ENGINE

Example: the Fairbank Morse, the Sawyer-Massey or any of the early Rumely Oil Pulls

Theme: From about 1860, the steam engine was available for use on the farm to provide power for threshing machines and sawing wood. These were portable as opposed to traction engines. During the 1880's the technology of providing motive and stationary power in the same unit was developed. By 1910, steam traction engines could reach speeds of 2 miles an hour, but extreme weight and wide turning radius made their use in the small, hilly fields of Ontario farms difficult. Power supply for belt work was by far the steam engine's most important job.

In the period 1900-1920, the internal combustion engine gradually replaced the wood-burning steam engine in providing power to such uses. Lower cost per unit, faster ground speeds and more economical operation were the selling points of the early gas, kerosene or distillate burning tractors. The internal combustion engine required only one man to operate - steam machines required teams of men and horses to supply fuel and water. The early models were simply a different type of engine mounted on the old style heavy iron frames.

Initially these machines were designed as a stationary power supply as their forerunners had been.

Things to note about these early machines:

- the prominence of the belt pulley for belt power,
- the large weight to power ratio,
- the large cast iron gearing,
- the slow speeds of engines,
- the clumsy steering arrangements, usually chain operated,
- the simple bull-gear transmissions,
- the slow travelling speed and often only one speed in the simple transmission, and
- the weight of these machines damaged the land by compacting it.

PHASE 2: THE TRACTOR REPLACES THE HORSE

Example: the early Fordson tractor

Theme: Once the internal combustion engine had been found practical and inexpensive as a source of power, attempts were made to design smaller, more manoeuvrable machines to replace horses in pulling farm machinery in the fields. Many such machines were produced and tried in the 1910-1920 period.

The most successful of such machines was the one produced by the Ford Motor Co., beginning in 1917, in response to the need for more power during World War 1. This Fordson was the most successful tractor introduced in a modern factory, and was supported by the engineering and sales force of a major motor car firm. Within a few months, there were more than 100,000 on farms in North America, and well over a half million were eventually sold from 1917 to 1926. The technological developments featured by these machines sufficiently decreased the amount of expertise required to operate them. Women and boys on the farm were often called into service to drive the tractor.

Things to note about this type of machine:

- the small size,
- the importance of the pulling power and the smaller role of the drive belt pulley,
- automotive type steering,
- automotive type gasoline, upright engine,
- enclosed transmission and gear shift, and
- three working speeds (but still slow).

PHASE 3: THE TRACTOR BECOMES THE IMPLEMENT

Example: an early Farmall (introduced in 1924)

Theme: Once the tractor manufacturing industry had adopted automotive engineering such as transmission and steering, plus the small cylinder, high speed engine, tests were made so that a machine could be produced that would do more than just replace the horse as a pulling power. Machines were designed so that implements could be directly attached and thus the tractor became an implement in its own right. Power for pulled implements was supplied by a power take-off shaft. Although the implements still required an operator, power for that tool came from the engine of the tractor. The implement no longer depended upon the action of being pulled to operate. It ran at the same speed as the engine of the tractor.

Things to note about this type of machine:

- the frame slotted to mount implements (cultivator),
- the driver has clear visibility ahead,
- the adjustable wheels,
- higher speed engines and better engines (replaceable sleeves, etc.), and
- the power take-off, added so that the tractor could supply power directly to run an implement, so the tractor and implement become one unit for the purpose of working.

PHASE 4: THE TRACTOR BECOMES SOPHISTICATED

Example: Silver King 1936 or Ford-Ferguson 9N

Theme: Once the idea of a tractor being an integral part of the farm operation was accepted, attempts were made to design machines that would be more comfortable to use, easier to start, could be used at night, and so on. Thus, over a period of years from about 1922 to 1936, tractors became sophisticated.

A number of experiments were conducted in search of a means by which to make the tractor and implement a more efficient, economical and safe unit to operate. Harry Ferguson was successful in designing a system (the Ferguson System) which accomplished many of these tasks. The three-point hitch, patented in 1926, was equipped with a draft control feature, which caused the implement to be lifted slightly when the draft increased. This was a safety and technological innovation as it allowed the tractor to go through tough spots without getting bogged down or with a great deal of slippage.

The Ferguson System was further refined, and in 1936 the mechanics of the three-point linkage were improved, allowing weight to be transferred by the hydraulic system to the tractor's rear wheels.

Implement penetration was improved by design, not built-in weight. An implement could be easily controlled from the tractor seat automatically via the hydraulic system, and the hitch allowed for simple attachment or detachment. The three-point linkage also had a built-in safety feature that forced the rear wheels off the ground to spin harmlessly in the air when the implement hit an obstruction.

PHASE 5: THE TRACTOR BECOMES UNIVERSAL

Example: the Model "G" Allis-Chalmers or the Massey-Harris Pacer

Theme: The tractor came into being as a power plant to provide more power for farm operations than could be provided economically, safely or conveniently by the other sources of power then available: the steam engine, the windmill, and the horse.

Early tractors were heavy: i.e. the ratio of weight to horsepower was high - the steering was crude and the essential ingredient in the design was a power take-off or belt pulley by which to run other machines.

With the steady improvement in the internal combustion engine, the abandonment of the large bore, slow speed design in favour of the high compression, high speed automotive type engine, it became possible to make engines that were light, small and easy to start and operate.

Thus came into being the small tractor designed to operate as a general-purpose power source for country homes and estates as well as being a second machine on the farm. With such small, nimble, and easily operated tractors, the horse finally ceased to have any role as a power supply on the farm.

With the adaptation of direct mounted implements and clearer visibility from the driver's seat, these little (12 hp or less) machines became the universal "work horse" of the rural establishment, a general purpose implement designed and equipped to handle a wide range of chores.

Things to note about such tractors:

- small size and light weight,
- compact design, good visibility and nimbleness on the job,
- the job being done - mowing the lawn or levelling the laneway - becomes more important than the machine itself,
- relatively low cost, so that families living in the country, no matter how large or small their properties, now have such tractors as a matter of course, and
- such machines are readily available and can even be purchased out of such publications as mail order catalogues.

PHASE 6: THE TRACTOR OF CURRENT VINTAGE

The modern tractor is available in a wide range of sizes from small riding machines for country estates or as a second tractor on the farm, to big power plants with very complicated engines and fittings. Depending on the manufacturer, a tractor could have:

- fuel injected diesel engines,
- high power outputs,
- air conditioned cabs, and other electrical fittings,
- hydraulic transmissions,
- hydraulic couplings for implement power,
- operation monitors for exhaust manifold, crankcase, transmission temperature, engine speed, etc.,
- four wheel drive,
- dual wheels, and/or
- 15 to 18 speed power shift transmissions.

-
-

TRACTOR INVENTORY

Item: Ford 5600 Tractor Item No: OTS13

Make: Ford Model No: LA314M Serial No: C623163

Identifying Information 2 WD, DD cab, Blue Power Special, 16 speed transmission, 7.50
x 16 Frt tires, 18.4 x 30 Rear

Date of Purchase: July 1, 1999 Date of Manufacture: April '99

Purchased From:

Servicing Dealer:

Name: My Favorite Dealer

Same

Address: R.R. 10

City: Anywhere

Postal Code: K1G 1D4

Phone: (123) 456-7890

Misc: _____

Operator's Manual on File Yes Where: Shop Office File

Remarks: _____

(Attach a photo here if you wish.)

MEETING TWO PREPARING TO DRIVE - SAFELY

OBJECTIVES

1. To discuss the importance of safety.
2. To gain an understanding of the international symbols, increasingly being used on our tractors today.
3. To study the many safety features built into and taken for granted on the farm tractors of today.
4. To study the controls and functions of these controls in the safe use of a tractor.

PREPARATION AND EQUIPMENT

1. If your county/district/region has a local farm safety association, one of the members may be willing to help out with this meeting. Be sure to provide him/her with a copy of this information prior to the meeting. You can contact the Canadian Farm Safety Association via their web page at <http://www.fsai.on.ca/>
2. An attempt should be made to compare the safety features found on today's tractors with those of yesterday. This comparison could be made between farm tractors or between an old and new lawn and garden tractor. To facilitate this comparison you will need at least a couple of tractors of different ages to compare.

If you have a senior member who has access to these tractors on his/her own farm, it could become that member's special activity to make a comparison of the safety features.

IN A NUTSHELL

Roll Call	5 min.
Your Operator's Manual	10 min.
Controls and Instruments	40 min.
Starting Your Engine	5 min.
Let's Get It In Order	10 min.
Stopping the Tractor	5 min.
	75 min.
Optional: Activities	20 min.

ROLL CALL (5 minutes) page 11

YOUR OPERATOR'S MANUAL (10 minutes) page 12

Stress the importance of the manuals and have members look up the safety features that are on their tractors.

CONTROLS AND INSTRUMENTS (40 minutes) page 12

Rather than just looking at the symbols in the Members' Manual, the following match-up activity can be copied and given to members to complete. This activity can also be done verbally by showing the members the symbol and having them identify it. For extra excitement, split the group in two and turn it into a competition to see which team can guess the most symbols first.

INTERNATIONAL SYMBOLS

From the following list of descriptions, match each to the correct symbol by printing the letter in the blank.

- a. Engine speed
- b. Differential lock
- c. Continuously variable
- d. Creeper range
- e. Axle connect
- f. Hours recorded
- g. Hazard warning
- h. Engine oil pressure
- i. Rock shaft (lowered)
- j. Power take-off (off)
- k. Axle disconnect
- l. Battery charge
- m. Fuel cut-off

- n. Lights
- o. Warning
- p. Increase
- q. Decrease
- r. Reverse
- s. Forward
- t. Horn
- u. Diesel fuel
- v. Neutral
- w. Low range
- x. Air filter
- y. High range
- z. Fuel level

- aa. Remote cylinder (float)
- bb. Engine water temperature
- cc. Read operator's manual
- dd. Power take-off (on)
- ee. "Tortoise" slow or minimum
- ff. Rock shaft (raised)
- gg. Control lever operating direction
- hh. Pressurized open slowly
- ii. Remote cylinder (extended)
- jj. Warning! Contains asbestos
- kk. "Hare" fast or maximum
- ll. Remote cylinder (retracted)
- mm. Transmission oil pressure

1. 

2. 

3. 

4. 

5. 

6. 

7. 

8. 

9. 

10. 

11. 

12. 

13. 

14. 

15. 

16. 

17. 

18. 

19. 

20. 

21. 

22. 

23. 

24. 

25. 

26. 

27. 

28. 

29. 

30. 

31. 

32. 

33. 

34. 

35. 

36. 

37. 

38. 

39. 

Answers:

- | | |
|-------------------------------------|--|
| 1. a - Engine speed | 21. q - Decrease |
| 2. f - Hours recorded | 22. z - Fuel level |
| 3. bb - Engine water temperature | 23. l - Battery charge |
| 4. x - Air filter | 24. dd - Power take-off (on) |
| 5. hh - Pressurized open slowly | 25. j - Power take-off (off) |
| 6. h - Engine oil pressure | 26. ee - "Tortoise", slow or minimum setting |
| 7. g - Hazard warning | 27. kk - "Hare", fast or maximum setting |
| 8. e - Axle connect | 28. o - Warning |
| 9. k - Axle disconnect | 29. gg - Control lever operating direction |
| 10. c - Continuously variable | 30. ff - Rock shaft (raised) |
| 11. u - Diesel fuel | 31. i - Rock shaft (lowered) |
| 12. m - Fuel cut-off | 32. ii - Remote cylinder (extended) |
| 13. mm - Transmission oil pressure | 33. ll - Remote cylinder (retracted) |
| 14. d - Creeper range | 34. aa - Remote cylinder (float) |
| 15. y - High range | 35. b - Differential lock |
| 16. w - Low range | 36. cc - Read operator's manual |
| 17. jj - Warning! Contains asbestos | 37. v - Neutral |
| 18. n - Lights | 38. s - Forward |
| 19. t - Horn | 39. r - Reverse |
| 20. p - Increase | |

Review the instrument panel with members. Encourage members to explain the various instruments and controls.

STARTING YOUR ENGINE (5 minutes) page 16

Display any of the starting aids that you have and answer members' questions about them.

LET'S GET IT IN ORDER (10 minutes) page 17

This could be set up as a relay. Each team receives 10 slips of paper with one step written on each. First team to put them in the correct order wins. Take a photocopy of the list below for each team.

Start the engine.
Fasten seat belt.
Set parking brake.
Do a circle check of the tractor.
Study operator's manual for limits and specifications for work to be performed.
Check all oil levels.
Check that all gauges are functioning properly.
Check operation of clutch, brakes and steering.
You are ready to work.
Depress clutch.
If the tractor has a diesel engine let it warm up.

STOPPING THE TRACTOR (5 minutes) page 17

Same format used previously could be used here.

Number the following steps for shutting down an engine in the correct order.

Shut off engine.
Set the brakes or put transmission in park.
After the engine cools, fill the fuel tank with fuel (especially if a gas tractor).
Reduce the engine speed to an idle for a few minutes.
Perform a quick walk-around inspection.

BEFORE THE NEXT MEETING

Answer any questions members may have.

OPTIONAL ACTIVITIES (20 minutes)

Have a tractor available with a number of unsafe conditions. Divide the members into groups and in a pre-set time see which group can find the most unsafe items.

Or, organize a judging activity. Have members volunteer to go through the starting and stopping procedure. Other members could judge what s/he does correctly and what could be improved upon.

RESOURCES

Farm Safety Association - film, "Safety is no Accident".

Films, slides and video tapes are available through the farm safety consultant in your area or by contacting:

The Farm Safety Association
340 Woodlawn Road West, Suite 22
Guelph, Ontario K1H 7K6
Phone: (519) 823-5600, 1-800-361-8855
Fax: (519) 823-8880

The Farm Safety Association is also on the internet! Check them out, at <http://www.fasai.on.ca/>

MEETING THREE

TRACTOR SYSTEMS

OBJECTIVES

1. To identify the basic systems which make up a tractor.
2. To review in general terms the systems that make up the power train of the tractor.
3. To study in some detail one or two (as selected by your club) of the systems of the power train of the farm tractor.

PREPARATION

It would be helpful to have a mechanic at this meeting to help explain the systems and to answer questions.

IN A NUTSHELL	
Roll Call	5 min.
Introduction	15 min.
Tractor Systems	30 min.
Transmissions	15 min.
Differentials	10 min.
Hydraulics	10 min.
	85 min.
Optional: Review Questions	

ROLL CALL (5 minutes) page 19

INTRODUCTION (15 minutes) page 19

The material in this meeting can be best covered by spending the first 15 to 20 minutes walking around a tractor pointing out and very briefly identifying each of the systems which will be covered in this and the next meeting.

TRACTOR SYSTEMS (30 minutes) pages 19-20

If you have a tractor at the meeting you could use post-it notes to number the different systems. Members could then try to identify the system each member is on. Divide your members into groups and have them race to be the first group to match the system names and numbers correctly.

When reviewing the names of the system ask members to share any information they know about the function of the system.

An alternative approach would be to copy the diagram on the next page and have small groups of members write in the names of the systems. Looking at the location of the blank on the tractor will give a clue to the name of the system.

All words read from left to right or top to bottom.

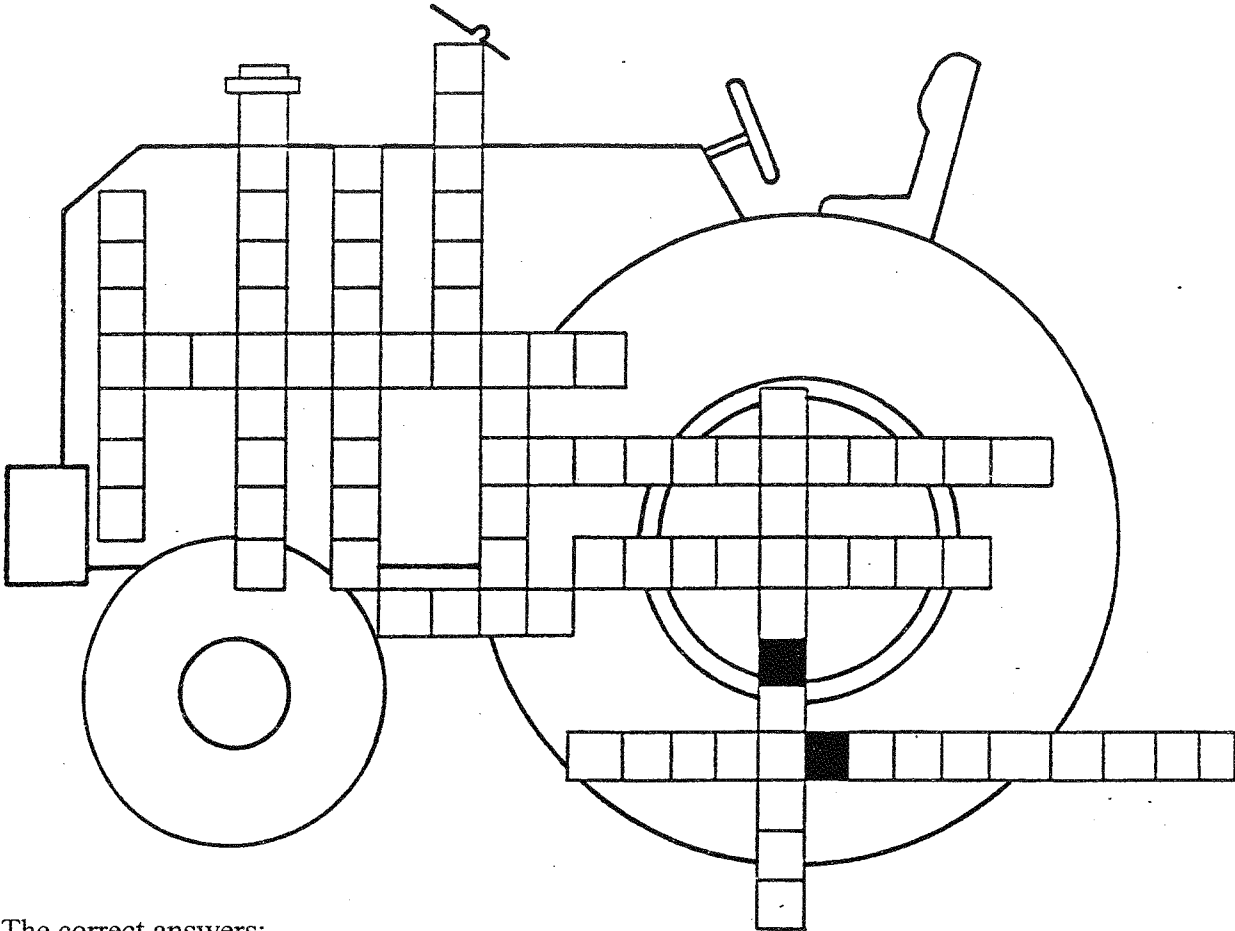

The correct answers:

- | | | |
|---------------|-----------------|--------------------|
| 1. electrical | 5. exhaust | 9. final drive |
| 2. fuel | 6. lubrication | 10. power take-off |
| 3. injection | 7. cooling | 11. hydraulic |
| 4. intake | 8. transmission | |

HOW TO PROCEED (select one or two systems to cover in detail and just cover the basics of the rest)

The support material you have will dictate how you proceed with the balance of the meeting.

If you have a guest speaker or a film that covers one or more specific system use that now and review the balance of the material as a summary of the power train and hydraulic systems of a tractor.

If you have access to examples of some of the components under review, you may have members who wish to demonstrate their abilities in dismantling and discussing these components. If this approach is to be used, the member involved should have time prior to the meeting to prepare.

TRANSMISSIONS (15 minutes) page 20

Have members discuss this chart in small groups. Each group could review one or two and give an explanation to the other members. Answer any questions the club members may have.

DIFFERENTIALS (10 minutes) page 22

The members might like to discuss the different types of differential locks. Here are some details.

A mechanical differential lock: is activated by hand or foot moving a lever which slides a collar, locking the left and right axles into one solid axle. Generally it is disengaged by a spring when the load on each axle is the same. Must be very careful when engaging "on the go".

A hydraulic differential lock: is one where hydraulic oil pressure presses a clutch disc against a plate. The clutch disc is attached to one axle, the plate to the other axle. The hydraulic pressure holds the lock on. When hydraulic pressure is cut off a spring pushes the clutch and plate apart. Can be engaged on the go.

A no-spin differential is normally engaged at all times but still allows for turning of the tractor. The design of the differential allows for a pre-set amount of speed variation of left wheel to right wheel before the two axles must turn together.

HYDRAULICS (10 minutes) page 23

Hydraulics is the most rapidly advancing system on today's tractors in terms of what they can do, how they do work, and how they do it more and more efficiently. It is an area where members as future farmers need a sound knowledge in the basics.

Use a hydraulic floor (bottle) jack to demonstrate figure 3 on page 25. The small plunger with hand pressure creates the pressure used to raise a load of tons.

The hydraulic systems on our tractors of today while much more complicated and sophisticated are still made up of the components shown on page 24.

BEFORE THE NEXT MEETING

Answer any questions members may have.

OPTIONAL REVIEW QUESTIONS

1. What is the main function of the tractor's "hydraulic system"?
A power transmitting medium
2. The engine, transmission, differential, and final drive are all part of the __.
Power train
3. Both the _____ and _____ transmissions are fluid drive transmissions.
Torque converter and hydrostatic
4. Which final drive does not give a speed reduction?
Straight axle
5. Name one advantage of the planetary final drive over the other three types.
Compact or durable
6. How can you tell the two PTO stubs - 540 and 1000 rpm apart?
540 rpm - 6 splines, 1000 rpm - 21 splines

RESOURCES

- John Deere and Company Fundamentals of Service Series
Power Trains FOS 4004B
Hydraulics FOS 1003B

MEETING FOUR

DIESEL ENGINES

OBJECTIVES

1. To review in general terms the systems that make up the farm tractor diesel engine.
2. To study in detail one or two (as selected by your club) of the systems of the diesel engine.

PREPARATION

It would be helpful to have a mechanic at this meeting to help explain the diesel engine and to answer questions.

IN A NUTSHELL

Roll Call	5 min.
Introduction	10 min.
Intake and Exhaust System	15 min.
Fuel System	15 min.
Cooling System	15 min.
Lubricating System	5 min.
	<hr/>
	60 min.

Optional: Review Questions

ROLL CALL (5 minutes) page 27

Name one advantage or one disadvantage of a gas, diesel or propane engine in a farm tractor.

INTRODUCTION (10 minutes) page 27

This meeting should start with a review of the systems of a diesel engine and then lead into a detailed discussion of one or two of the systems. There is a lot of material in the Members' Manual and you won't be able to cover all of it in detail. Extra resources, member make-up, and location of your meeting will all be factors in choosing which systems to concentrate on. Depending on the number of leaders for your club, members could split into groups (one group with each leader) and each group could cover one or two systems depending on member interest. Use your experienced members and the aid of any parts you can find to demonstrate how these specific parts or components operate. The disassembly and assembly of some engine parts could also be demonstrated.

INTAKE AND EXHAUST SYSTEM (15 minutes) page 27

The heat produced by compression can be demonstrated with a hand air pump. Let one member use the pump without attaching the hose to a tire (no compression of air), then attach the hose to a tire with some pressure and add more air. Compare how hot the pump gets when the air is compressed to the lack of heat when there is no pressure.

This heat caused by compression is the heat that is taken away by intercoolers in turbocharged engines, and it is also the heat which causes combustion in a diesel engine.

Intercoolers are sometimes added to turbocharged engines. As air is compressed it tends to get hot which makes it expand (like stepping ahead 3 steps and sliding back 1). An intercooler acts as a radiator between the turbocharger and the cylinders. The cooling of the compressed air allows even more air to be pushed into the cylinder, more fuel to be injected and more power to be produced.

FUEL SYSTEM (10 minutes) page 28

Have members look at a fuel system and identify the various components. They could also try to match the component with its function.

COOLING SYSTEM (15 minutes) page 29

Discuss the function of each component of the cooling system.

The operation of a thermostat can be demonstrated by placing it in a pot of water with a thermometer and heating it until it opens. Different temperature thermostats will open at different temperatures.

LUBRICATING SYSTEM (5 minutes) page 31

Display oil samples of various grades and viscosity so members can compare speed of flow.

BEFORE THE NEXT MEETING

Answer any questions members may have.

OPTIONAL REVIEW QUESTIONS

1. What is the major difference between a diesel engine and a gasoline engine?
In a gasoline engine an electrical spark is used to ignite the air fuel mixture. In a diesel engine the heat of combustion causes the ignition. The compression ratio of a diesel engine is much higher than that of a gas engine.
2. The biggest causes of problems in the diesel fuel system are _____ and _____ in the fuel.
Dirt and water

TRUE OR FALSE QUESTIONS

3. In a diesel engine, the intake system directs the air-fuel mixture into the cylinders.
False - air only
4. Intercoolers are used to cool the inner parts of a diesel engine.
Cools incoming air
5. The cooling system maintains the whole engine at a constant operating temperature.
True
6. Engine oil is only used to keep an engine lubricated.
False

RESOURCES

- Ford Trac-Com Video Turbochargers 010/8-85, Cooling Systems
017/10-86, Diesel Fuel Systems 005/11-84
- John Deere - Fundamentals of Service Series, Engines

MEETING FIVE

TRACTION

OBJECTIVES

To study the efficient use of the farm tractor through a review of traction as it is affected by:

- proper tire sizing
- tire slippage
- proper weighting
- proper tire inflation.

PREPARATION AND EQUIPMENT

Your local tire dealer would likely be more than happy to be involved in this meeting to discuss all facets of tire selection and use. The meeting might even be held at a tire store.

PROJECT COMPLETION

Read the note on page 37, this Guide. If you want members and parents/ guardians to complete the Project Summary sheet, copies should be given out at this meeting.

IN A NUTSHELL

Roll Call	5 min.
Introduction	5 min.
Tire Sizes, Types and Selection	20 min.
Wheelslip	10 min.
Weighting	15 min.
Tire Inflation	5 min.
	<hr/>
	60 min.

ROLL CALL (5 minutes) page 33

What size and type of tires are on a tractor?

INTRODUCTION (5 minutes) page 33

Stress to members how important it is to understand traction and how it will affect the performance of a tractor.

TIRE SIZES, TYPES AND SELECTION (20 minutes) page 33

Have a tire and rim available for members to find the tire size and to demonstrate how the size is measured.

If your meeting is at a tire store, have the members view examples of the different types of tires that are available. The illustration in the members' manual also shows some of the different types.

Have the members brainstorm to come up with a list of things to consider when choosing tractor tires. There is a list in the members' manual.

WHEELSLIP (10 minutes) page 35

Have members suggest factors that will affect wheelslip. Demonstrate any of these that you can. For example, operate the tractor in different soil conditions or greatly vary the load that is pulled.

WEIGHTING (15 minutes) page 36

Have members form small groups. Without using their members' manual, have them discuss how weight can be added to a tractor and how the operating weight of a tractor can be controlled. Have each group share its ideas with the rest of the club.

TIRE INFLATION (5 minutes) page 37

Demonstrate how a tire is properly inflated. Members would also benefit from seeing an underinflated and an overinflated tire.

BEFORE THE NEXT MEETING

The next meeting will make many references to each member's operator's manual. This should be mentioned at the close of the meeting to ensure each member brings his/her manual.

RESOURCES

- Ford Trac-Com Video Traction and Weighting 014/04-86
- Case IH
Product Information Tire Data PI-TD-485 (Revision 2)
- Successful Farming Farm Tire Handbook II
1716 Locust St.
Des Moines, IA
USA 50336
Phone (515) 284-3000

MEETING SIX MAINTENANCE AND SERVICE

OBJECTIVES

1. To introduce the members to the reasons for performing preventive maintenance on farm tractors - reduced operating cost.
2. To stress the importance of obtaining and using the proper operator's manual for each tractor owned.
3. To perform a pre-operational check of a tractor to show how quickly and easily it can be completed at home.
4. To demonstrate that the choosing of the proper fluids for a tractor cannot be done by guessing.

PREPARATION AND EQUIPMENT

1. Prepare for the roll call (see below). Samples of the eight oils listed on page 39 are required.
2. The planning for this meeting should include you becoming familiar with a tractor operator's manual. You should be able to demonstrate how to use the manual in obtaining the information required to do a good job of preventive maintenance.
3. It would be a good idea to perform a pre-operational check before the meeting to understand and become comfortable with this form.
4. If you are able to hold this meeting at a farm equipment dealership it may be possible to show (with the assistance of the dealer and a dynamometer) the effects of dirty or plugged air filters on the horsepower produced by the tractor.

IN A NUTSHELL

Roll Call	10 min.
Operator's Manual, Checking Fluid Levels	10 min.
Lubricating and Greasing	10 min.
Changing Your Engine Oil	15 min.
Servicing the Cooling System and Hydraulic System	5 min.
Maintaining the Fuel System	10 min.
A Clean Air Supply	5 min.
Pre-operational Checklist	15 min.
	80 min.
Optional: Activities	30-45 min.
Review Questions	

ROLL CALL (10 minutes) page 39

The set-up for this meeting's roll call will require advance preparation. If you have the liquids set out when the members arrive, they can be filling in the correct numbers prior to the formal call to order. Each of the liquids should be set out in a container not easily spilled or broken. Pay particular attention to safety in handling all flammable liquids.

It will be very difficult if not impossible to identify correctly each of the liquids, e.g. engine and hydraulic oil look the same. This should lead to a discussion about using only the known correct oil or other fluid. Something that looks like it may not be right. Members should also comment that these liquids should only be stored in their original, properly marked containers.

INTRODUCTION, OPERATOR'S MANUAL, CHECKING FLUID LEVELS (10 minutes) page 39

Take a few minutes to stress the importance of the operator's manual, not only in telling how to, but also in telling how not to. The use of an operator's manual applies to any and all the items used in our lives: cars, computers, hand power tools, appliances, as well as tractors and farm equipment.

Your discussion should point out that considerable time and expense is invested to produce these manuals. If the manufacturer did not feel the need to spend this money for a good manual they would not. When buying used tractors or equipment insist on receiving an operator's manual and turn in your manuals when you trade so that the next owner will benefit.

LUBRICATING AND GREASING (10 minutes) page 40

Have members form small groups and develop a list of characteristics for oils and greases. Have groups share ideas with the rest of the club.

You could demonstrate how to grease and lubricate.

CHANGING YOUR ENGINE OIL (15 minutes) page 40

Have members complete the chart individually and then compare as a group.

SERVICING THE COOLING SYSTEM AND HYDRAULIC SYSTEM (5 minutes) page 42

Point out to members the airflow passages that must be kept clean.

Discuss coolants and their purpose.

Stress to members the extreme danger of a hydraulic leak.

MAINTAINING THE FUEL SYSTEM (10 minutes) page 43

Have members suggest 4 steps to keep fuel clean. Refer to the members' manual to fill in any steps they overlook.

A CLEAN AIR SUPPLY (5 minutes) page 44

Have members locate the air filter on a tractor. You could demonstrate how to change this filter.

PRE-OPERATIONAL CHECKLIST (15 minutes) page 44

Have members complete one at the meeting and one at home.

OPTIONAL ACTIVITIES (30-45 minutes)

There are numerous activities that can be performed during this meeting:

1. Change the engine oil.
2. Change the engine oil filter.
3. Change the fuel filters.
4. Locate areas to grease or grease the complete tractor.
5. Repack front wheel bearings.

These activities should be performed in small groups with a group leader in charge. It might be possible to have 2 or 3 activities on the go with the groups rotating to each station.

BEFORE THE NEXT MEETING

Answer any questions members may have about doing a pre-operational check.

OPTIONAL REVIEW QUESTIONS**TRUE OR FALSE QUESTIONS**

1. If the engine oil appears black, it is dirty and needs to be changed.
False - Sulphur from the combustion of diesel fuel will turn new oil black very quickly after an oil change.
2. If an air filter gets plugged up, it's better to run without a filter instead of restricting airflow.
False - No filter will allow dirt into the engine, that is the worst possible solution.
3. Electrical tape is a good, quick fix for a small leak in a hydraulic hose.
False
4. Cylinder wall pitting can happen in any heavy-duty diesel engine.
True
5. Engine oil and hydraulic fluid may be used interchangeably if you run out of one or the other.
False

RESOURCES

- Ford Trac-Com Video Diesel Fuel Systems 005/11-84
 Cooling Systems 017/10-86
- BP Oil and/or Ford New Holland The Oil in Your Engine

PROJECT COMPLETION

A Certificate of Completion and a Project Summary have been included in this Guide, pages 33 - 35. Your signature on either of these indicates you feel that the member has completed the project to the best of his/her ability. Space is provided for you to add some individual comments to offer encouragement to the member. The Project Summary sheet also asks for written feedback from the member and his/her parents/guardians. (The questions on this sheet have been selected from the informal evaluation sentences, listed below.) Select whichever sheet best meets your needs and make copies for the members.

It is recommended that the certificates not be awarded until the Achievement Program. If you give them out before this time, some members mistakenly assume that they don't need to participate in the program.

It Worked For Us!

Your experience in leading this club would be helpful to another leader in your area. You are encouraged to make some comments about the project, what resources you discovered locally and the members' feelings about the project and pass this information on to your 4-H Association. The Resource Development Committee of the Ontario 4-H Council is interested in your comments too. Their address is in this Guide, page 4.

INFORMAL EVALUATION

Take a few minutes at the last meeting to do an informal evaluation with members. One way to do this is to ask them to complete one/all of the following sentences.

- I joined this club because ...
- I really enjoyed ...
- I didn't enjoy ...
- I had a hard time ...
- My favourite meeting activity was ...
- My least favourite meeting activity was ...
- If I was to take this project again, I would change ...
- I learned ...
- I've changed ...
- I'm glad ...

<p>THANK YOU FOR BEING A VOLUNTEER 4-H LEADER!</p>
--

PROJECT SUMMARY - FARM MACHINERY
(Complete at the end of the project)

A. Member Comments:

1. I joined this club because ... _____

2. I really enjoyed ... _____

I didn't enjoy ... _____

3. If I was to take this project again, I would change ... _____

4. I learned ... _____

5. I'm glad ... _____

B. Parent/Guardian Comments: _____

C. Leader Comments: _____

This project has been completed satisfactorily.

Member _____ Leader _____

Date _____ Leader _____



FARM MACHINERY

TRACTORS

**Congratulations on successfully completing
this 4-H project.**

Date

Club Leader's Signature



LEARN TO DO BY DOING

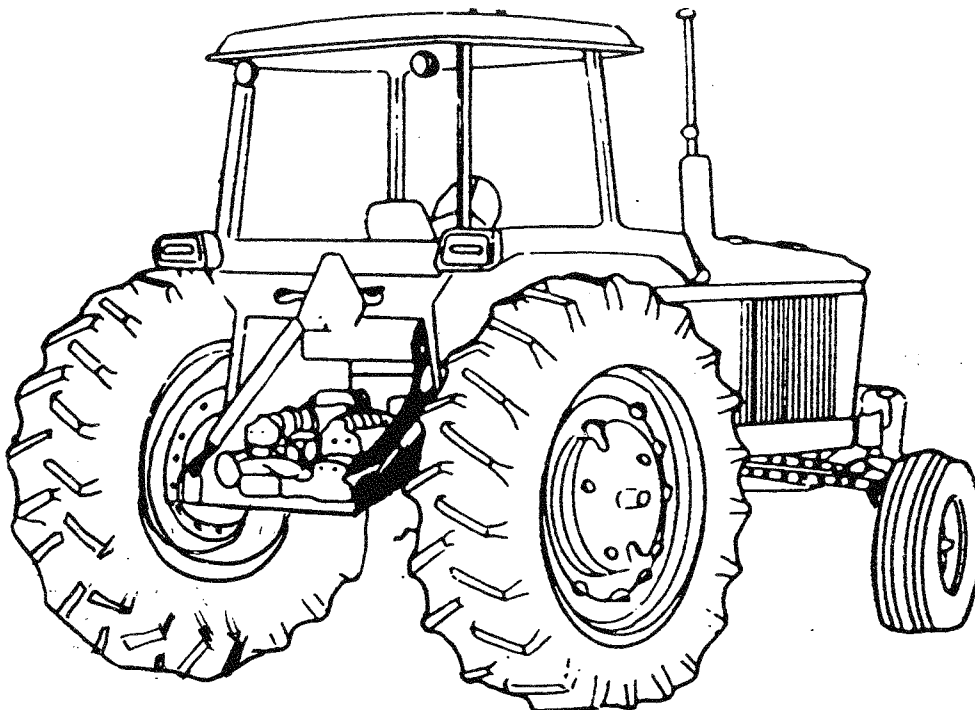

FARM MACHINERY - Tractors

NAME

AGE

CLUB

NUMBER OF CLUBS



Ontario
4-H Council



Ministry of Agriculture,
Food and Rural Affairs

4-H 600 00 ME



The Ontario 4-H Program provides opportunities
for the personal development of youth.
<http://www.4-hontario>

THE 4-H PLEDGE

"I pledge:
My Head to clearer thinking
My Heart to greater loyalty
My Hands to larger service
My Health to better living
For my club, my community and my country."

TABLE OF CONTENTS

	PAGE
INTRODUCTION	1
OBJECTIVES	1
GENERAL REQUIREMENTS	1
MEETINGS: Tractor History	5
Preparing to Drive - Safely	11
Tractor Systems	19
Diesel Engines	27
Traction	33
Maintenance and Service	39
GLOSSARY OF TERMS	47

This project was originally prepared by
Allen Hills, Ashton, and updated in 1999 for the Ontario 4-H Council.
Special thanks to the original advisory committee:
Glenn Barkey, 4-H Member, Blackstock, Jack Price, 4-H Club Leader, Harrowsmith
and OMAFRA staff.

©Copyright Ontario 4-H Council and Queen's Printer For Ontario, 1999.

The Ontario 4-H Council and the Ontario Ministry of Agriculture, Food and Rural
Affairs jointly funded this project.

FARMMA00M



ISBN 0-7778-8836-X

<http://kidshelp.sympatico.ca>

WELCOME!

4-H is a program for youth that also involves adult volunteers, parent/guardians and the community. The aim of 4-H is to develop your skills, knowledge and attitudes in the spirit of fun and friendship. The Ontario 4-H Program values the concept of "learn to do by doing" and will continue to support opportunities for experiential learning.

The program also values and encourages grassroots involvement and shared decision making of all participants.

INTRODUCTION

The 4-H Farm Machinery project focuses on the single most important piece of farm machinery - the tractor. In this project you will learn something about the history of the tractor, how a tractor works, how a tractor should be prepared to work, how to keep your tractor working, and most importantly, how to operate the tractor safely on your farm. A properly equipped, properly serviced and safely operated tractor is not only enjoyable to operate but is an important factor in a profitable farm operation.

During this project you will learn more about your tractor as we all "Learn To Do By Doing".

OBJECTIVES

1. To expand your knowledge of the tractors found on our farms yesterday and today.
2. To promote the efficient use of tractors.
3. To provide an increasing opportunity for you to learn to operate and care for tractors skilfully, safely and economically.
4. To share this new knowledge with other 4-H members and tractor owners.

GENERAL REQUIREMENTS

A member will complete a project satisfactorily by:

1. participating in at least 2/3 of his/her own club meeting time;
2. completing the project requirements to the satisfaction of the club leader(s);
3. taking part in an Achievement Program.

SPECIAL ACTIVITIES

Individual clubs will decide if members will be required to complete a Special Activity. Here are some suggestions for Special Activities. Encourage the members to display, present or share in some way the results of their activity. This could be done at a club meeting, the Achievement Program or another 4-H event.

Members may complete one special activity chosen from the list below. With your leaders' approval, some activities may be done in pairs or groups. Give a brief report to the club at one of your meetings. You can also design your own special activity, with the approval of your club leader. Here is a list of suggested activities.

- Demonstrate how and why packing of the front wheel bearings of a tractor is done.
- Demonstrate the proper method of changing, bleeding the fuel system and starting the tractor.
- A research project on the history of a tractor manufacturer or on the development of a specific feature of tractors, ie. diesel engines, radial tires.
- The restoration and display of an old tractor.
- A slide presentation or display showing the 6 phases of tractor development.
- Researching the dos and don'ts of disposing of used engine oils. The Ministry of the Environment would be a good contact.
- Take responsibility for collecting, displaying, and identifying the parts that make up one of the systems of a tractor.

MEETING SCHEDULE

	DATE	TIME	PLACE
MEETING ONE			
MEETING TWO			
MEETING THREE			
MEETING FOUR			
MEETING FIVE			
MEETING SIX			
ACHIEVEMENT PROGRAM			

FEEDBACK

The 4-H Resource Development Committee of the Ontario 4-H Council reviews and evaluates 4-H resources. Comments and suggestions about 4-H manuals and guides are always welcome. They may be sent to the following address:

4-H Resource Development Committee
 Ontario 4-H Council
 R.R. #1 Thornloe, Ontario P0J 1S0
 1-800-937-5161
 lduke@ntl.sympatico.ca

Get Involved

Be willing to let your name stand for an executive position. It is a rewarding and fun experience. Following your club's elections, complete this club executive chart.

CLUB EXECUTIVE:

	Name	Phone
PRESIDENT	_____	_____
VICE-PRESIDENT	_____	_____
SECRETARY	_____	_____
TREASURER	_____	_____
PRESS REPORTER	_____	_____
OTHER	_____	_____

CLUB MEMBERSHIP:

Members, Phone	Members, Phone
_____	_____
_____	_____
_____	_____
_____	_____
_____	_____
_____	_____
_____	_____
_____	_____



Leaders, Phone	Leaders, Phone
_____	_____
_____	_____

4-H Association President, Phone	4-H Association Secretary, Phone
_____	_____

OMAFRA Contact, Phone

Tractor History

ROLL CALL

What make of tractor(s) do you have at home? Why?

TRACTORS THROUGH TIME

Today's tractors are marvellous, complex machines. Tractors are used virtually everywhere and in all seasons of the year. You don't have to be on a farm to see them operating. Drive along any country road, highway or city street and you can see tractors mowing lawns, tilling a garden, landscaping a park, or when they are equipped with a backhoe, digging ditches or performing other chores.

Farm tractor development is a fascinating part of agricultural history. The first tractors to be found on our farms were built more than 100 years ago. They were crude and sometimes unreliable, but they were also the start of an evolution in farming and the forerunners of the modern tractor.

DEVELOPMENT OF THE FARM TRACTOR

The Farm Museum has identified six phases in the development of the farm tractor.

1. THE TRACTOR REPLACES THE STEAM ENGINE

- 1900 to 1920
- internal combustion engine on old style steam engine frames
- one man to operate, an improvement over the steam engine which required greater manpower

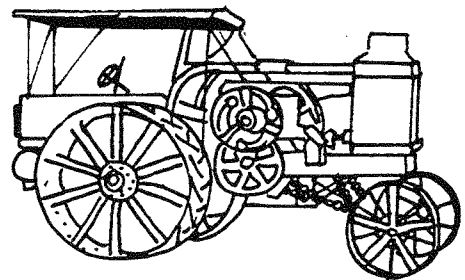

1911 Rumely Oil Pull

2. THE TRACTOR REPLACES THE HORSE

- 1910 to 1920
- smaller and more manoeuvrable
- easier to operate
- Fordson from Ford Motor Company best example, with their mass production and affordable prices

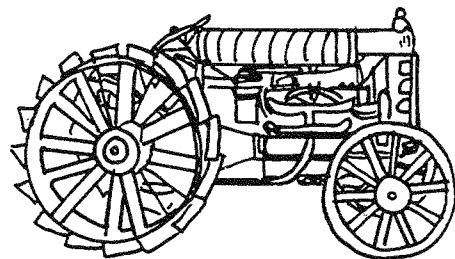

1917 Fordson

3. THE TRACTOR BECOMES AN IMPLEMENT

- tractors designed to do more than pull equipment
- power take-off - 1918
- attachments mounted on or around the tractor
- automotive engineering applied to tractors in areas of steering, transmissions, higher speed engines with pressure lubricating
- the early Farmall - 1924 - best example

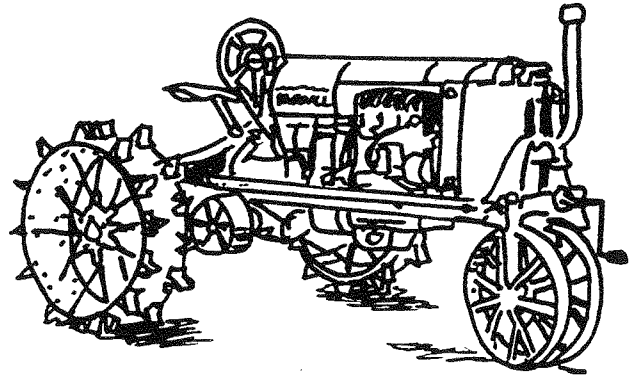

McCormick-Deering Farmall (2-plow)

4. THE TRACTOR BECOMES SOPHISTICATED

- tractor now made easier, more comfortable to operate
- lights, starters, rubber tires
- Ferguson 3 point hitch patented in 1926 is major advance
- in 1936, draft control added to 3 point hitch hydraulic depth control
- Ford-Ferguson is best example

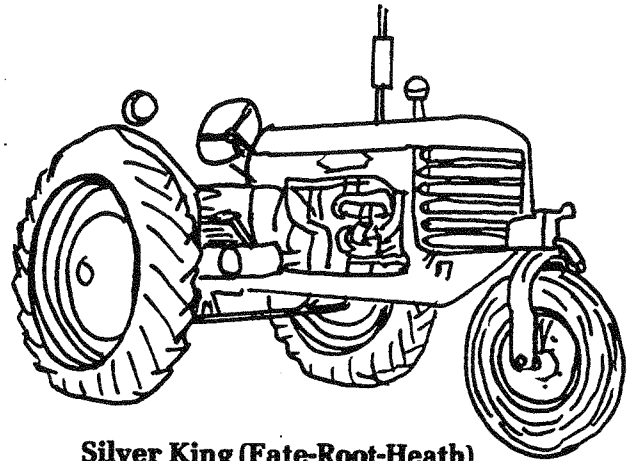

Silver King (Fate-Root-Heath)

5. THE TRACTOR BECOMES UNIVERSAL

- late 1930s
- improvements in engineering and design
- engines lighter, easier to start, more dependable
- wide range of equipment available to attach to tractor affluent society creates demand for tractors to perform chores on small country properties
- distribution systems make tractors and attachments readily available
- the "G" Allis-Chalmers and Massey-Harris "Pacer" are examples

6. THE TRACTOR OF CURRENT VINTAGE

- 1960s to today
- horsepower range 10 to 500 hp
- safety now an important factor of design
- diesel engines have become universal
- sophisticated hydraulics
- wide range of transmission options

THE TRACTOR MANUFACTURER

Equally fascinating, for anyone involved with tractors and equipment in recent years, has been the consolidating of the large number of tractor builders and manufacturers (over 500 have tried to make tractors) to the relatively few manufacturers/distributors remaining in the business today.

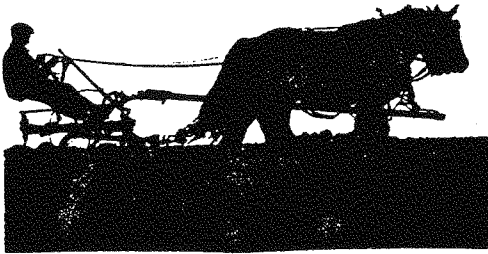
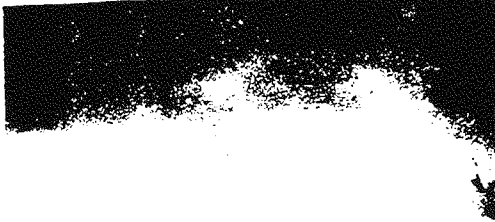

In 1918, 186 manufacturers were making tractors; by 1950 the number of active manufacturers had decreased to 50, and with the current round of mergers and buyouts completed there are now less than 20 tractor manufacturers still in the business.

Interest in the history of our farm tractors is evidenced by the large number of steam and antique tractor shows held each year in Ontario. In addition to these, the antique plowing classes at many plowing matches are beginning to outnumber the regular classes. The history of the tractor industry has been and continues to be well documented, with a number of publications and books available on the topic.

Following are a number of the major North American tractor companies of today. Some interesting facts about the background of each of the manufacturers are included. The information covers founders' names, old companies merged into new ones, special tractors they have produced and events that mark an important time in the development of the tractor industry. Your club could discuss some of the points you find particularly interesting.

New Holland

- New Holland was created in 1991 by a merger between Ford New Holland and Fiatagri.
- Ford Motor Company acquired New Holland in 1986, and Versatile in 1987 to form a new company called Ford New Holland.
- Ford was the first with an assembly line, mass produced tractor (the Fordson) in 1917.
- 9N Tractor with Ferguson System hydraulic lift introduced in 1939.

Case International

- J.I. Case Threshing Machine Co. established by Jerome I. Case in 1842.
- J.I. Case Threshing Machine Co. incorporated in 1880.
- The J.I. Case Threshing Machine Co. changed its name to J.I. Case Co. Inc. in 1929.
- The International Harvester Co., incorporated in 1902.
- International Harvester introduces a PTO in 1918.
- International Harvester introduced the Farmall line in 1924.
- Tenneco, owners of J.I. Case, purchased International Harvester and formed Case IH.

John Deere

- Established by John Deere in 1837.
- Purchased the Waterloo Gasoline Engine Company in 1918.
- Name changed to John Deere Tractor Co. in 1926.
- First general-purpose tricycle tractor introduced in 1931.

Deutz Allis

- Allis-Chalmers Manufacturing Co. incorporated in 1913.
- Allis-Chalmers first to introduce Firestone produced rubber tires on its tractors in 1932.
- Deutz, a German manufacturer purchased Allis-Chalmers and formed Deutz Allis.

Massey Ferguson

- The Massey-Harris Co., an amalgamation in 1891 of the Massey and Harris companies dating back to 1847 (Canadian manufacturers).
- Massey-Harris purchased J.I. Case Plow Co. in 1928.
- First Ferguson tractor produced by Harry Ferguson in 1948.
- Perkins engine acquired by Massey Ferguson in 1959.

Allied Corporation

- Oliver Farm Equipment Co. formed in 1929, by merging the Oliver Chilled Plow Works, the Hart-Parr Co. plus two other small manufacturers.
- Oliver introduces first continuous running PTO in 1948.
- The Minneapolis-Moline Power Implement Co. was incorporated in 1929.
- Oliver, Minneapolis-Moline, and Cockshutt -- merged into one company called White.
- Allied Corporation purchased White, New Idea, and a number of small equipment manufacturing companies.

Agco

- Agco Corporation was formed in 1990 when management staff from Deutz-Allis purchased the company and changed the name to Agco-Allis.
- Agco purchased the White Tractor Company in 1991 and Massey Ferguson Industries in 1993.
- They also have North American distribution rights for Landini and Same.
- Agco also has ownership or part ownership of Hesston, Western Combine (Massey Combines), Blackmachine, White-Hew Idea, PMI, Gleaner, Tye, Farmhand, and Glenco.

BEFORE THE NEXT MEETING

As we progress through this tractor project we will refer repeatedly to the operator's manual for a tractor. So your first task is to find an operator's manual.

A lot of important information is needed to maintain, adjust, service and drive your tractor. To record the information, complete a "tractor inventory" for each tractor you may have occasion to drive. (Including lawn and garden tractors.)

One inventory sheet has been supplied, page 9. If you have additional tractors or equipment you may wish to copy this sheet.

<p>WE WILL OFTEN BE REFERRING TO THE OPERATOR'S MANUAL FOR A TRACTOR. YOU SHOULD BRING ONE WITH YOU TO EACH MEETING.</p>
--

TRACTOR INVENTORY

Item: _____ Item No: _____

Make: _____ Model No: _____ Serial No: _____

Identifying Information: _____

Date of Purchase: _____ Date of Manufacture: _____

Purchased From: _____ Servicing Dealer: _____

Name: _____

Address: _____

City: _____

Postal Code: _____

Phone: _____

Misc: _____

Operator's Manual on File _____ Where: _____

Remarks: _____

(Attach a photo here if you wish.)

Preparing To Drive - Safely

ROLL CALL

Name a safety feature on a tractor.

INTRODUCTION

Preparing to operate the tractors on your farm must always start with a discussion about safety. The Farm Safety Association Inc. reports that "tractors are the number one killers in the farm workplace. Approximately 40 percent of all farm fatalities in Ontario can be directly or indirectly linked to tractor use."

It is important to recognize that a farm tractor does nothing by itself - a human operator is required. Then the tractor can do the work it is intended to do, or it can cause injury or death.

SAFETY FEATURES

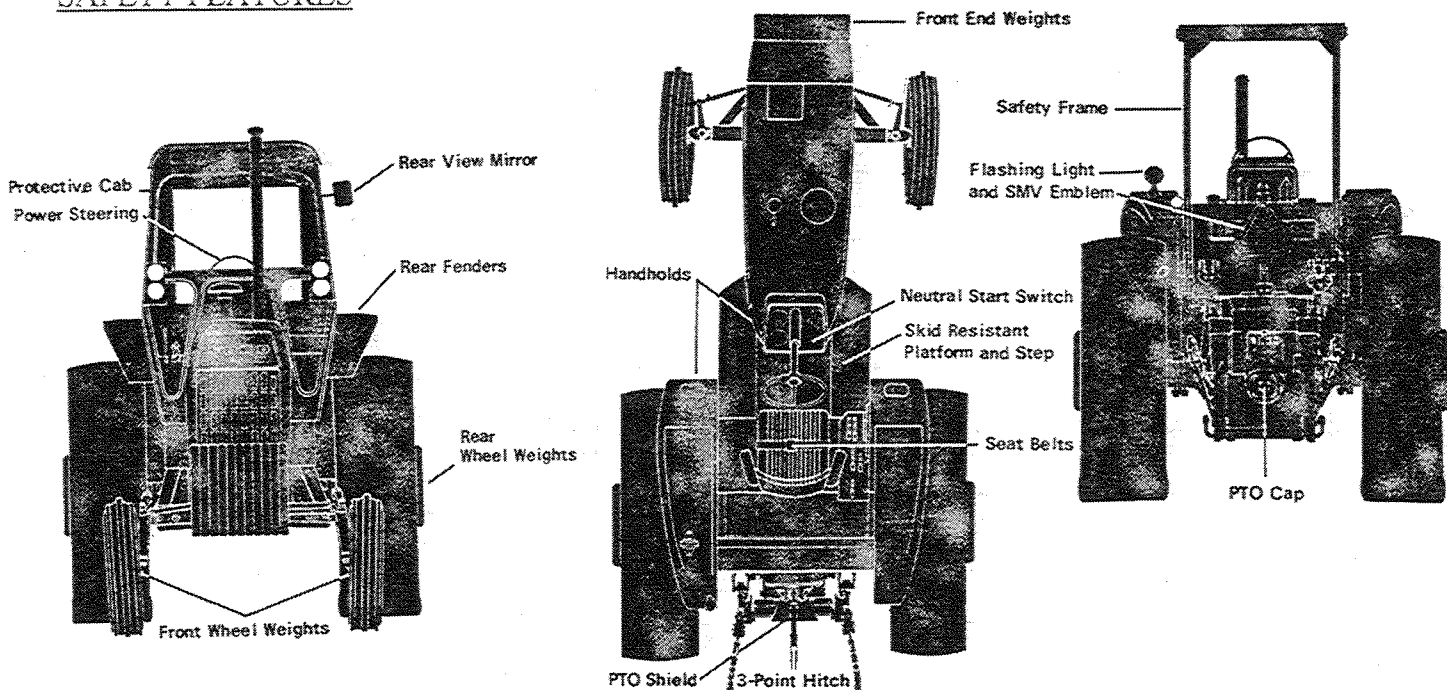

The illustration above shows the typical safety features you will find on most current tractors. Knowing where these special features are located and how to operate and control them can be one of the safest practices you will learn when preparing to drive.

THE OPERATOR'S MANUAL

The operator's manual should have a similar illustration or listing of safety features for a tractor. Before operating your tractor, take a few minutes to review this illustration.

Just as we will make extensive use of an operator's manual in our discussion on service and maintenance, we will draw many of the specific details about the safe and proper operation of tractors from the same book.

Tractors are complex machines and all makes and models are different. While many tractors - and especially those from the same manufacturer - may have similar features, various models have different operating specifications and limits. These must be followed if the tractor is to perform efficiently and last a long time. Make sure that you are using the correct manual for a given tractor!

IT'S IN YOUR HANDS

Skill in tractor operation can only be developed through countless hours behind the wheel. It is possible, of course, for an experienced operator to have a serious accident. Familiarity can lead to carelessness, and a seasoned operator may push too hard to beat the weather or the clock.

All tractor operators must be alert and devote all of their attention to the task at hand.

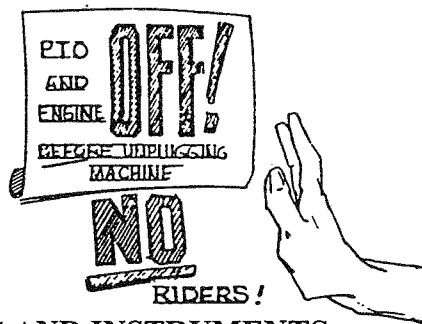







































CONTROLS AND INSTRUMENTS



Every operator's manual produced today will give an explanation of the controls and instrument panel, the proper sequence for starting up and shutting down the tractor, and there may be instructions on reading the instruments. Today we are seeing more and more tractors produced in one country or area for distribution to many countries in different parts of the world. The many languages involved in this type of marketing arrangement make it very difficult to use words or phrases for instruments or controls.

For this reason, a set of universal symbols has been developed to be used on all controls and in all instrument panels. They are pictured below.

- | | | | |
|---------------------------------|---|---------------------------------------|---|
| 1. engine speed |  | 22. fuel level |  |
| 2. hours recorded |  | 23. battery charge |  |
| 3. engine water temperature |  | 24. power take-off (on) |  |
| 4. air filter |  | 25. power take-off (off) |  |
| 5. pressurized open slowly |  | 26. tortoise" slow or minimum setting |  |
| 6. oil pressure |  | 27. "hare" fast or maximum setting |  |
| 7. hazard warning |  | 28. warning |  |
| 8. axle connect |  | 29. control lever operating direction |  |
| 9. axle disconnect |  | 30. rock shaft (raised) |  |
| 10. continuously variable |  | 31. rock shaft (lowered) |  |
| 11. diesel fuel |  | 32. remote cylinder (extended) |  |
| 12. fuel cut-off |  | 33. remote cylinder (retracted) |  |
| 13. transmission oil pressure |  | 34. remote cylinder (float) |  |
| 14. creeper range |  | 35. differential lock |  |
| 15. high range |  | 36. read operator's manual |  |
| 16. low range |  | 37. neutral | N |
| 17. Warning! Contains asbestos. |  | 38. forward |  |
| 18. lights |  | 39. reverse |  |
| 19. horn |  | | |
| 20. increase |  | | |
| 21. decrease |  | | |

Can you find any additional symbols that are used in your operator's manual?

INSTRUMENT PANEL

Just as the instrument panel on an airplane allows the pilot to monitor the plane, the instrument panel of a tractor will tell you if all systems are working properly. Among the gauges, lights, dials, levers and buttons on the instrument panel you will find the following.

1. An oil pressure gauge is used to show the amount of pressure in the oil lubrication system. This gauge could be for the engine, transmission or hydraulic system. Warning lights are sometimes used in place of direct-read gauges. After starting the tractor it may take a few moments for the oil pump to build up the required pressure. This is normal, but if the correct pressure is not obtained after a few seconds, shut off the tractor and investigate.
2. The charge indicator (ammeter or voltmeter) can be either a gauge or a warning light. This instrument shows whether the generator or alternator is charging the batteries at the proper rate.
3. The fuel gauge, telling how much fuel is left in the tank, is the most looked at gauge in the instrument panel, and so it should be. Much time can be lost, because of the difficulty in starting a diesel engine after it has run out of fuel. Some tractors today have a fuel pressure gauge to show when fuel filters are plugged with dirt.
4. All tractors today have a tachometer to show how fast the engine is running. The tachometer is read in revolutions per minute (RPM), and may be a dial gauge or on newer tractors, a digital readout.
5. The hour meter or proofmeter may be built into the tachometer, may be a separate gauge or may be part of a digital readout system. An hour meter shows the number of hours the engine has operated. Care should be taken in reading an hour meter. The type of meter and the way it is operated can affect the number of hours showing. Some hour meters are different, some count and record hours whenever the key is on, whether the engine runs or not. Others record the number of hours an engine is running without allowing for the speed at which the engine is running, and some record hours at a specific engine speed (if the engine runs slower fewer hours are counted, faster and more hours are counted).
6. There may be several temperature gauges or warning lights on your tractor. The engine, transmission, and hydraulic systems all have "best" operating temperatures, and these gauges with your operator's manual will tell you what that temperature is. A high temperature is usually the first sign of a plugged or dirty radiator or oil cooler. Keep an eye on these gauges.

CONTROLS

The controls on a tractor enable you to "tell" the tractor what to do. In order for you to become a safe and skilled tractor operator, you must know where each control is, and how it functions so that you can react in an emergency to stop the tractor or operation of an attachment.

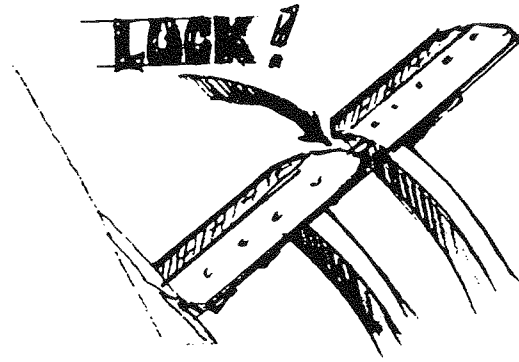

1. A clutch is used to disengage or disconnect an application of power. The main or engine clutch is disengaged to allow the shifting of gears. The shift levers are in different numbers, different locations and use different shifting procedures on nearly every tractor. The operator's manual is where you will find how to use the clutch and gearshifts on your tractor properly.

To smoothly engage a clutch requires practice, and you'll probably jolt around a bit at first! This practice should be done in an area and application which allows you to make some mistakes without causing any injuries or damage.

2. The engine speed control or throttle controls the speed and thus the power of the engine. Most tractors today have a "hand throttle" and a "foot throttle". The hand throttle is used where a set speed is to be used for a long period of time, and the foot throttle is used when you wish to constantly change the speed of the engine.

Tractor speed is a major cause of tractor related accidents. Too much speed causes too many accidents!

The tachometer and/or operator's manual will tell you the proper engine speed for the tractor to get the proper PTO speed and the most efficient operation of the tractor engine. It may also suggest a speed below which you should not let your engine run for too long a period.

3. Tractor brakes have three functions:
 - to assist two-wheel drive tractors in making tight turns in field operations,
 - for stopping the tractor, and
 - for parking the tractor.

All two-wheel drive tractors are equipped with two brake pedals, one for each rear wheel of the tractor.

Pressing one pedal at a time will cause the tractor to turn in the direction of the brake pressed. This is a benefit in field applications but becomes a serious safety problem when travelling in "road gear". A lock is always supplied to lock the two brake pedals together when driving at high speeds. Use it and keep the brakes adjusted evenly.

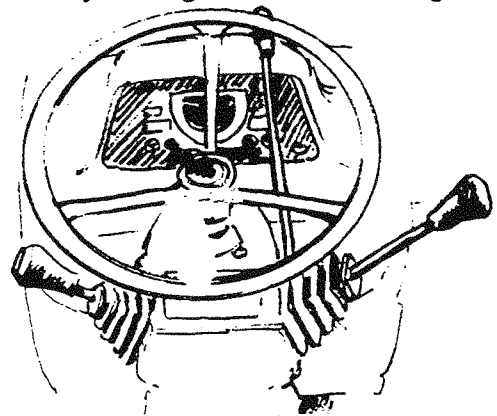

Always apply the parking brake before leaving the tractor. Many new power-shift and hydrostatic transmissions do not provide engine braking when the tractor is shut off, and you may find the tractor has moved when you return.

4. The steering on a tractor may be "standard", "power-assist" or hydrostatic. A tractor with some form of power steering is a safer tractor to operate because steering is less tiring and more controlled. However, care must be taken if the engine stalls or is shut off as some tractors don't have any steering control when the engine is off.

Most four-wheel drive tractors steer by pivoting (articulating) the tractor in the centre. Tractors with this type of steering can crush a person standing near the pivot point when the tractor is turned. Not allowing anyone near a tractor when the engine is running is especially important with a four-wheel drive tractor. The operator must stay in the driver's seat.

5. The hydraulic levers control the operation of the 3 point hitch, and the remote cylinders. Study the operators' manual for the location and proper operation of these controls.

Most 3 point hitch hydraulic systems have two or three modes in which they can be operated. Two of these will be: position control and draft control. The position control setting allows the operator to control precisely the position of the 3 point hitch with corresponding moves of the control lever. The other settings do not allow this same control. Therefore, always set the mode of operation of the 3 point hitch hydraulics to position control when hooking up, unhooking, or adjusting 3 point hitch equipment.

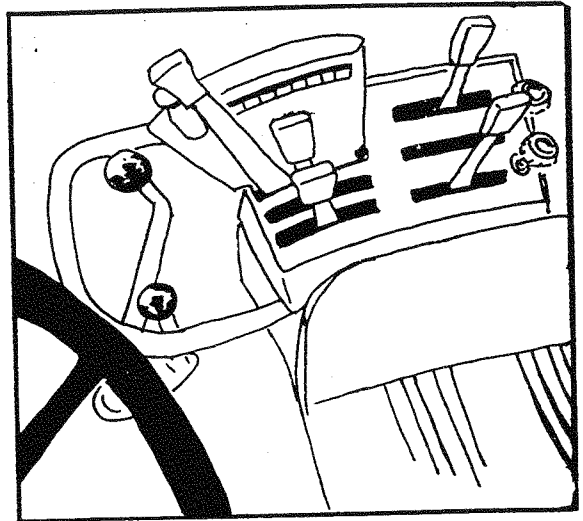

STARTING YOUR ENGINE

A diesel engine depends on the heat of combustion to fire the fuel injected into the cylinder. Because of this, and because of the cold climate we live in, most diesel engines need some kind of help in getting started. Listed below are some starting aids.

- block heaters (120 volt)
- glow plugs
- manifold heaters
- ether
- battery warmers
- pup engines

LET'S GET IT IN ORDER!

The following is a list of the steps you would perform in starting an engine.

1. Study operator's manual for limits and specifications for work to be performed.
2. Do a circle check of the tractor.
3. Check all oil levels.
4. Fasten seat belt.
5. Set parking brake.
6. Depress clutch.
7. Start the engine.
8. If the tractor has a diesel engine, let it warm up.
9. Check that all gauges are functioning properly.
10. Check operation of clutch, brakes and steering.
11. You are ready to work.

STOPPING THE TRACTOR

After your day's work is done, it's important to follow a correct shut-down procedure. Your pre-operational check will be a lot shorter the next day, and if you find any problems, you can plan your repair schedule with the time and care it deserves. These are the steps you would follow to shut down the engine.

1. Reduce the engine speed to an idle for a few minutes.
2. Set the brakes or put transmission in park.
3. Shut off engine.
4. Perform a quick walk-around inspection.
5. After engine cools down, fill the fuel tank with fuel (especially if a gas tractor).

SUMMARY

BE AWARE in the operation of a tractor.
 BE AWARE of the instruments of a tractor.
 BE AWARE of the controls of a tractor.
 BE AWARE of the limits of a tractor.
 BE AWARE of the areas around a tractor.

BE AWARE!

BE ALERT!

BE SAFE!

BEFORE THE NEXT MEETING

1. Draw a pattern of the gear shift of a tractor.
2. Using an operator's manual as a guide, inspect a tractor's safety features. Note those features missing or not in operating condition. Indicate what action is required to correct the problem.

Safety Feature in Need of Action	Action Required	Date Completed

Tractor Systems

ROLL CALL

Identify one component or part of a tractor.

INTRODUCTION

A tractor is a machine designed to do work. But how is that work done? What makes the tractor move? What makes an engine run? What makes the implement attached go up and down?

The tractor, when viewed as a complete operating unit, is a sophisticated machine (some might say complicated). However, if we break the complete tractor down into smaller and smaller systems or components it becomes easier to review, discuss, and understand how each part works.

Our review of the tractor will divide the systems into two major groups:

1. Those involved with the engine, and
2. Those involved in using the power from the engine.

During this meeting we will first look briefly at all of the systems of a tractor, and then will review in detail those from group 2. Our next meeting will concentrate on the systems that make up an engine.

TRACTOR SYSTEMS

Electrical	- system responsible for the starting of the tractor. Includes the ignition circuit, charging circuit, as well as the lighting circuit.
Fuel	- system responsible for supplying the fuel for mixing with air to be burned in the engine.
Injection	- system for supplying fuel under high pressure at the right time to the cylinders for combustion.
Intake	- system responsible for getting air or air-fuel mixture into the engine for combustion.

- Exhaust - system responsible for getting rid of the waste products left after combustion has taken place in the cylinders of the engine.
- Lubrication - system responsible for supplying oil to, and maintaining lubrication of all moving parts in the engine. Other components of the tractor may also have one of these.
- Cooling - system responsible for maintaining the correct operating temperature of the engine and/or transmission and/or hydraulics. Also used to supply heat to the cab.
- Transmission - system used to supply a variety of ground speeds in both forward and reverse directions. Also includes some method of choosing and changing those speeds.
- Final drive - system of gears which transmit the torque from the transmission to the drive wheels. The last stage in putting all the engine power to work.
- Power take-off - system which permits the transmission of the power produced by the engine to other equipment which can be attached to the tractor.
- Hydraulic - system which provides the "muscle" for controlling various tractor operations. This "muscle" can also be applied to attachments added to the tractor.

POWER TRAIN

The power train of a tractor includes all those mechanical parts directly involved in converting heat energy into mechanical power.

At the beginning of the power train is the engine. It is made up of a number of systems that will be discussed during our next meeting.

The balance of the power train consists of the mechanical linkages used to transmit the power from the engine to the locations where the work is to be done.

TRANSMISSIONS

The transmission performs two jobs:

1. Selects the various speeds at which we drive, and
2. Reverses the direction of travel.

The transmission of today's tractor is one area where major improvements have been and continue to be made in operator convenience and work efficiency. From the first tractors which had only one speed and one direction, there are now numerous types and styles of transmissions in use.

Each of the transmissions listed below has advantages and disadvantages when applied to the tractors on today's farms.

Transmission Type	Advantages	Disadvantages
Sliding Gear <ul style="list-style-type: none"> • spur gears on parallel shafts mesh with each other when slid on shaft • manual clutch required • must stop to change direction or speed 	<ul style="list-style-type: none"> • simple design • very little maintenance required 	<ul style="list-style-type: none"> • noise • large bulky gears • must stop to change
Sliding Collar (constant mesh) <ul style="list-style-type: none"> • gears are in constant mesh • collars are slid on shafts and locked to free turning gears • manual clutch required 	<ul style="list-style-type: none"> • simple design • helical gears are quieter and stronger 	<ul style="list-style-type: none"> • must stop to change
Synchromesh <ul style="list-style-type: none"> • refinement of sliding collar transmission • shifts with clutch when tractor is rolling 	<ul style="list-style-type: none"> • shift on the go 	<ul style="list-style-type: none"> • must use clutch
Power Shift <ul style="list-style-type: none"> • allows shifting on the go without clutching • hydraulic clutch-packs 	<ul style="list-style-type: none"> • shift without clutch 	<ul style="list-style-type: none"> • complicated • expensive
Torque Converter <ul style="list-style-type: none"> • fluid drive, multiplies engine torque • automatically adjusts torque to suit load on drawbar • replaces clutch, often combined with other transmissions 	<ul style="list-style-type: none"> • speed adjusts to load • pulling power adjusts to load 	<ul style="list-style-type: none"> • cannot maintain constant speed
Hydrostatic <ul style="list-style-type: none"> • fluid drive • hydraulic pump driven by engine, supplies oil to hydraulic motor which drives wheels • infinitely adjustable speed • torque automatically adjusts to suit drawbar load 	<ul style="list-style-type: none"> • shift on the go • infinite number of speeds 	<ul style="list-style-type: none"> • not an efficient transmission

DIFFERENTIALS

The differential consists of sets of gears arranged to change the direction of the torque along the drive shaft by 90 degrees and send it out to each rear wheel. The differential gears not only direct the proper amount of torque to each drive wheel, but also allow each wheel to rotate at different speeds for turning corners.

This ability of one wheel to turn at a different speed can cause a problem when one drive wheel has better traction than the other. The wheel with the greater traction may stop turning while allowing the other wheel to turn at double the speed. The pulling ability is limited by the "wasted" power sent to the slipping wheel.

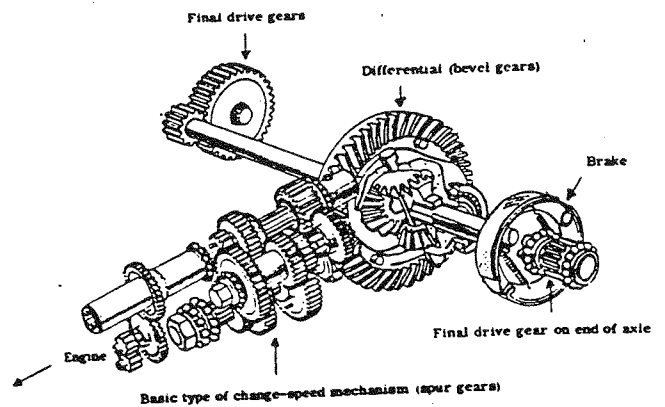

Differential locks are used to prevent this power loss.

FINAL DRIVES

The final drive is the last phase of the power train. Used on most large tractors, they are mounted near the drive wheels, and give the final reduction in speed and increase in torque to the drive wheels. This enables the differential to transmit power at higher speeds and lower torque.

POWER TAKE-OFF

The power train also supplies torque for the power take-off (PTO). This is another point from which work is done. The PTO enables the power developed by the tractor engine to drive mechanical systems of other implements such as balers, harvesters and tillage equipment.

There are three types of PTO's:

1. Transmission-driven - driven off the transmission and run only when the engine clutch is engaged.
2. Continuous-running (live) - have two clutches, one for the transmission and one for the PTO. Both clutches are operated by the same control. The first half of the clutch travel operates the transmission and the second half operates the PTO. This arrangement is called a two-stage clutch.
3. Independent - have their own clutch completely separate from the engine clutch and transmission. In many applications this clutch is a hydraulic clutch pack which allows the engaging and disengaging of the PTO with the tractor in motion.

PTOs on farm tractors run at one of two specific speeds. On tractors up to approximately 80 hp this speed is 540 rpm using a 6 splined shaft, while tractors over 80 hp generally use a 1000 rpm 21 spline PTO.

HYDRAULICS

Hydraulic power is produced on a tractor by pumping oil under high pressure to points where work is done. The hydraulic system provides the "muscles" for controlling various tractor operations. The most common hydraulic functions found on modern tractors involve steering, brakes, transmissions, PTO, remote cylinders, implement control and hydraulic motors. These functions may use a common pump and hydraulic fluid supply, or each may have its own pump and oil reservoir where oil is stored.

The fluid in a hydraulic system serves not only as the power-transmitting medium, but also as the system's lubricant and coolant.

The hydraulic systems on today's tractors have become extremely complex and a full meeting could be spent on these systems. However, an understanding of the basic principles of hydraulics will allow each of us to understand better the systems used on our tractors.

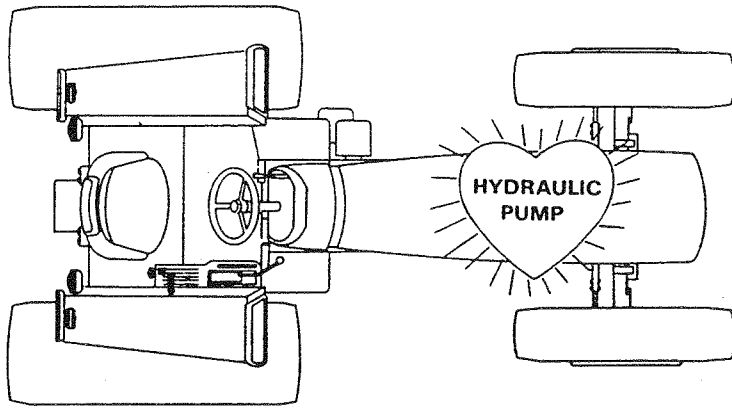

A weight or force of 100 pounds acting on an area of one square inch produces a force of 100 pounds per square inch (psi). This pressure of 100 psi is transmitted equally in all directions throughout the entire system and can be used at any point in the system.

Figure 1

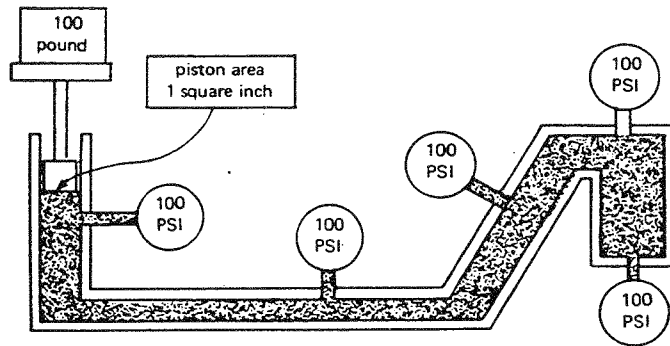

If the pressure of 100 psi is applied to an area of 10 square inches the resulting force pushing against the larger area is $100 \times 10 = 1000$ pounds. Thus, a push force of 100 pounds applied to the 1 inch piston can lift a load of 1000 pounds placed on the larger piston. However, we need to move the small piston 10 inches to get the large piston to move 1 inch. The metric equivalent to PSI is kilo Pascals (kPa). $1 \text{ PSI} = 6.89 \text{ kPa}$.

Figure 2

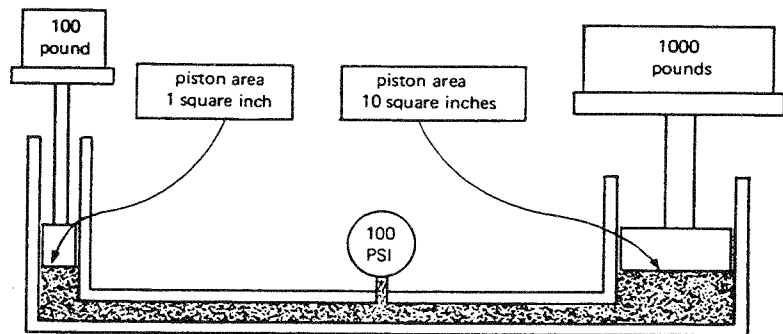

The diagram below, representing a hydraulic jack, now includes all the basic components of a hydraulic system. To prevent the oil from just travelling back and forth between the two cylinders, two check valves are required. These are simply one-way valves that allow the oil to move in one direction only.

When the small piston is pushed down by the hand-operated lever, the oil will push past check valve A and raise the large piston a short distance.

To raise it further, the small piston is raised. Atmospheric pressure in the reservoir will push oil past check valve B to refill the small cylinder and make it ready for a second stroke. During that lifting stroke, check valve A retains the oil already in the large cylinder.

To lower the load, a third valve, C, is opened to allow the oil in the large cylinder to return to the reservoir.

The hydraulic jack is a complete hydraulic system. It has a pump, consisting of the small piston and two check valves, an oil reservoir, and a cylinder to raise the load.

Figure 3

HYDRAULIC JACK

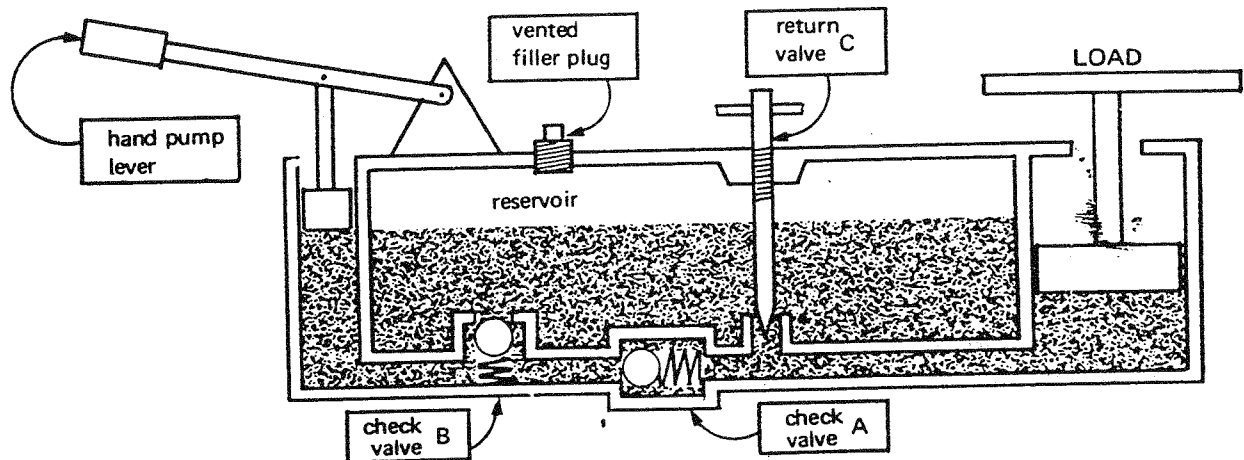

SUMMARY

We have covered a lot of material in this review of the power transmitting systems of a tractor, but we really only scratched the surface as to the how's and why's of these systems. We will look at some of these systems again when we discuss the servicing of tractors at a later meeting.

BEFORE THE NEXT MEETING

Use your operator's manual and manufacturer's specification sheets to determine what type of system a tractor has for each of the following systems.

Transmission - _____

Differential Lock - _____

Final Drive - _____

PTO - _____

Diesel Engines

ROLL CALL

Name one advantage or disadvantage of a gas, diesel or propane engine in a farm tractor.

INTRODUCTION

From its development in 1892, first use in a tractor in 1931, and general acceptance in the early 1950's, the diesel engine now enjoys a virtual monopoly as the power source for the tractors on today's farms.

The diesel engine, like all internal combustion engines, is a device that converts heat energy into mechanical energy to do work. The explosive force produced by the burning of an air-fuel mixture causes the engine piston to move down and by connecting the piston to a crankshaft, the up and down motion of the piston can be converted into rotary motion. The rotary motion can then be used by the other tractor systems discussed earlier to do our work.

It should be noted that except for the differences in fuel delivery systems and the presence of an electrical ignition system on a gasoline engine, the discussions that follow apply equally to diesel, gasoline or propane fuelled engines.

INTAKE AND EXHAUST SYSTEM

The intake system supplies the engine with clean air and the exhaust system carries exhaust gases from the engine. The exhaust system is also responsible for muffling engine noise and directing heat away from the tractor and operator.

A SIMPLIFIED VIEW OF INTAKE AND EXHAUST SYSTEMS.

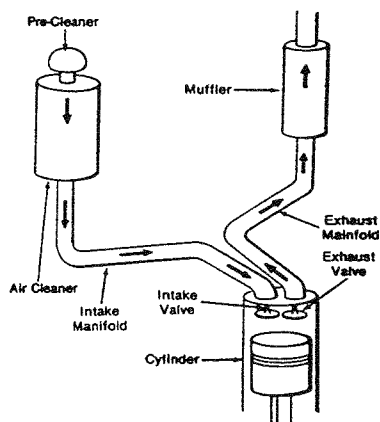

A basic air intake system of a diesel engine consists of an air filtering component, an intake manifold, and intake valves. It may also include components designed to increase the amount of air that can be directed into the engine cylinders, i.e. turbochargers, and intercoolers.

The exhaust system has three basic components: exhaust valves, exhaust manifold, and muffler.

A turbocharger consists of a shaft with a fan-like turbine at each end. The exhaust gases flow by one of these turbines causing it to turn at a very high speed. The turbine on the other end of the shaft then acts as a compressor and forces more air from the intake side into the cylinders. More fuel can then be injected and more horsepower produced.

FUEL SYSTEM

In a diesel fuel system, the diesel fuel is injected (sprayed) directly into the engine cylinder where it is mixed with and ignited by the hot compressed air. This injection and ignition method is the major difference between a gasoline engine and a diesel engine.

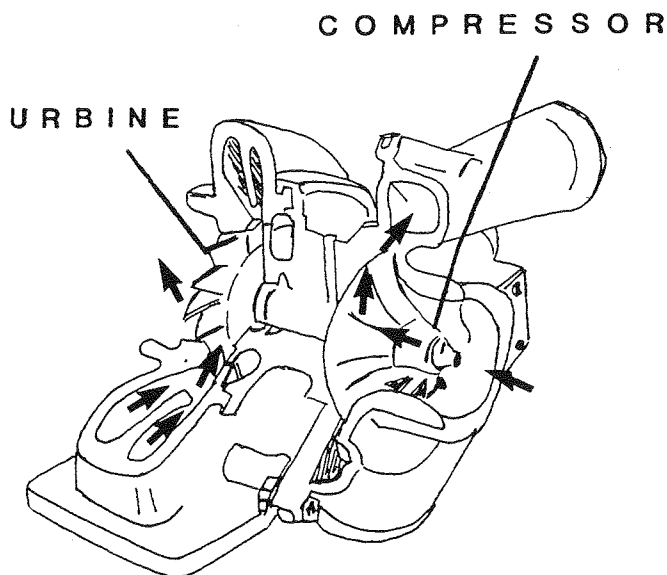

Diesel Fuel System Components	Functions
<ul style="list-style-type: none"> • fuel filters • fuel tank • injection pump • fuel pump • injection nozzles 	<ul style="list-style-type: none"> • helps clean the fuel • stores the fuel • times, measures, and delivers fuel under pressure • moves fuel to injection pump • atomizes and sprays fuel into cylinders

MAIN COMPONENTS OF A DIESEL FUEL SYSTEM (DISTRIBUTOR TYPE SHOWN).

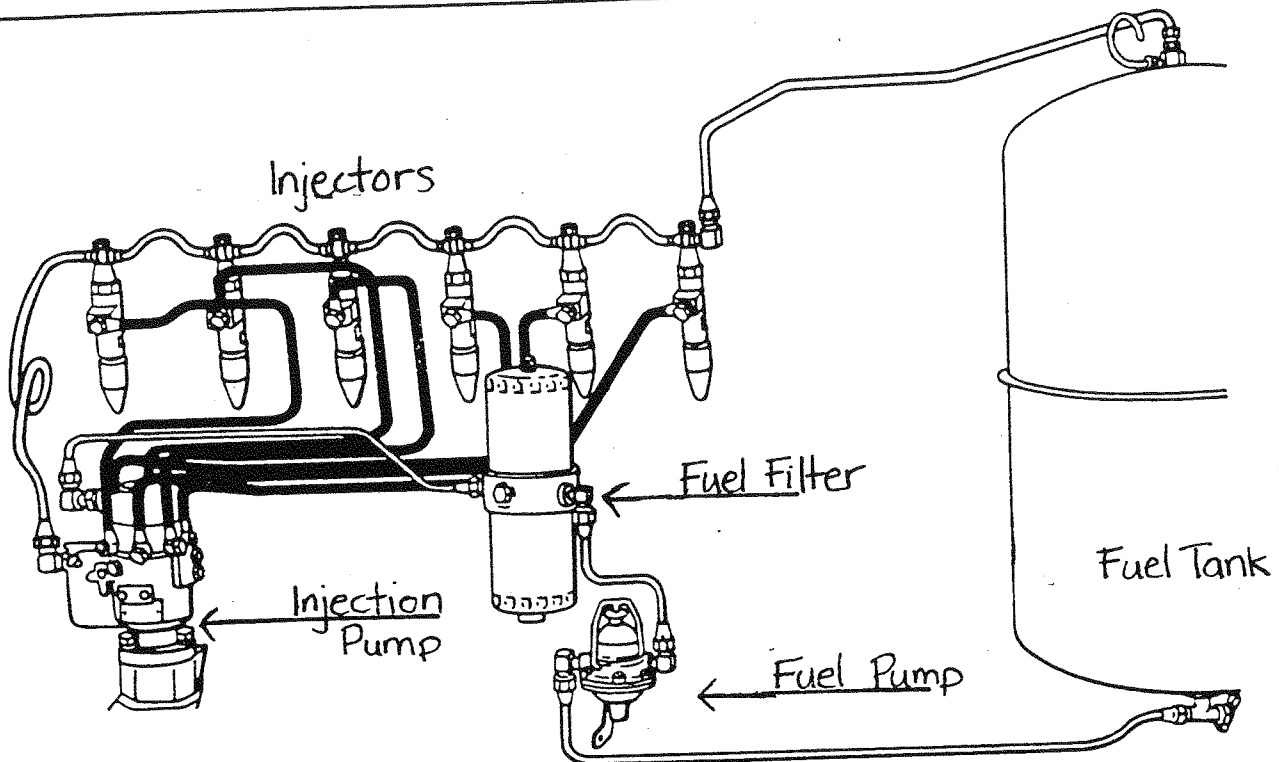

INJECTION SYSTEM

Two of these components, the injection pump and the injection nozzles or injectors are sometimes referred to as the injection system. This injection system is the heart of the diesel engine.

The injection pump is responsible for measuring a precise amount of fuel and then delivering it to the injectors under high pressure. The injectors (one for each cylinder) spray the fuel under controlled pressure into the cylinder at the proper time. The design of the injector tip causes the fuel to be atomized so that the hot air in the cylinder will cause it to burn as soon as it is injected.

Tremendous damage, and high repair costs, will result if proper service and maintenance are not performed on these components. Most importantly, keep the diesel fuel clean and free of water.

COOLING SYSTEM

The internal combustion engine is not a very efficient engine because a large amount of the energy produced by the burning of the air-fuel mixture is turned into heat.

The cooling system prevents the engine from overheating by moving this surplus heat away from the cylinders and the engine. The cooling system serves the second, equally important function of maintaining the engine at the operating temperature required for the best combustion of the air-fuel mixture in varying working conditions. The better the combustion process, the more efficient the engine will be.

Two types of cooling systems are used on today's tractor engines:

1. Air Cooling - uses air passing around the engine to dissipate heat. or
2. Liquid Cooling - uses water around the engine to dissipate heat.

The liquid cooling system for a 4 cylinder engine is shown in the diagram to the right.

The function of each of the components is described below.

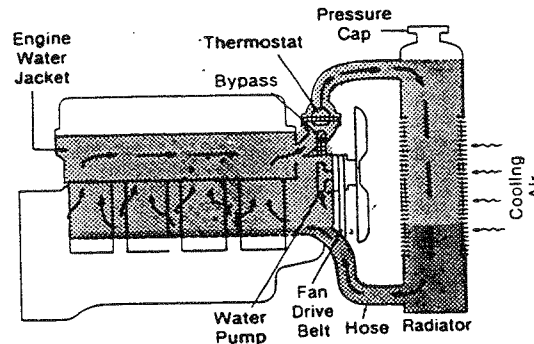

Water Jacket	Both the engine cylinder block and head usually contain passages for coolant to flow around the cylinders and valves. This water jacket keeps the coolant in close proximity to the heat of combustion to collect the heat for transfer to the radiator.
Water Pump	Circulates the coolant between the water jacket and the radiator.
Fan Belt	Delivers power from the engine crankshaft to drive the water pump and the cooling fan. The fan is generally attached to the front of the water pump.
Rad Hose	Connects the radiator to the water jacket. There is an upper and lower hose.
Radiator	Main reservoir for the engine coolant. As the coolant passes through the rad in one direction, and air passes through in a second direction, the heat from the engine is carried by the air into free space. Thus the engine is cooled.
Thermostat	The thermostat controls the amount of coolant allowed to flow from the engine to the radiator, maintaining engine temperature at the correct level.
Bypass	Allows coolant to be circulated by the pump within the water jacket, before the thermostat opens. This circulation allows the engine to heat up to operating temperature quickly but prevents hot spots from damaging specific areas of the engine.

Pressure (Rad) Cap Permits operating the engine at a higher temperature without boiling the coolant. One pound PSI increase will raise the boiling point of water 2°C. Also acts as a safety valve if excessive pressures develop in the cooling system.

Air Cooling is widely used to cool small engines on lawn mowers, motorcycles and most garden tractors. In recent years a few tractor manufacturers have used air cooling for their engines. In the air-cooling process, a very efficient fan forces cool air over the hot surfaces of the engine to help carry off the heat. Specially formed sheets of metal (called shrouds) are often used to help direct cool air to the hottest areas. The surfaces of air-cooled engines are also shaped so that heat can be removed efficiently.

The figure below shows the temperatures found in a typical tractor engine at work. The extremely high temperature at the time of combustion is an indication of the amount of heat that must be removed from this area.

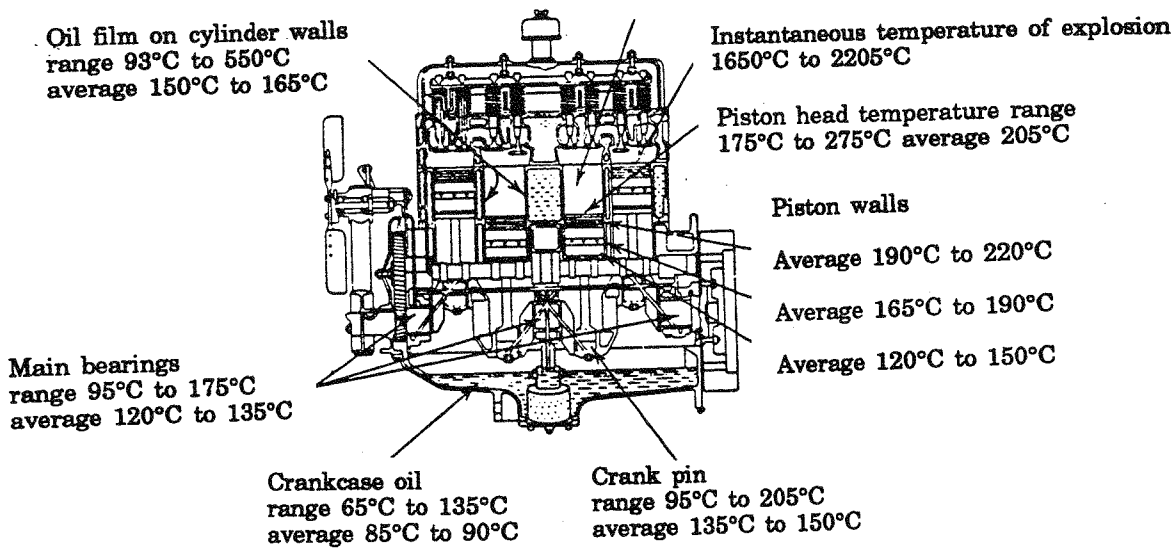

LUBRICATING SYSTEM

Proper lubrication is absolutely essential in an internal combustion engine. It is achieved by circulating under pressure, a suitable oil through passages which are drilled in the engine components. The oil is pumped throughout the engine to the moving parts that need it, and then flows back downward into the oil pan, where it is cooled before recirculation. The pump is situated in the pan and supplies the oil to the engine through a filter. The continuous operation of this system and the cleanliness of the oil are extremely important.

There are 2 major and a number of minor functions fulfilled by the lubricating system.

MAJOR FUNCTIONS

1. To lubricate the moving parts.
2. To cool certain components.

MINOR FUNCTIONS

1. To act as a cushion between moving parts.
2. To prevent leakage of gases past the piston rings.
3. To aid in keeping the engine clean.
4. To prevent corrosion inside the engine.

MAJOR PARTS OF AN ENGINE LUBRICATING SYSTEM.

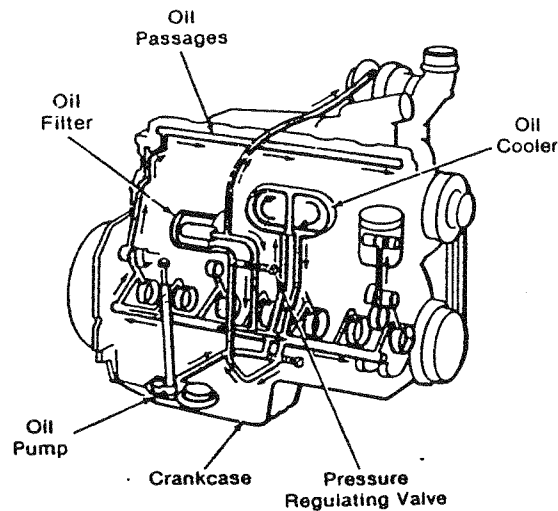

SUMMARY

The diesel engines found in the tractors being used on farms today are as sophisticated as engines being used in any application. This means that anyone involved in operating these tractors should be knowledgeable about their engines. With the basic knowledge of the systems making up a diesel engine, you have taken the first step towards this understanding.

BEFORE THE NEXT MEETING

Visit a tractor dealer or injection system service depot to see some old and worn parts from injection pumps or injectors. Note the precision and quality of construction. If you can, bring some of these parts to the next meeting to show the other members.

Traction

ROLL CALL

What size and type of tires are on a tractor?

INTRODUCTION

It doesn't really make sense to keep a tractor's engine in top condition while at the same time wasting a large amount of this power because of the improper operation of the tractor.

As much as 40% of your engine's horsepower can be lost through the tractor's tire contact with the ground.

Because of this, an understanding of traction (the ability of the tires to transform the power from the drive train into forward motion) is essential. Without traction, all a tractor can do is wear out components and waste fuel. In this meeting, we'll be examining the relationship of traction to such areas as tire construction and design, wheelslip, tractor weighting and inflation pressures.

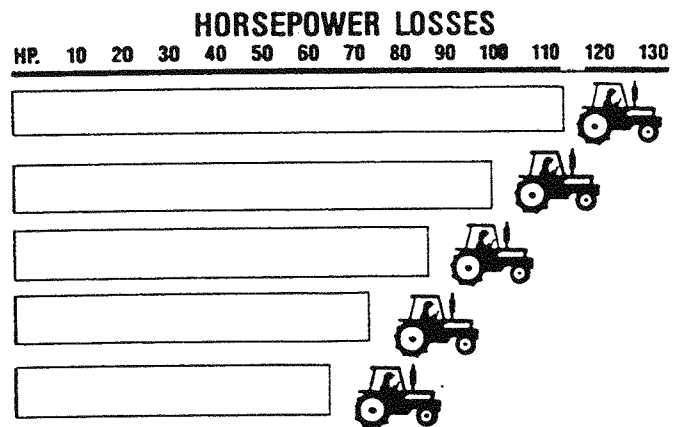

TIRE SIZES

Tire size is indicated by two numbers separated by a hyphen. The first number states the width, in inches, of the tire's cross section. Radial tires have an "R" following this first number. The second number states the diameter, in inches, of the rim the tire should be mounted on, e.g. 18.4-38 is a tire with a cross section width of 18.4 inches and fits a 38 inch diameter rim.

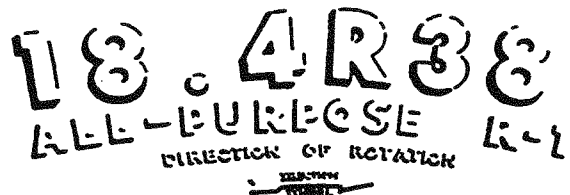

TIRE DIMENSIONS

It's important to keep in mind that the number indicating cross section is not the same as the rim width. The cross section is always wider than the rim.

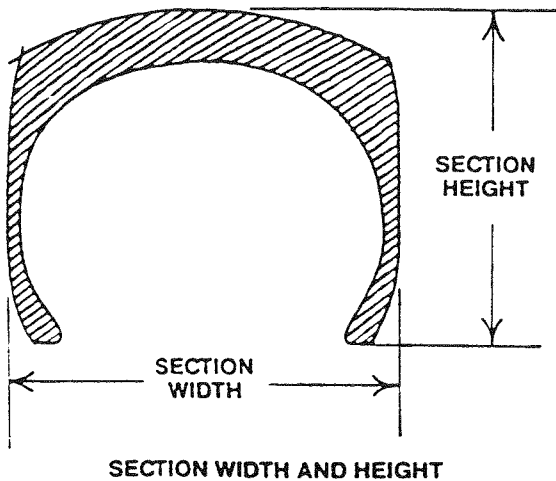

TIRE TYPES

The following is a list of tire types.

- Drive Tires
 - R1 - regular tread
 - R2 - deep rice tread
 - R3 - diamond (turf) tread
 - R4 - industrial tread
- Steering Tires
 - F1 - single rib tread
 - F2D - double rib tread
 - F2T - triple rib tread
 - F2M - multi rib tread
 - F3 - industrial steering
- Implement Tires
 - I1 - rib tread
 - I2 - moderate tread
 - I3 - traction tread
- Other Tires
 - FLO-TRAC - skid steer loader
 - Lawn & Garden Drive tire
 - Lawn & Garden Steer tire

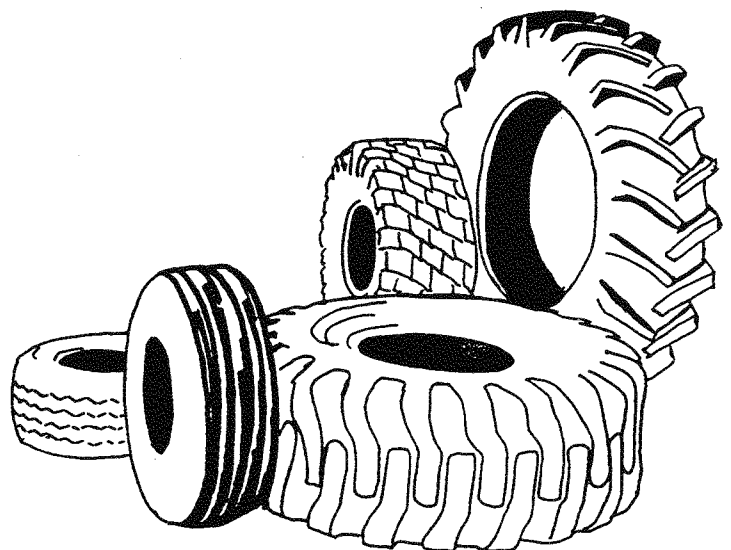
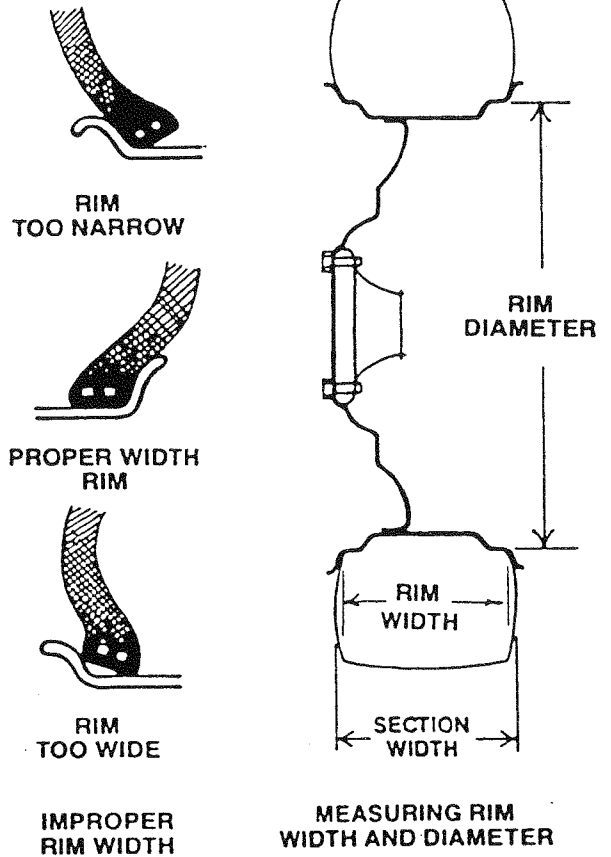

TUBES VS TUBELESS TIRES

You will find both tube and tubeless tires on tractors today. Each type has advantages and disadvantages. Tubeless tires are prone to rim leaks, however, tubes are susceptible to spin damage and to pinch damage.

BIAS PLY VS RADIAL PLY TIRES

Radial tires are rapidly gaining wider acceptance because of their many benefits in flotation, better wear, smoother ride and better traction. However, radials cost more, and require greater attention to maintenance.

DUAL TIRES

A second tire can be mounted side-by-side with the original tire. The second tire can double the amount of tire carrying the load. Duals do supply increased flotation and can carry increased weights. However, recent studies seem to indicate that dual wheels will not improve traction, or at least they improve traction much less than originally expected.

TIRE SELECTION

Here are some of the things you need to consider when choosing tires for your tractor.

- tractor horse power
- tractor weight
- tire footprint
- load to be carried
- will duals be used?
- soil type
- 2WD, 4WD or front wheel assist
- driving speed

WHEELSLIP

Soil type, weight on axles, tire type, number of tires, number of powered axles and inflation pressure - all of these are factors which affect traction. However, there is a key to understanding traction, and that key is wheelslip. Wheelslip is simply the percentage of the tire's motion not converted into forward motion. Knowing how to measure wheelslip, how much wheelslip there should be, and how to control wheelslip is essential if you are going to get the best possible traction, and make the best possible use of a tractor's engine horsepower.

Some wheelslip is required for maximum traction. Slippage allows the tire's lugs to mesh properly with the soil - the looser the soil, the greater the slippage should be.

Another reason for not totally eliminating wheelslip has to do with weighting. If you weighted a tractor enough to eliminate slippage, then too much horsepower would be used just to carry around this weight.

OPTIMUM WHEELSLIP RANGES

Two Wheel Drive

Hard surface	5 - 7%
Stubble	8 - 12%
Tilled soil	10 - 15%
Sand	10 - 20%

Front & Four Wheel Drive

All surfaces	8 - 12%
--------------	---------

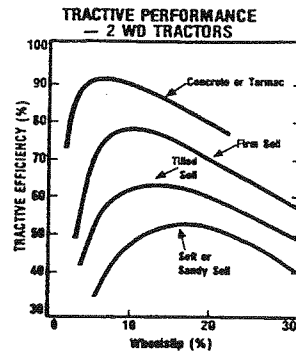

FACTORS AFFECTING WHEELSLIP

Here is a list of some of the some factors that will affect wheelslip.



- soil conditions
- weight distribution
- horsepower
- calcium loading
- load to be pulled or carried
- groundspeed
- tire pressure

WEIGHTING

Weight transfer and distribution

- The type of implement used affects weighting. An implement that is towed by the drawbar will result in less weight transfer from the front axle to the rear axle than mounted or semi-mounted implements. For this reason, weight must be distributed differently for different equipment types.

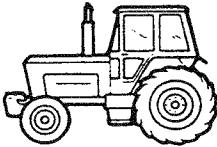
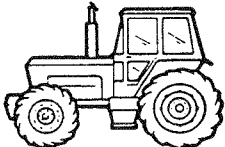
Weight distribution is also affected by the number of axles and how they are powered. Desired weight distribution for two-wheel drive, front-wheel assist and four-wheel drive tractors is shown below.

TWO WHEEL DRIVE IMPLEMENT TYPE	FRONT AXLE	REAR AXLE	
TOWED	25%	75%	
SEMI	33%	67%	
FULLY	40%	60%	
FRONT WHEEL DRIVE	40	60	
FOUR WHEEL DRIVE	60	40	

Weight can be added to the tractor several ways:

- front end weights
- front wheel weights
- rear wheel weights
- add calcium to front and/or rear tires
- weight transfer from attached implement

While it is obvious that more weight will reduce slippage, it's important to keep in mind that weighting should be kept to a minimum whenever possible. At the same time that weight helps control wheelslip, it increases soil compaction and results in accelerated wear of tractor components.

There are several ways that the operating weight of your tractor may be reduced or controlled.

SPEED

- In some cases, one of the simplest ways to reduce slippage without increasing weight is by upshifting the tractor and transforming the horsepower that is spinning the tires into increased speed.
- You may prefer not to increase speed, in which case you'll need to throttle back after upshifting. In either case, guard against lugging the engine.

IMPLEMENT AND TRACTOR SELECTION

- Match tractor and implements on the basis of drawbar horsepower, not PTO horsepower. This means taking the loss of horsepower due to soil conditions into account when selecting an implement.

TIRE SELECTION

- Using tires with a longer footprint can also help increase traction and reduce unnecessary weighting. This may mean choosing a taller, narrower tire over a shorter, wider one.

TIRE INFLATION

The pressure a tractor tire is inflated to is usually a compromise between two competing requirements. On the one hand, pressure must be high enough to support the tractor's weight at a particular speed or the tires will be damaged. On the other hand pressure must be as low as possible to provide traction, or wheel slippage will increase.

When using duals, the outside tire should be at a lower pressure than the inside tire. The inside tire should carry the major portion of the tractor's weight.

The operator's manual and tire guide for your tractor should supply the specific information required to determine the tire pressure for the tire size, weight of tractor and soil conditions you will be working in.

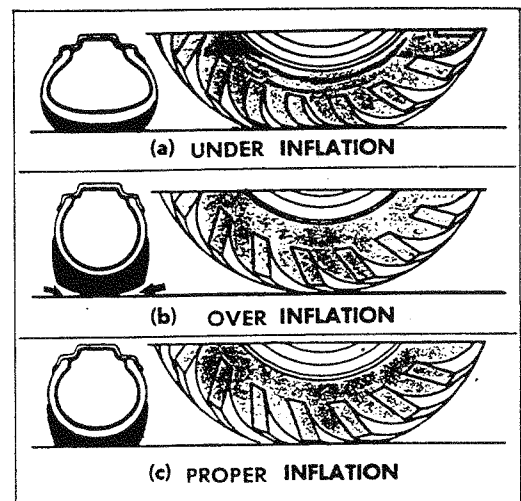

SUMMING UP

Getting the best traction for a tractor is a job that depends on a large number of factors: tire size and type, load, weight, groundspeed and inflation pressure, among others. However, if a tractor is to perform efficiently, it is a job that must be done well.

BEFORE THE NEXT MEETING

Inspect the tires on a tractor. Look at the manufacturer, size, width and the amount of wear. You might want to phone a local tractor tire dealer and inquire about the costs of replacing worn tires.

Maintenance and Service

ROLL CALL

Identify one of the liquids your leader has on display. The listing below will give you some hints.

Gasoline	Stove Oil	Diesel Fuel	Cooking Oil
Water	Engine Oil	Coolant	Hydraulic Oil

INTRODUCTION

Tractors are a major expense for every farm operation. This expense can be divided into two categories:

1. The cost of the original tractor purchase, and
2. The cost of service and maintenance after the purchase.

The second of these costs is one over which we have some direct control. The purpose of preventive maintenance then, is to promote optimum performance and prevent costly repairs while maintaining a safely operating tractor.

Just as engineers at the space centre, pilots at an airport, and truck drivers at a truck stop do a pre-operation check-off, walk-around, or a circle-check before blasting off, taking off, or driving off, so should you as the operator of a tractor. Take a few minutes before starting and getting on with your work, to make sure the tractor is in top working condition.

THE OPERATOR'S MANUAL

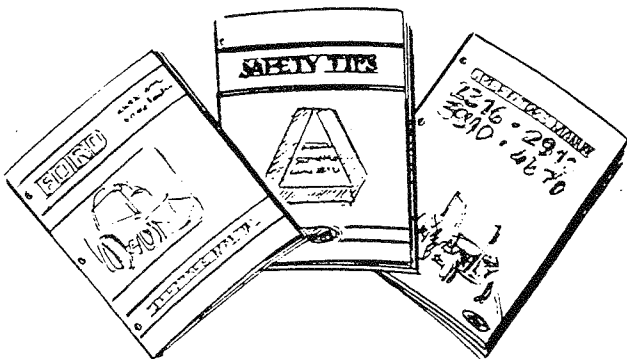

The operator's manual - often neglected, often abused, often forgotten, but still the single most important accessory you get with any farm tractor or piece of farm equipment. Your first duty in properly servicing a tractor is to ensure that you have the proper manual for every tractor you operate. The second step is to read it, and the third is to refer to it often.

CHECKING FLUID LEVELS

There are a number of reservoirs to hold a supply of the fluids used in lubrication, cooling and for the different hydraulic components. It is important to check all these levels on a regular basis. This is sometimes forgotten - we may do such a good job of preventive maintenance that we might be inclined to assume that because there are no leaks and because we change all the fluids as outlined in our manual, we don't need to take the time to check levels. However, it may be one of these checks that would be the first tip to a future problem that identified early enough, becomes a minor tune-up instead of a major overhaul.

LUBRICATING AND GREASING

There are many different types of oils and greases available on the market today, each designed for a specific application. It is important to use only the proper lubricant or grease as recommended by the tractor manufacturer.

Oils and greases have all kinds of different applications. They are used in engines, transmissions, hydraulics, air compressors, on chains, in bearings, on slides, on hinges, etc. Here is a list some of the different characteristics that oils or greases must have to perform the many jobs they do.

- Thin enough to flow
- Thick enough to maintain a layer between contacting parts
- Sticky enough to maintain a layer between contacting parts
- Stick to surfaces without attracting dirt and impurities
- Functional at different temperatures
- Must not react with the parts it comes in contact with
- Must not react with the impurities it collects
- Keep impurities in suspension until removed
- Must not foam when agitated

CHANGING YOUR ENGINE OIL

Engine oils contain a number of additives designed to keep engines in top running condition. These additives are used up as the engine is run. The engine oil must be changed not only to remove the impurities collected by the oil but also to add a new supply of these additives with the fresh oil.

Always change the oil soon after the engine has been run. Dirt and other contaminants are still suspended in the liquid and you can be sure they will drain out with the old oil. After refilling the crankcase and replacing the filter (when required), recheck the oil level. The oil should have time to drain back into the crankcase before its level is checked. Start the tractor and check for any leaks around the drain plug and filter.

The polluting of the environment is becoming an ever increasing problem. Old oil can be recycled by using it to oil chains, hinges, etc. Check local laws regarding the storage of large quantities of oil. Some companies are in the business of picking up oil for recycling. Label the cans containing used oil.

Use the operator's manual to complete the following chart.

Tractor Component	Oil or Grease to be Used	When to Change
Engine Crankcase		
Transmission		
Rear End		
Hydraulics		
Power Steering		
Front Wheel Bearings		

In addition to the specific components listed above, most tractors and equipment require greasing on a regular basis. You will find that when wheels, axles, etc. are still warm from working they will take the grease better than when cold. By getting out the grease gun after a day's work, your greasing (the dirty job) is completed and if repairs or adjustments are required, these can be planned before you need to panic the next morning.

From the operator's manual, record the total number of grease fittings on a tractor. Then break them down to show the number for each service interval.

	Total Grease Fittings	
Service Interval	Daily	

SERVICING THE COOLING SYSTEM

The type of servicing required by the cooling system will be dictated by whether the engine is air cooled or water cooled.

In an air cooled engine, particular attention must be paid to keeping the air flow passages around the engine free of oil and dirt. The shrouding (metal sheets), put in place by the manufacturer is there to direct the air where it is needed and it must be kept intact and in good repair. Like the water cooled engines; belts, thermostats and fans should be inspected regularly.

With today's high horsepower diesel engines, servicing the cooling system on the water-cooled tractor involves more than just adding some water and washing the radiator out with the garden hose. The water of yesterday's tractor engine has been replaced by an engine coolant, formulated to:

- prevent boiling and evaporation in the summer,
- prevent freezing in the winter,
- protect against rust and scaling, and
- protect against cylinder wall pitting.

There are numerous coolants on the market today. The operator's manual will tell you what specific properties the tractor needs and what, if any, additives you may need between coolant changes.

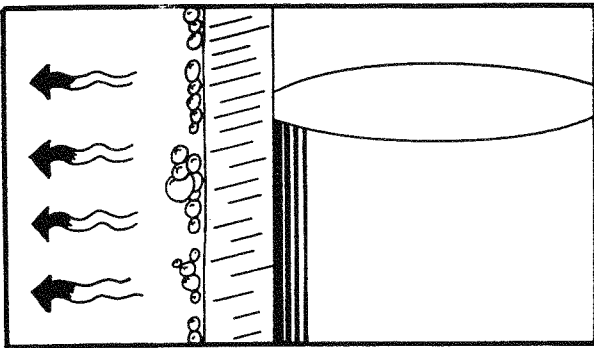

❶ Piston slap creates shock waves that are transferred to the cylinder wall. The resulting vibration creates a partial vacuum, causing vacuum bubbles to form.

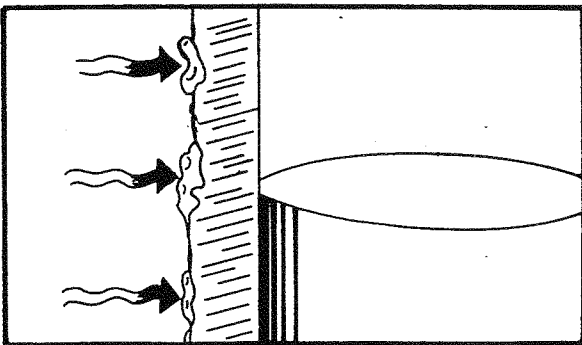

❷ As the coolant rushes back against the cylinder wall, these vacuum bubbles collapse, or "implode."

Cylinder wall pitting is a problem that can happen to any heavy-duty diesel engine. Pitting is caused by piston slap creating vibrations within the cylinder. This vibration forms vacuum bubbles in the coolant which can implode against the cylinder wall, chipping away at the metal surface. This eroded surface, if not protected, may corrode and eventually penetrate through the cylinder wall.

Coolant conditioners are now available, which, when added to the engine's coolant, form a protective film on the cylinder wall, resisting the corrosion and erosion that create pitting.

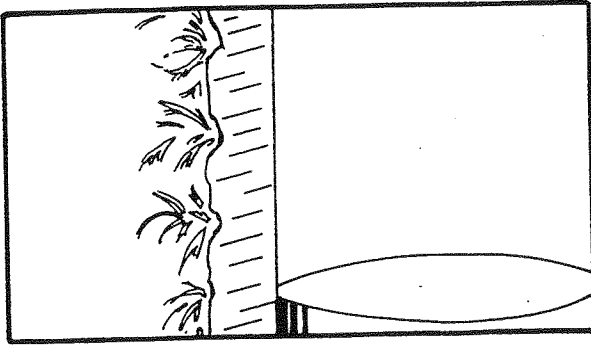

③ This implosion creates such a force that it can chip away or erode the metal surface of the cylinder wall.

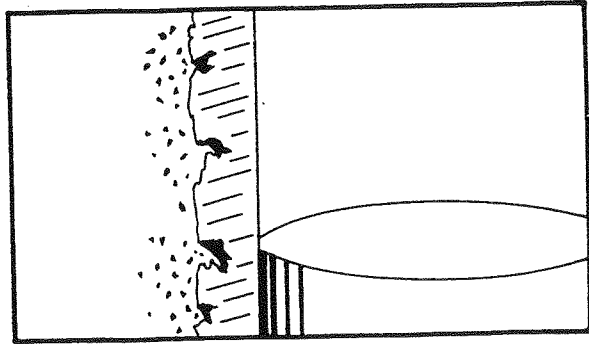

④ This eroded surface can corrode and eventually penetrate through or "pit" the cylinder wall.

SERVICING THE HYDRAULIC SYSTEM

Keep an eye out for oil leaks. Due to the pressure under which hydraulics operate, a small leak today could be oil "blow-out" tomorrow. Not only could damage be done to the tractor if it pumps the hydraulic reservoir dry, but personal injury could result from being hit by a jet of high pressure, hot hydraulic oil.

MAINTAINING THE FUEL SYSTEM

CLEAN FUEL!

CLEAN FUEL!

CLEAN FUEL!

CLEAN FUEL!

Because of the precision with which the injection pump and the injectors are built, any dirt or water in the fuel system can have a devastating effect on the proper functioning of the fuel system. There are several steps we can take to ensure that the fuel is clean, get it to the tractor clean, and send it to the injectors clean.

1. Buy in moderate quantities. A full tank prevents condensation.
2. Buy from a reputable fuel supplier.
3. Store in a clean tank.
4. Tilt tank so water and dirt are away from pump.
5. Install pump at high end of tank. (Water is heavier than fuel.)
6. Clean area around fill cap before removing.
7. Filter fuel into tractor.
8. Fill tractor at end of day (after cooling down) to prevent condensation in fuel tank.
9. Change filters regularly.
10. Drain water and impurities from storage and tractor tanks.

Install your storage container above the ground and tilt the tank so the discharge outlet is on the highest end of the tank. Provide a drain plug at the lowest point of the tank so that moisture and sediment can be drained off periodically. Install a suitable filter on the discharge outlet of the storage container.

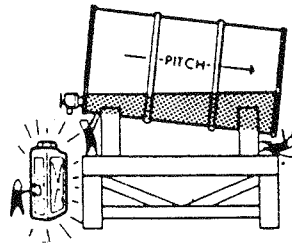
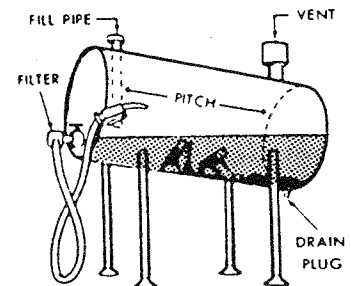

A 50 gallon (41.7 Imp. Gal.) (189.3 L) drum makes a suitable container for diesel fuel, provided that it is tilted on the stand. The drum should be cleaned and flushed before each refiling.

Your tractor operator's manual will advise you how often to change your fuel filter, and any other specific maintenance work required by your tractor.

A CLEAN AIR SUPPLY

Engines require huge amounts of clean air for mixing with fuels to burn during combustion. A diesel engine requires 100,000 gallons of clean air for each gallon of diesel fuel.

Lack of maintenance and service of the air system can greatly increase operating costs in two areas.

1. A dirty filter or any restriction in the airflow will cause a decrease in engine performance. This low performance will require the burning of more fuel to accomplish the same amount of work.
2. A leaking air intake system, which lets dirty air directly into an engine cylinder will cause excessive wear of moving parts. This is one of the major causes of premature engine failure.

The operator's manual will tell when and how to service the tractor's air system. This is one area where the operator must use good judgement. Dirty conditions require more frequent servicing, but under relatively clean conditions, you do not want to open up the filter system more often than necessary. Many new tractors today have restriction indicators with instructions to service the filters only when indicated by these gauges. It is a good idea to write on the air filter the date of change and hours on the tractor.

CHECK THE AIR - SAVE THE TIRES

Adjusting tire air pressure to obtain the best traction is a necessity. There is another equally if not more important reason for maintaining proper tire pressure. The major cause of premature tire wear and failure is improper inflation.

There is no ready answer to the question "How much pressure in the tires?" The answer must come from your operator's manual.

A FINAL LOOK - PRE-OPERATIONAL CHECKLIST

On the next page is a pre-operational checklist, which should be completed daily before you use a tractor. Don't be shocked by the size of the list or the daily requirements. If the pre-operational check is done daily, most of the items will require only a quick look. After you become familiar with your daily checklist, you may want to make the daily list a mental list and produce a more detailed list for a once a month in-depth check up - just like an airplane gets. It will save you money!

PRE-OPERATIONAL CHECKLIST

ITEM	OK	NEEDS WORK	ACTION TAKEN
1. Driving Lights			
2. Indicator Lights			
3. Oil Level & Condition			
4. Hydraulic Fluid Level			
5. Power Str. Fluid Level			
6. Battery Condition			
7. Coolant System			
8. Tire Pressure Front			
9. Tire Pressure Rear			
10. Air Filters			
11. Fuel System Condition			
12. Cab Windows Clean			
13. Seat Belt w/ROPS			
14. Steps Clear and Clean			
15. PTO Shields in Place			
16. Brakes Adjusted			
17. Clutch Adjusted			
18. SMV in Good Condition			
19. NO RIDER" Stickers			
20. First Aid Kit			
21. Fire Extinguisher			
22. Proper Seat Adjustment			

SUMMARY

There are many simple adjustments and regular service items you can do without having to call a service department. All of these items are described in the tractor operator's manual. Learn to follow the instructions in the operator's manual and never assume that everything is working properly unless you know for sure. Major maintenance or overhaul of complicated systems should not be attempted. Remember that proper operation and maintenance will go a long way towards preventing the need for major repairs.

BEFORE THE NEXT MEETING

Complete a pre-operational checklist on a tractor at home, and develop a maintenance schedule for it.

GLOSSARY

- Accident** An unplanned occurrence, frequently caused by carelessness.
- Additive** A substance added to oil or coolant to enhance certain properties. For example, a material added to coolant to inhibit internal rusting of engines.
- Antifreeze** A material added to water to lower its freezing point, such as ethylene glycol alcohol, etc.
- Atomize** To reduce to minute particles or to a fine spray.
- Ballast** Material added to or removed from a tractor to change total weight and traction.
- Bead** Tire plies are tied to strong wire bands in the beads which hold tires to the rim and prevent changes in tire shape or fit on the rim.
- Bias-Ply Tire** Cord plies in bias ply tires extend diagonally (on the bias) from bead to bead and in opposite directions in successive layers or plies resulting in a criss-cross pattern.
- Belted Bias Tire** Diagonal plies in belted tires are surrounded by belts of very low-angle cords under the tread. These belts stiffen the tread thus improving tread life. This type of tire construction is used mainly on passenger vehicles.
- Carburettor** A chamber in which precisely controlled amounts of gasoline or LP-Gas are mixed with air to form a readily combustible fuel mixture.
- Cast Iron Ballast** Cast iron weights attached to tractor front frame, rear and/or front wheels to adjust tractor weight distribution for optimum traction.
- Classification (Tire Code)** Tire identification by type or application: "R" drive tires for tractors, combines, self propelled machines; "F" front or steering wheel tires; "I" implement and wagon tires.
- Combustion** The process of burning.
- Compression** The reduction in volume by squeezing together, as in the "squeezing" of air.
- Compression Ratio** A numerical comparison of the volume of air or fuel mixture in a cylinder before compression and the volume after compression. A ratio of 16 to 1 (16:1) is typical for tractor diesel engines, and an 8:1 ratio is common for gasoline engines.
- Coolant** A liquid circulated through an engine to absorb and release heat. Usually a mixture of water and antifreeze or rust inhibitor.

- Cooling System** The tractor system which maintains the engine at its optimum operating temperature. The cooling system may be a "water cooling" or an "air cooling" system. The cooling system may also help regulate operating temperatures of other systems, such as transmission, hydraulics, etc.
- Deisel** An internal combustion engine in which air is compressed in a cylinder until the air becomes hot enough to spontaneously ignite fuel injected into it. The combustion actuates a piston in the cylinder.
- Differential** An arrangement of several gears which (1) transmit power from the engine to the wheel drive axles, and (2) allows each drive wheel to rotate at a different speed and still propel its own load.
- Dry Ballast** Heavy powdered material pumped into tires for ballast; heavier per unit volume than liquid ballast.
- Electrical System** In a tractor, the electrical energy from a storage battery and/or a generator or alternator is used to crank the engine, ignite the fuel (gasoline or LP-gas) and operate controls, switches, instruments, lights, and warning devices.
- Engine, External Combustion** A machine using energy from an outside source (steam produced in a boiler) to produce mechanical power to do work.
- Engine, Internal Combustion** A machine using energy created by burning a fuel within the engine to produce mechanical power to do work.
- Exhaust System** The tractor system which carries gases, noise and some heat produced during internal combustion away from the engine and the operator's area.
- Filter** A device that removes solid impurities from air, oil or fuel.
- Firing** Combustion of a fuel in a cylinder to actuate a piston. Firing in a spark-ignition engine is controlled by the delivery of the spark through the spark plug. In a diesel engine, firing is controlled by the injection of the raw fuel into the hot compressed air in the cylinder.
- Firing Order** The order in which the numbered cylinders of an engine fire. The firing order for a given engine depends upon its design. The order is written as 1-2-4-3, 1-5-3-6-2-4, etc.
- Flotation** Ability of a tire to support a tractor or machine to resist sinking into the soil upon which it is moving.

Fuel	A combustible substance which when burned releases large amounts of energy. Fuels normally used in tractors are refined petroleum products or natural gases to which are added certain other chemicals used to make the fuel burn more efficiently or to protect engine parts.
Governor Control	A device to control and regulate engine speed. It may be mechanical, hydraulic or electrical.
Horsepower	A measurement used to measure the relative power of a tractor. Horsepower is a measurement of the application of a force over a period of time.
Horsepower – Hour per Gallon	A measurement used to compare the ability of tractors to convert a unit of fuel to horsepower for a period of time. Written as 16.4 hp-hr/gal.
Hydraulic Pressure	Pressure exerted through the medium of a liquid.
Hydraulic System	The system of a tractor in which a pumped liquid is used to do different kinds of work; such as raise and lower implements, shift gears, assist in steering.
Idle	The engine's slowest speed with the machine not in motion.
Inflation Pressure	For air-filled tires, it is the gauge pressure measured with the valve in any position. For tires containing liquid, it is the gauge pressure measured with an air-water gauge and with the valve in the bottom position.
Injection Pump	The part of the fuel system used to meter and deliver fuel under pressure to the engine injectors. An injection pump is always found on a diesel system, and sometimes on gasoline (fuel injected) systems.
Injectors	That part of the fuel system which receives a metered charge of fuel, then injects this charge of fuel into a cylinder or chamber at high pressure and at the proper time. Also called the "injection nozzle". Always part of a diesel system, also found on "fuel injected" gasoline systems.
Intercooler	Sometimes referred to as the aftercooler. A radiator type of assembly sometimes used with a turbocharger on a diesel engine. The intercooler cools hot air leaving the turbocharger so that a greater quantity can be forced into the cylinder for compression and combustion.
Liquid Ballast	Water or water-and-salt solution pumped into tires to improve traction.
Loaded Radius	Vertical distance from centre or axle to supporting surface for a tire inflated to recommended pressure, mounted on normal rim and carrying recommended load.

- Low Section Height Tire** Tire with section height less than 75% of section width. Section height and width of older type tires are approximately equal. Low profile tires can carry 7 - 9% higher load, with 2-4 psi lower inflation pressure, compared with older-style tires having the same section height.
- LP-Gas (Liquified Petroleum Gas)** Made usable as a fuel for internal combustion engines by compressing volatile petroleum bases to liquid form. LP-Gas must be kept under pressure or low temperature in order to remain in liquid form until used by the engine.
- Lubrication** Application of a substance such as a grease or oil to provide a protective film between two surfaces in contact. The lubricant reduces friction, wear, and heat buildup between parts.
- Lug Angle** Angle between centre line of the lug face (tire circumference) and centre line of the lug; ranges from about 20 to more than 45 degrees. Some lugs have multiple angles, others are curved.
- Overinflation** Too much air pressure prevents full contact between tread and ground or road and makes tires more rigid than normal. Results are excessive wear in tread centre and increased damage from striking solid objects such as stones and stumps.
- Ply Rating** An index of tire strength to identify the maximum recommended load for specific types of service. Does not necessarily indicate number of cord plies in the tire as it did in the past.
- Power Takeoff** A mechanical attachment to the power train of a tractor that is used to transmit power to an implement or other auxiliary unit.
- Power Train** The overall system of a clutch, transmission, differential, final drives, and drive wheels which transmits power from the tractor's engine to the drive wheels or output shaft (such as power takeoff).
- Pressure Gauge** A low-pressure gauge with 1-pound graduation is needed for checking rear tractor tires and others with low pressure. Use only an air-water gauge for fluid-filled tires.
- Radial Ply Tire** Tire in which cords of body plies run bead-to-bead at approximately 90 degree angle. Around the tire, between body plies and tread, is a belt of very low angle cords which stiffens the tread.
- Reduced Vibration** Rear tractor tire with shorter intermediate lugs between each pair of standard lugs to reduce vibration.

Rim	Metal support for tires and part of the air chamber in tubeless tires. Tires must match rim width and diameter for safe, satisfactory performance.
Rim Diameter	Diameter at intersection of bead seat and vertical portion of rim flange. Always measure rim diameter when replacing tires; standard tires won't fit some odd-sized imported rims.
Rim Width	Distance between vertical portions of rim flange. Tire beads will not seat properly if rim is too wide or too narrow.
Rolling Resistance	Power lost moving equipment. Increases in softer soils and as weight increases. Includes energy to push unpowered front or implement wheels against a wall of soil and to compact loose soil under wheels.
Rubber Manufacturer's Association	A rubber industry group concerned with tire requirements other than tire dimensions, loads and inflation pressures.
Section Height	Height of a new tire measured from nominal rim diameter to centre of tread surface after the tire has been inflated.
Section Width	Width of a new tire from sidewall to sidewall after it has been inflated 24 hours, but not including protective ribs, bars or decorations on tire sides. This is not the same as rim width.
Sidewall	Rubber coverings on both sides of the tire body designed to bend and flex without cracking during ordinary deflection and under reasonable shock loads. Proper inflation extends sidewall life and life of the tire.
Slip	Relative movement between the tires and the surface on which they are operating, usually expressed in percent. May be called travel reduction.
Sludge	A pasty substance formed from the mixture of petroleum products, oil and water. It clogs oil lines and interferes with engine lubrication.
Soil Compaction	Reduction in soil volume caused by wheel traffic, action of tillage tools or other equipment, or heavy precipitation.
Star Marking	New load rating system for radial tires. More stars mean higher load and inflation capacity for a given size tire. Star markings are for radial tires only and replace the ply rating system, which will still be used for bias-ply tires.
Stroke	The measurement of maximum piston travel between top dead centre and bottom dead centre.

Tangential Pull	Maximum recommended pull per tire at a given load and inflation pressure. Originally given as percentage of static load for each tire size.
Tire And Rim Association	An organization of tire and rim manufacturers which develops standards for tire dimensions, such as loads and inflation pressures, to permit easier selection and interchange of tires and rims made by different manufacturers.
Tire Dimensions	Size marking of 18.4-38 indicates section width of 18.4 inches and 38 inch rim diameter. Marking of 18.4R-38 indicates a radial tire. Required rim width of 16 inches appears below tire size.
Torque	The effort of twisting or turning. A combination of forces used to produce motion.
Traction	Net force in direction of travel developed by a vehicle. Commonly considered to be the grip or friction between powered wheels or tracks and the surface on which they are operating. Depends on vehicle weight, travel speed, tire inflation pressure, surface type and condition and other factors.
Tractive Efficiency	The ratio of output power at the hitch or drawbar to input power to the wheels. Losses involve wheel slip and rolling resistance.
Transfer Pump	The fuel pump used to deliver fuel from the tractor fuel tank to the injection pump. Sometimes called a charge pump.
Tread	Lugs, bars or other patterns on the tire face to grip the soil or other surface on which tires are operated. Different tread patterns and depths are proved for different conditions.
Troubleshooting	A process of diagnosing the source of the trouble through observation and testing.
Tubeless Tire	Tubeless tires have no inner tube and are generally easier to maintain than tube-type tires. Proper inflation helps prevent possible unseating of beads on steering tires on hard turns and from drive wheels when high torque is applied.
Turbocharging	A turbine unit powered by exhaust gases from the engine which compresses fresh air, allowing more air to be supplied to an engine so additional power can be developed.

Underinflation

Inadequate inflation pressure causes premature replacement of more tires than any other cause. A particular hazard with liquid-filled tires because of relatively small volume of air, and any air loss results in much greater decrease in pressure than when tires are inflated with air alone.

Valve

Snap-in or clamp-in valves may be used with tubeless tires and should be replaced whenever tires are replaced. Valves in inner tubes may be sheared off if underinflated tires slip on the rim during heavy pulling.



Global Positioning Systems

Farm Machinery Meeting Supplement

4-H Ontario

**Meeting Material for Members
and Leaders**

December 2007

4H
Ontario



THE 4-H PLEDGE

"I pledge:
My Head to clearer thinking
My Heart to greater loyalty
My Hands to larger service
My Health to better living
For my club, my community and my country."

THE 4-H MOTTO

LEARN TO DO BY DOING

VISION FOR 4-H ONTARIO

We will be recognized for delivering quality, innovative, and sustainable leadership and life skill programs for youth and volunteers; which will benefit the citizens and communities in which they live.

VOLUNTEER STATEMENT

4-H Ontario volunteers are passionate and dedicated individuals essential to the delivery and success of the Ontario 4-H program.

PROVINCIAL 4-H OFFICE

5653 Hwy 6 N, RR 5
Guelph, ON N1H 6J2
1-877-410-6748
PH: 519-824-0101
FX: 519-824-8759
Email: inquires@4-hontario.ca



WEBSITE

www.4-hontario.ca

Compiled by Sarah Judd, August 2007.

4-H Ontario is not responsible for the content of any of the web sites or documents linked here and does not necessarily endorse or support the views expressed within them. 4-H Ontario cannot guarantee that these links will work all of the time and has no control over the availability of these sites. We welcome suggestions for further links to be added to this section.

This supplement was sponsored by:
The Syngenta Agricultural Futures Program



Leader's Information: GPS and Its Role in Agriculture

Possible Roll Calls:

- What is a practical current or future use of GPS in our society?
- Do you or anyone you know use GPS systems in their life currently? If so, how? (E.g. car tracker maps, etc.)
- Name an advantage or a disadvantage of using GPS in agriculture.
- Use the activity listed on the next page and figure out your longitude and latitude for next meeting (their longitude and latitude should be the roll call answer).

This supplement has been formatted so that leaders can pick and choose from the activities and resources provided to suit the needs of their group. Pages marked with the  icon are formatted as handouts for members.

Activities

1. Find out the longitude and latitude of your house!

You'll need the internet for this activity. Log on to www.maps.google.com and type in your address. When your location comes up in the map box, click on "link to this page" in the top right corner. A web address will come up already highlighted, copy and paste it into an application so that you can clearly see the whole thing. You only need one section of it, labeled 'll'. For example, the CN Tower:

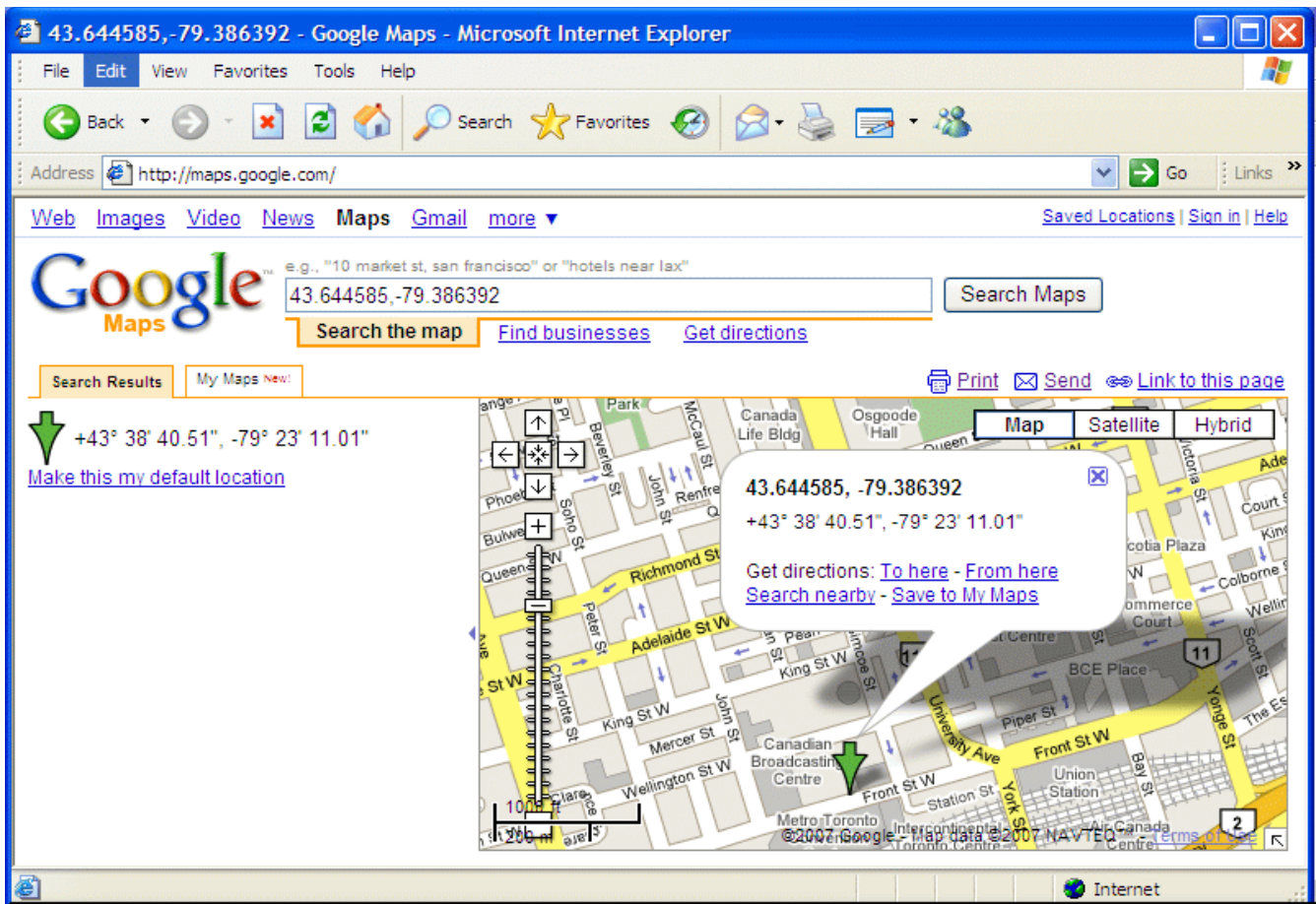

This is the link that comes up:

<http://maps.google.com/maps?f=q&hl=en&geocode=&q=CN+Tower&ie=UTF8&ll=43.645579,-79.387293&spn=0.008851,0.0212&z=15&iwloc=addr&om=0>

The 'll' is 43.645579, -79.387293.

Put only those numbers, just as they are, back into the search at maps.google.com. The same location should come up, with the converted values for longitude and latitude.

The new longitude and latitude would be read **N43 38' 41"** (North because positive; South would be negative) **W79 23' 11 "** (West because negative; East would be positive)

Maps from www.maps.google.com

Activity courtesy of http://www.askdavetaylor.com/figure_out_latitude_and_longitude.html

Other Activity Suggestions:

2. **Contact** a high-tech local farmer and have them speak to your group about GPS on their farm and why they chose to go that route. Contact a dealership to see if someone can talk to your group about GPS systems and their relationship with different types of machinery available.

3. **Map your own Backyard** (You will need measuring tools)

Have members measure out their yards and put it on a grid, where each square represents an appropriate scale. Using correct spacing and size, draw in other backyard items as well, i.e. doghouse, barbecue, patio table etc. OR have members all map out the same area in groups or teams and compare maps after with a discussion of why they could look different, etc.

2. **Mock GPS Setup** (You will need multiple balls of different coloured string, scissors, stickers)

In a clear room, place 3 items to be "satellites" that cannot move, perhaps a light switch, floorboard, point on a window, etc. Make sure you designate a *single point* from which to measure from. Get members to work in groups of three. One member stays out of the room, while one member is the "object" and the other is the measurer. Give each group three different colours of string, long enough to reach anywhere in the room from a designated spot. The 'object' person stands anywhere in the room and does not move from this spot.

Facing the first 'satellite', the measurer should take the first colour of string and measure a length from there to the 'object's' feet, and cut the string. Be sure to remember which colour of string goes with which satellite. Repeat this with the other two satellites until you have a length of string from each that goes directly to your object's feet. The object then places a small sticker (All groups should have a different one) in the place where they were standing; it is the third member's job to figure out which sticker belongs to their group.

Call the third person back into the room. Using only the strings, and the 'measurer' for extra hands (no hints, please) the third person can work backwards to trace where their teammate was previously standing.

Once all groups have correctly found their corresponding sticker, you can demonstrate how a building can throw off result readings; gently pull down on one of the strings and see how the location moves.

Additional Internet Resources

- **<http://www.farmsmart.ca>** - this site has many videos available for borrowing, as well as factsheets and games.
- **<http://worldofagriculture.org/WOA-precag.htm>** - this site has links to dozens of sites focusing on precision farming.
- **<http://www.murraystate.edu/agr/RegionalFFA/AITC/AITCmain.html>** - this site features more activities for younger children to do with GPS and farming.
- **http://www.space.com/php/video/player.php?video_id=b010515_sp_harvesting** - a short online video introducing GPS in agriculture.
- **<http://spacegrant.montana.edu/borealis/classroom/gps1.php>**—Borealis Space Grant Consortium High Altitude Balloon Program. This website features several in-depth activities relating to Global Positioning Systems.

GPS - History and Introduction

GPS, or Global Positioning System, was developed by the United States Department of Defense to be used by their military. Now, the applications of GPS extend far and wide into all different areas. It is made up of 24 satellites, orbiting the Earth. These satellites send signals down to receivers; from that your precise location is calculated.

Other facts about GPS

- The more satellites available that the receiver can "see", the more accurate the reading.
- A receiver needs *at least* three satellite readings before it can calculate your position.
- Satellites orbit at about 18000 km above the Earth's surface.
- Each satellite's path is monitored by ground stations here on Earth.
- As a rule of thumb, if an object can block the sun it can get in the way of a GPS signal
- It is used for surveying, mapping, navigation, vehicle tracking, precision farming, and more.

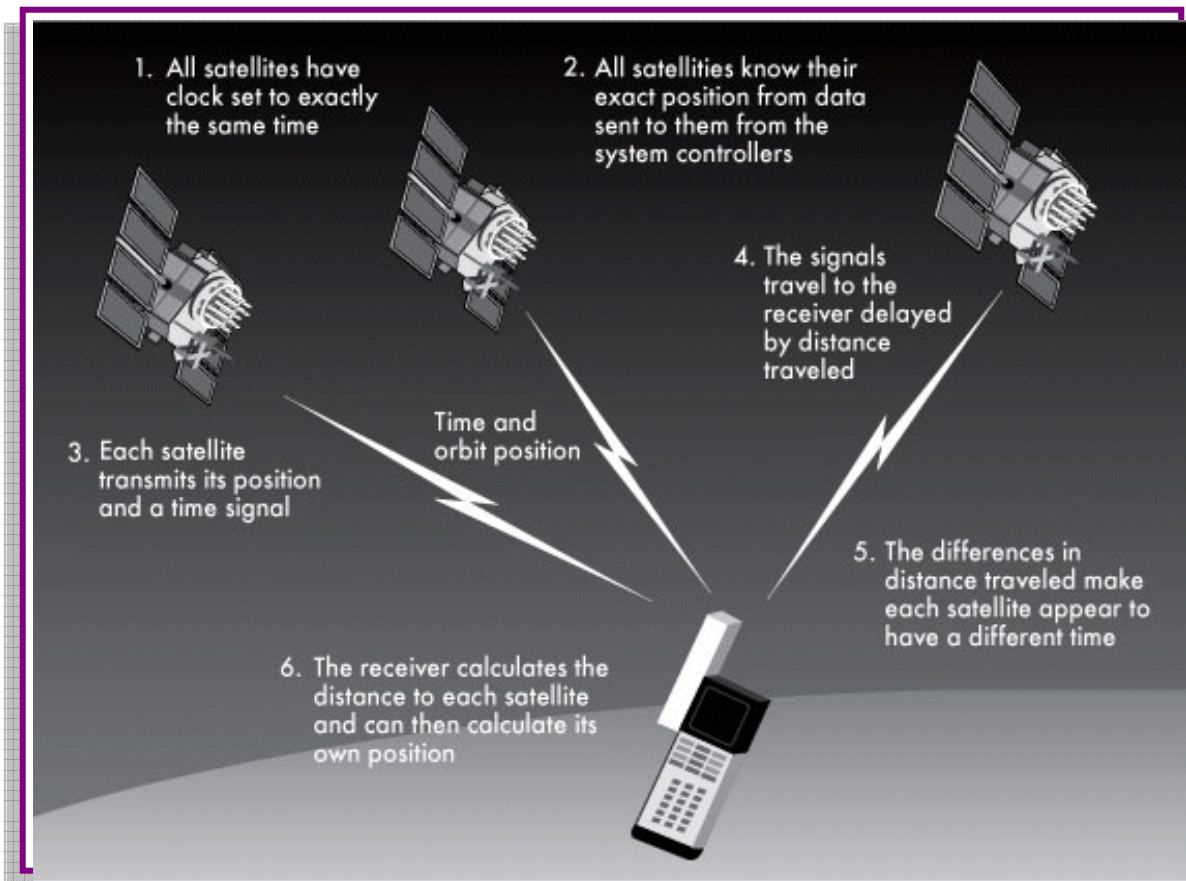

Source - <http://www.aero.org/education/primers/gps/howgpsworks.html>



Differential GPS

The average GPS reading depends on many variables, such as weather and urban structures. Usually it is accurate to within 15 metres, but for farming this is not good enough.

Differential GPS, or DGPS, involves a reference station sending a correction signal to the receiver as well. This correction signal can make the reading, in optimal conditions, accurate within centimetres, suitable for farming.

Source - <http://www.environmental-studies.de/GPS/GPS-tracking-systems/GPS-car-tracking-systems/Car-tracking-9/car-tracking-9.html>

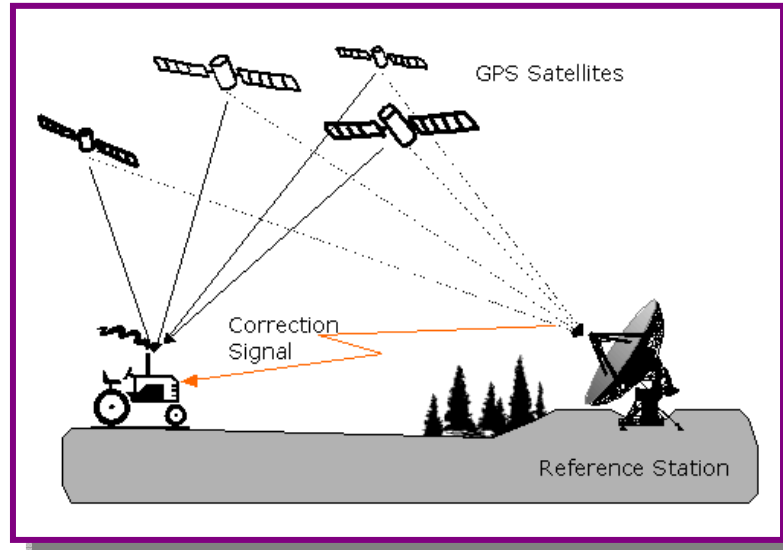

Advantages of Using GPS in Farming

- Using GPS tracking, row overlap when planting, spraying, or fertilizing can be eliminated, which saves resources, time, money, and is better for the environment.
- In both visual and automated guidance systems, the operator has a much more accurate view of the field they are working in; they can also work in conditions that would otherwise not be operational, such as nighttime, heavy fog, or heavy dust.
- A single driver, with automated systems, could operate multiple pieces of machinery at once.
- Scouting fields with a GPS monitor can help pinpoint problem areas, and the farmer will know exactly where to return when the issue has to be solved, e.g. weed monitoring, salinity, pest infestations.
- Site-variable factors can be mapped using GPS which provides the farmer with additional information about his or her fields, for example yield and soil mapping.
- Overall, the farmer has a much greater knowledge about their land and how best to manage it.



Disadvantages of Using GPS in Farming

- High initial start-up cost - systems can be very expensive
- Time commitment - the farmer has to be willing to learn all about the new technology they are using
- A backup must be in place in case of system failure, power failures must also be considered.
- Cost vs. returns - for certain operations, using GPS equipment systems will not be profitable

