



4-H Publication #750
Version 04/02

B.C. 4-H Goat Members Manual



Acknowledgements:

This manual is produced for 4-H members and leaders enrolled in the 4-H programs administered by:

The British Columbia 4-H Provincial Council
in partnership with the
B.C. Ministry of Agriculture, Food & Fisheries

Information for this manual has been drawn from several sources, including Canadian and American goat reference materials. Thank you to the Ontario 4-H Council and Nova Scotia Department of Agriculture and Marketing for the use of their goat materials in the revision of the B.C. 4-H goat project materials. A special thanks to Allison Watt of the Okanagan North Goat 4-H Club for her excellent work on the pack goat unit materials and to the BC 4-H goat leaders and members for your input and patience during the revisions of the BC 4-H Goat Project.

Front Cover Clipart by Sue Estrada.

*This 4-H Manual belongs to _____
of the*

(please print - member's name)

Club.

Mailing address



4-H Motto

Learn to do by doing.

4-H Pledge

I pledge
My Head to clearer thinking,
My Heart to greater loyalty,
My Hands to larger service,
My Health to better living,
For my club, my community and my country.

4-H Grace

(Tune of Auld Lang Syne)

We thank thee, Lord, for blessing great
On this, our own fair land.
Teach us to serve thee joyfully,
With head, heart, health and hand.

TABLE OF CONTENTS

Goat Members Manual

4-H Goat Project Outline	1
Record Keeping	1
Selecting a Goat	2
Breeds of Goats	3
What to Look for in a Goat	7
Selecting Your Goat	7
Building Your Goat Herd	8
Breeding	9
Kidding	11
Tattooing	13
Dehorning or Disbudding	14
Milking	15
Other Goat Products	21
Nutrition	22
What is a Ruminant	24
Classes of Feed	26
Great Outdoors	27
Alternate Feeds for Goats	29
Calcium, Phosphorous and Other Minerals & Vitamins are Important	29
Feeding Guidelines for Goats	32
Housing	39
Types of Housing	39
Feeders and Waterers	42
Health & Diseases	45
Goat Health Signs	48
Common Diseases of Goats	50
How to Give an Injection	56
Fitting and Showing Your Goat	58
Clipping a Goat	59
Getting Ready	60
Goat Judging	68
Dairy Goat Judging Terms	76
Meat Goat Judging	79
Pack Goat Judging	86

Pack Goat	87
Introduction to Goat Packing	87
On the Trail	88
Caring for Your Packer	91
At the Fair	93
Glossary	<i>i</i>

4-H GOAT MANUAL

Are you ready to learn more about goats? Whether you raise meat goats, dairy goats, or pygmy goats or any other type of goats, this 4-H goat manual is for you. Through activities in the goat unit work, you will have many interesting and exciting challenges. You'll learn about goat parts, breeds, and cost of raising a goat, how to care for your goat and much, much more. If you don't already have a goat, some of the activities in Unit 1, the Beginner Goat will help you decide whether or not you want to take goats as a 4-H project.

Learning about goats isn't all you will be doing. You'll also be learning about yourself. In addition to learning about goats many of the things you'll learn are skills you'll use in other areas of your life such as decision making, and communicating with others.

4-H GOAT PROJECT OUTLINE

The requirements for the Goat Club member are outlined in the Dairy Goat Project Regulations, 4-H Publication #702. New members are encouraged to continue with 4-H club work, maintaining the Female Kid project for a second year as a Yearling project as well as building up a Milking Doe project within three to four years. Other units are available in the goat project if a 4-H member does not wish to have a dairy goat project.

The animal must be the property of you the member or your parent or if by other arrangement, using the 4-H Livestock Lease, 4-H Publication #140(E).

New members should secure advice from their Club leader, or local goat breeder in selecting a project animal. It takes years of experience to be able to select with accuracy and that is one of the things, which the 4-H Club hopes to teach you. At the outset, however, if you are a new member, seek the advice of an expert.

RECORD KEEPING

Record keeping is a very important part of the training in 4-H Club work. Records should be kept accurately, neatly, and continuously. Record Keeping disciplines a person and provides a valuable store of information for anyone will to take pride his or her efforts.

Livestock record books are available from the 4-H supply service. These record books have the basics of sound record keeping, but can be enhanced by your 4-H Club to better reflect your 4-H Goat project. Records should indicate health, feeding regimens, and growth, project income, expenses and any other records that show what your goat project is all about. The better records you keep, the better you will know how to take care of your goat.

If properly completed, your Record Book will tell the complete story of your goat. How much it weighed, where you bought it, what it cost. It will show how much feed of different kinds that it consumed. Enter the figures and remarks in your record book promptly before you forget.

Record keeping is becoming increasingly important to the farm operator today and a thorough understanding of the basic fundamentals will be tremendous asset in the future.



SELECTING A GOAT

There is no “best breed”. Good goat breeders have success with any breed of goat. What kind of goat do you want? Equally important, what kind of goat will match your needs? How will you decide? There are many different kinds of goats and goat projects. One way to decide is to learn about types of goats available in your area.

Breeds of Goats

Wild goats were first domesticated in Western Asia thousands of years ago and used mainly for food, first meat and later for milk and cheese. Their skins were also used for clothing, bedding and to make tents. Their wool and hair were gathered and spun and woven into cloth to make clothing.

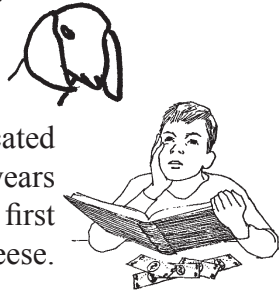

Today goats are most popular in countries with warm climates such as Greece, Turkey and India. Goats are raised in Africa, Mexico, Brazil, Spain and even China, too. Today's goats have been selectively bred to produce more milk, more meat or more fibre.

Choosing the Right Goat

Many tools are available to help us make a wise choice when we are looking for a new goat or picking one for our project.

Pedigree:

Goat can be “Pure-breds”, “Canadian”, “Recorded Grades” or “Grades” of each breed. A “Grade” goat is a goat that looks like a certain breed or a mixture of two breeds. It does not have registration papers of any kind. A “Pure-bred” goat is a goat that has registration papers and is a “pure-bred” of its breed. A “Canadian” of a breed is a goat that is at least 7/8 parts pure-bred of any of the recognised breeds. It also has a registration paper. A “Recorded Grade” is a goat that is either ½ or ¾ parts pure-bred. It also has a registration paper. All goats with registration or recordation

papers must be tattooed legibly with a tattoo that matches the goat's papers.

The goat will be tattooed in its right ear with the registered herd letters of the farm where it was born. The goat's left ear will have an identifying number and the letter designated for the year that it was born. (i.e. All goats born in 2002 would have an “M” tattooed in their left ear.)



Ontario 4-H Council

If you are buying a goat that is supposed to be “Pure-bred”, “Canadian” or a “Recorded Grade”, you should expect to receive registration papers with the animal. The tattoos on the goat should match the numbers on the papers. The seller is responsible for sending the registration papers to the Canadian National Livestock Records, Ottawa, to be transferred into your name. This should take 4 to 6 weeks.

A goat's registration paper is a permanent record of its family history. Using these records and developing an extended pedigree, you can see if there are any proven sires and dams in a goat's family. Proven animals are those that passes on qualities such as high butterfat and milk production in a dairy animal or a finer, more lustrous hair in an Angora. Many desirable traits or qualities can be traced through registration papers.

Remember that your 4-H project goat does not need to be a registered goat. For your 4-H project, you should choose a female goat or a castrated (neutered) male goat – check with your leader. Bucks become very large and strong and give off a strong musk odour during the fall and winter seasons and are not allowed as 4-H project animals in the BC 4-H program for child safety reasons.

Your goat may be a grade or a purebred. In either case, the sire will be purebred. It is much better to

have a good grade than a poor purebred. There is often an advantage in starting with a registered goat. However, don't select a kid just because it is registered. Registration papers do not guarantee that she will be the kind of doe you want to milk in the herd.

Breeds of Goats

There are over 100 goat breeds in the world, ranging in size from the 9 - 18 kilogram tropical breeds to breeds of European and African decent weighing 45 kilograms and more. Check with specific breed registries for the breed standards of weight and height.

Dairy Breeds

Six dairy breeds are recognised in Canada: Alpine, Saanen, Toggenburg and Oberhasli are European in origin, and are collectively known as the "Swiss" breeds. The Nubian breed was developed from African and Indian goats bred to European dairy breeds in England, and were initially called the Anglo-Nubian. The LaMancha was bred from short-eared goats observed in southern North America and is now a well-recognised dairy breed on this continent.

Toggenburg

The Toggenburg, a native of the Toggenburg Valley of Switzerland, resemble a deer in colour and markings. The breed has been a recognised purebred breed in Canada since 1917. This breed is medium size, sturdy, vigorous and alert in appearance. The hair is short to long in length, soft and fine. Its colour is solid varying from light fawn to dark chocolate with no preference to shade.

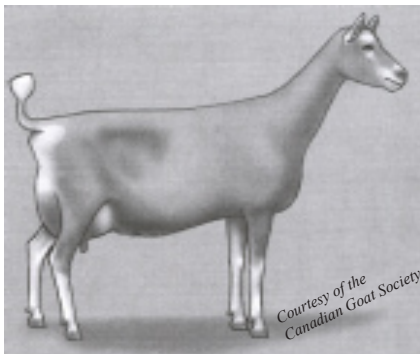

Distinct white markings are as follows: white ears with dark spot in the middle; two white stripes down the face from above each eye to the muzzle; hind legs white from hocks to hooves; forelegs white from knees downward with a dark vertical stripe below knee acceptable; a white triangle on each side of tail; white spot may be present at root of wattles or in that area if no wattles are present. Varying degrees of cream markings instead of pure white are acceptable, but not desirable. The ears are erect and carried forward. Facial lines may be dished or straight, never Roman. Good does will produce 4.5 to 6.6 litres of milk per day. A recorded weight of Toggenburg does average 40-45 kg while 60 - 65 kg may be considered an average weight for males. On official testing, does of this breed produced an average of 915 litres of milk during a 305 day lactation.

Saanen

The Saanen is named after its place of origin in Switzerland. Purebred Saanens were one of the first breeds imported to North America from Switzerland, and was found to be productive, cold resistant and docile. It is medium to large in size with rugged bone and plenty of vigour. Does should be feminine, however, and not coarse. A Saanen is white or light cream in colour, with white preferred. Spots on the skin are not discriminated against. Small spots of colour on the hair are allowable, but not desirable. The hair should be short and fine, although a fringe over the spine and thighs is often present. Ears should be erect and alertly carried, preferably pointing forward. The face should be straight or dished. A tendency toward a Roman nose is discriminated against.

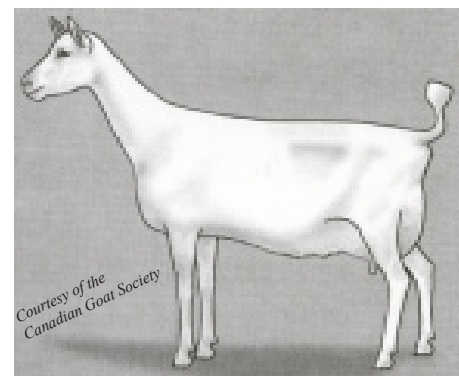

Mature Saanen females in good flesh will average 55 kg and males 84 kg in body weight. The Saanen is a good milker. Does of this breed average 915 kilograms of milk during a 305 day lactation. At the peak of production a good doe will give 5.7 to 8.0 litres per day.

Nubian

The Anglo-Nubian originated in England from the crossing of English does with Nubian bucks from Nubia, the Upper Egypt and Ethiopia. The Nubian is known for high quality, high butterfat, milk production and withstand cold well as long as they are kept in dry, draft-free, well bedded quarters.



The head is the distinctive breed characteristic with the facial profile between the eyes and the muzzle being strongly convex. The ears are long (extending at least one inch [2.54 cm] beyond the muzzle when held flat along the face), wide and pendulous. They lie close to the head at the temple and flare slightly out and well forward at the rounded tip, forming a “bell” shape. The ears are not thick, with the cartilage well defined. The hair is short, fine and glossy. Nubians prefer warm climates, although with good housing in winter they will adapt well to any climate the other breeds can tolerate. Any colour or colours, solid or patterned, is acceptable.

Milk production is a bit less than that of the Swiss breeds, but through selective breeding the gap is being narrowed. Does on official test give an average of 763 liters of milk in a 305 day lactation.

Alpine

The Alpine is a large, graceful goat, with milk production comparable to the Saanen. This breed was probably derived from French-Swiss and Rock-Alpine ancestry and is now represented by several subbreeds of which the French-Alpine is one.



The Alpine dairy goat is a medium to large size animal, alertly graceful and the only breed with upright ears that offers all colours and combinations of colours giving them distinction and individuality. They are hardy, adaptable animals that thrive in any climate while maintaining good health and excellent production. The hair is medium to short. The face is straight. A Roman nose, Toggenburg colour and markings, or all-white is discriminated against. Alpine colours are described by using the following: Cou Blanc (white neck and dark hindquarters); Cou Clair (tan neck and dark hindquarters); Cou Noir (black neck and white hindquarters); Chamoisee (tan to red yellow) and Sandgau (black with white underbelly and legs and facial stripes). Does on official test give an average of 915 litres of milk during a 305 day lactation.

The American LaMancha

The American LaMancha is a recently developed breed of dairy goat from the USA. They were developed from short-eared goats of Spanish origin, a type given the LaMancha name in France, but known as Monas, or Monkeys in Spain. It has excellent dairy temperament and is an all-around

sturdy animal that can withstand a great deal of hardship and still produce. Through official testing this breed has established itself in milk production with high butterfat.

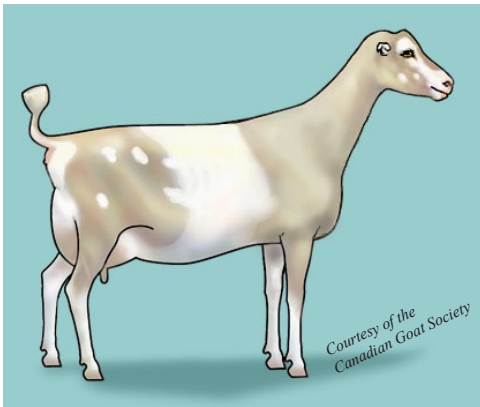

The LaMancha face is straight with the ears being the distinctive breed characteristic. There are two types of LaMancha ears, the gopher ears and the elf ears. The small “gopher ears” of 13mm is a dominant genetic trait; a Lamancha buck bred to a doe of any other breed will impart this character to the offspring. Any colour or combination of colours is acceptable with no preferences. The hair is short, fine and glossy. A production record for an American LaMancha is an average of 915 litres of milk in 305 days.

Instead of being tattooed in the ears like other goats, LaManchas are tattooed in the bare skin on the underside of the tail.

Oberhasli

The Oberhasli, the most recent herdbook to join the Canadian Goat Society registry, had been classed with the Alpine for many years until American breeders undertook to separate out the animals previously called “Swiss Alpines”. There were four types of alpines under the same American Dairy Goat Association herdbook with separate herdbooks kept for each: the Rock, British, Swiss and French.

Oberhasli are strikingly coloured; the does may be red-bay or pure black, but bucks must have the red “chamois” colouring. No significant amount of white is allowed in the coat. Ears are upright, the face dished or straight.



Market Goats

Market goats are goats, which are kept for meat purposes and are raised to be sold for use as “Chevon” (goat meat). In many parts of the world, “Chevon” is the only meat, which is available as goats are very plentiful. A market goat is not a particular breed of goat but a type of goat chosen for its heavier body and higher meat-to-bone ratio. These meat goats could be almost any bred, but many are Nubian or Nubian crossbred goats. Fast weight gain is important in good market animals. In recent years, importations of the South African Boer into North America means producers now have access to a breed selected specifically for meat and carcass traits.

“Chevon” is very lean meat and is similar to lamb in many respects. It should be cooked like lamb (low heat, high moisture cooking). Chevon is seldom found in large grocery stores, but usually in speciality butcher shops in urban areas.

South African Boer

Boers are specifically meat goats. They are large framed animals resembling, in many ways, the Nubian goat. The most obvious difference is the size. These goats were developed in South Africa for their meat, hardiness and brush control abilities. They have been selected for meat and carcass traits

for more than 40 years. Boer goats are known for good mothering ability, high prolificancy (1.93 kids per doe), and high fertility (98% of does bred had live kids). With extensive selection, growth rates have continued to increase, so that average weight at 100 days (weaning) is 25 to 30 kgs.

Boers are generally white with a reddish brown head and usually a white blaze down the middle of their face. Mature weights between 90 and 160 kgs for males and 55 to 90 kgs for females are considered normal. They have long ears that should hang down the sides of their faces. A Boer goat should have a deep broad chest, good back, strong shoulders and heavy muscling in the



Pygmy

Pygmy goats is recognised breed of miniature goat in Canada. On the average a full-grown doe stands between 40 cm to 55 cm at the withers. The head and legs are shorter than in other breeds but should be balanced in relation to body length. A goat in milk may give up to 2 litres of milk per day.



As they are compact, Pygmies do not require the amount of space and food that the larger goat breeds need. This has made them particularly popular with research labs, which keep goats because they are clean and easy to work with.

Nigerian Dwarf

Nigerian Dwarf goats have been developed as miniature dairy goats in North America. The mature buck is a maximum of 58.4 centimetres high at the withers; does can be no taller than 55.8 centimetres. Ears are erect, the facial profile is straight, and all colours and combinations are allowed, although the pygmy “agouti” pattern is seriously faulted.

The breed is mainly kept as pets, although some owners milk the does for the two litres or so that a productive doe can put out daily.

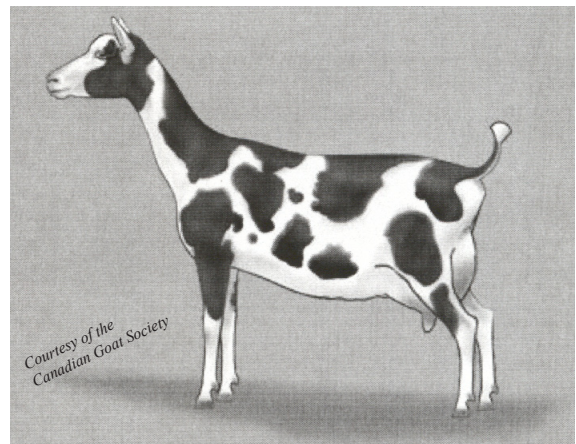

Fiber Breeds

Angora

Angora goats originated in the Himalayas of Asia. The fiber they produce is known as mohair and is from an Arabic work meaning “select” or “choice”. This select fiber is long, strong, warm, and lustrous and hangs in ringlets. Angoras are shorn twice per year as their fleece grows about 30 cms annually. Adult goats usually give approximately 10 kilograms of fleece per year (or more).

Angora goats are not milked but occasionally excess animals will be sold for meat and their hides made into throw rugs. They weigh 1.8 to 2.7 kgs

at birth and 36 to 54 kgs when mature. The average life span is about 10 to 12 years. The female goats are bred at about 18 months of age with a 145 to 150 day gestation. Unlike dairy goats, their horns are never removed.

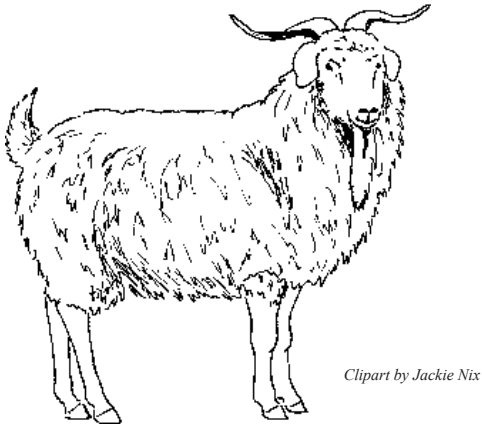

Cashmere

This is not a breed but a description of all goats that produce cashmere, a very fine fiber. Sixty percent of the world's supply of cashmere is produced in China. The first Cashmere goats were imported from Australia and New Zealand in the late 1980's. They are sheared once a year and a full-grown adult buck will yield as much as 1.1 kgs of fleece. The fleece consists of two kinds of fiber, cashmere and guard hair. Average cashmere percentage is about 20%.

WHAT TO LOOK FOR IN A GOAT

1. After you choose the type of goat that will fit your 4-H unit work, familiarise yourself with its breed characteristics. Refer to the section on "Judging Goats" for more details.
2. Large, alert, growthy and upstanding kid.
3. Free from disease and injury.
4. Good appetite, vigorous and healthy.

SELECTING YOUR GOAT

When selecting the goat for your project, you should be aware of type characteristics in order to select a good animal. The characteristics of importance to a dairy goat is:

- 1) general appearance
- 2) dairy character
- 3) body capacity
- 4) Mammary.

The meat type goats have five characteristics:

- 1) Structural correctness
- 2) Muscle
- 3) Volume and Capacity
- 4) Style and Balance
- 5) Growth Potential.

Dairy Type Goat

A good milking doe produces at least 4.0 kg a day. The doe should be selected with great care since an outstanding doe may be the nucleus of a very productive herd. Good body development is essential for good milk production. She should be angular and not round. Hipbones will be prominent, thighs thin providing plenty of room for a round, well-attached udder of fair size. The doe should have good length to the neck and body. The middle should be long and the rib should have great spring and depth denoting a capacity for consuming large amounts of roughage plus two or more kids.

The skin of the doe should be loose, pliable and free from dryness. Goats in proper condition have fine silky hair. In many cases, poor condition of flesh may be a clear indication of a good milker, while a poor milker may be found in good flesh. The neck should be thin and graceful, with or without wattles, and a feminine head. The eyes should be clear and bright. Does should be feminine in appearance and mild in temperament. Highly nervous goats are difficult to handle, milk, feed and manage, and may be upsetting to other members of the herd.

The milking potential of a doe cannot be estimated by size of udder. A large udder may give a very small amount of milk, especially if it is fleshy and lacking in quality. The udder of a good milk goat should be thin-skinned rather than meaty. The udder should show plenty of capacity and be well attached and supported by the suspension ligament so that banging on stones and other objects in the pasture or around the barn will not injure it. The teats should hang straight down and about the size of a thumb. When freshly milked, the udder should be soft to the touch and have a collapsed appearance.

Meat Type Goat

The mammary system of a meat type goat is not a selection characteristic, but the muscling is a strong characteristic. A meat goat should walk and stand wide for a heavier muscling. They should be wide through their chest floor, with bold shoulders and a prominent forearm muscle. The chest and forearm are the best indicators of muscling in thin goats. Goats should have a deep, heavily muscled leg and rump, with the widest part of the leg being the stifle area, when viewed from behind. They should have a broad thick back and loin that is naturally firm and hard handling.

To support the muscling, the goat's bone structure needs to be correct. Meat goats should be long bodied with adequate depth and spring of rib. All body parts should blend together for style and correctness. The last characteristic is the goat's Growth Potential which is the animal's ability to grow quickly; the fewer days on feed, the more profit for a meat goat producer.

BUILDING YOUR GOAT HERD

Your 4-H goat project could be the beginning of your future goat herd. To build a quality herd you need to start with good breeding stock. What good traits does your project(s) have and what improvements could you make through breeding. If the offspring have stronger qualities or show an improvement in the qualities you are breeding to

improve, then you are making progress.

The first step to improving you herd is to evaluate your herd as a whole and then each goat individually against a breed standard. The individual animal appraisal is referred to as linear appraisal. A doe is rated against the standard for the breed in four areas – general appearance, dairy character, body capacity and mammary. Bucks and young stock are scored only in the first three areas. Each animal is scored out of 100.

The score provides a comparison of all the offspring of a particular buck, thus giving type data. If you appraised a doe who has a strong mammary system and weak feet and legs, you will select a buck whose offspring have reliably strong feet and legs and that udders might not be as reliable. If your doe has a weak udder and strong feet and legs, you should use a proven buck whose daughters have reliably improved udders.

What does “reliability” mean? The improvement of your herd depends upon its genetic makeup. Some characteristic traits will be more influenced by genes than others. The strength of the gene to be passed to offspring is determined by its heritability strength.

Some examples of heritability of certain goat traits are as follows:

<u>Traits</u>	<u>Heritability (%)</u>
Number of Kids	10
Age at first kidding	54-77
General Body weight	50
Live weight at 7 months	49-77
Birth Weight	10
Total milk yield	25-40

For those traits, such as type or conformation, the breeding system is important. The breeding system looks at the relationship between the doe and the buck. There are five different breeding systems a breeder could choose from to increase trait quality in the offspring.

- 1) Inbreeding: Mating of closely related animals such as brothers and sisters or parents and offspring.
- 2) Linebreeding: Using a succession of related sires that are not more than 25% related.
- 3) Out Crossing: Mating two unrelated animals within the same breed. This system will likely increase hybrid vigour and reproductive performance.
- 4) Cross Breeding: Mating of two different breeds.
- 5) Grading Up: Continued mating of grade (unregistered) does to purebred sires to upgrade animals and their offspring until they qualify as Canadian for their breed. This is 7/8 for does and 15/16 for bucks.



To improve the quality of a goat herd, a knowledge of genetics and various breeding systems, good records, patience, and a willingness to make difficult decisions. To improve desirable characteristics, one must be willing to cull against undesirable characteristics. Some traits to cull for are: overshot or undershot jaw, extra or double teats, an undescended testicle, weak anatomical structure or incorrect conformation and colour for the breed.

BREEDING

Breeding Ages of Bucks and Does

Bucks can breed at three months, and doe kids can become pregnant at three months, so be sure to keep them separate from an early age. Bucks should not be used for breeding until they are six months. Young does should only be bred when they have attained sufficient development; therefore care must be taken to see that they do not mate before reaching a sufficient size.

Young does should be at least 36 kg (80 lbs.) and have a heart girth of 75cm (30") before they are bred. Milk goats reach their prime for milk production at about 4 years of age, but a goat possessing a strong constitution and continuing good health may be useful as a milker and breeder for over 10 years.

In his first season of breeding, a young buck can be used two to three times per week and service a total of 12 does that season. In his second year, he can service an average of 20 does/season and upwards of 40 does/season in later years.

BREEDING SEASON

For most dairy goat in Canada, the breeding season extends from late August to January. During these months, the number of daylight hours is decreasing. *Note, Pygmy goats are year round breeders and Boer goats breed September to March*) Goats are very sensitive to the seasonal change of temperature and light. As the days become shorter and the weather turns cooler, does will begin coming into heat, and bucks will come into rut (develop a strong musky odour and can become aggressive in behaviour).

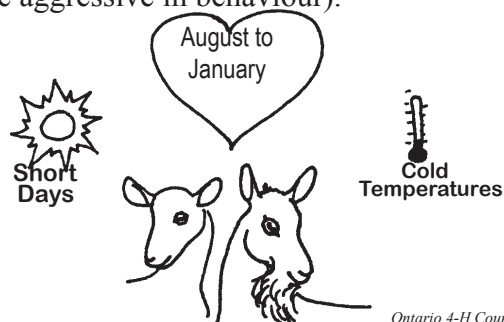

Ontario 4-H Council

Out-of-Season Breeding

It is possible for the farmer to “trick” goats into thinking that it is breeding season – even in the summer months. Out-of-season breeding can be practised by controlling the amount of light does and bucks receive. The farmer keeps the barn lights on for “long days” in the winter months, and then decreases the length of day in the barn by turning the lights off to create increasingly “shorter days” at the time when he or she wants the breeding season to start. However, this does not always work. Often, the farmer must also use hormone injections and/or hormone soaked sponges that are inserted into the doe’s vagina.

BREEDING OF GOATS

Estrous Cycle (also know as a heat cycle)

During the breeding season, the doe’s ovaries produce ova (called eggs) approximately every three weeks. This three-week period is known as the estrus cycle. For a short time during the estrous cycle, does are in heat or in estrus. During this time, the doe will show interest in the buck and will stand for breeding. This period of time lasts for about 18 to 24 hours. It is important to recognise signs of heat in does because the heat period is very short and because does will not stand for breeding once this time has passed.

Signs of heat include:

- tail flagging (rapid wagging of the tail)
- restlessness, bleating, little interest in eating
- does fighting with each other
- slight swelling of the vulva
- does trying to mount each other
- clear mucous discharge, which turns whitish at the end of the heat period (this can usually be seen by examining the hair on either side of the doe’s tail. The hair will become sticky and glued together during heat).

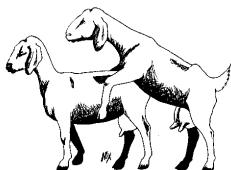

Clipart by Jackie Nix

REPRODUCTIVE TRACT OF THE DOE

(Side View)

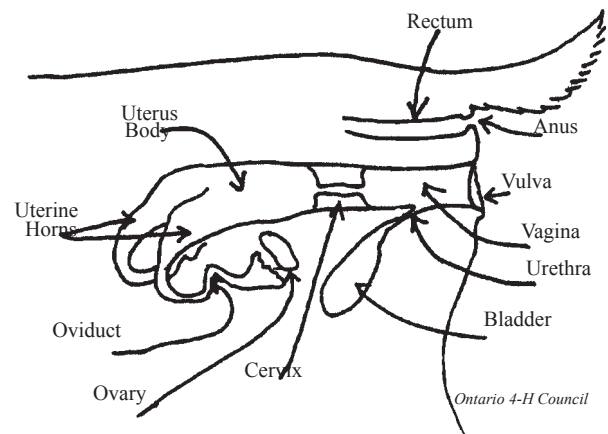

If a doe will stand for breeding, she will usually become pregnant (unless she or the buck have physical problems that might prevent pregnancy).

NATURAL BREEDING

The doe should be taken to the buck and left until he services her at least once and preferably twice. Conception rates and multiple births may be increased if she is taken back to the buck within ten hours for a couple of more breedings. Do not leave the doe with the buck for long periods of time. Never leave a doe in a buck’s stall if she is not in standing heat. A buck may become very aggressive if she does not show interest in him – some will seriously injure the doe.

ARTIFICIAL INSEMINATION (A.I.)

A.I. is sometimes used for goats. Buck’s semen can be successfully collected, frozen and stored. There are hands-on courses available to teach A.I. skills so that the goat owner can perform A.I. himself/herself. Achieving good conception rates with A.I. may be difficult because of inaccurate timing of insemination, and incorrect placement of semen.



Ontario 4-H Council

However, A.I. does offer some benefits:

- Eliminates necessity of keeping a buck
- May increase the rate of genetic improvement
- Allows breeding to many different bucks
- Permits breeding many does on one day when does are synchronised
- Reduces danger of transmission of diseases or parasites
- More carefully regulates time of breeding and kidding
- Promotes good record keeping of dates of heat, breeding, pedigrees, etc.

BREEDING PROBLEMS

Once a doe has been serviced, either naturally by a buck or through A.I., there can be various reasons as to why she may not conceive:

- bred at the wrong time
- infertile buck or doe
- nutritional problems in does
- ovary problems
- health problems – illness other than reproductive
- infection in uterus or cervix
- excessively hot weather

BREEDING PROBLEMS IN POLLED GOATS

There is a genetic (inherited) trait that sometimes causes breeding problems in goats. Two parent goats may carry this trait which causes sterility in their young. The young are born with a reproductive system which does not function properly (it is often incomplete). The trait for reproductive problems is not visible in the parents, but the gene responsible for this problem is expressed or “turned on” much more often in polled goats than it is in horned goats.

To avoid possible breeding problems in the young of a polled doe, she should always be bred to a horned (or disbudded) buck. By avoiding a polled-to-polled breeding, you will reduce the chances of having goats give birth to offspring with inherited reproductive problems.

A horned goat is any goat that is born with the beginnings of horns. The horns may be allowed to grow to full size or they can be removed by disbudding. But, both goats are still considered to be “horned” for the purposes of genetics and breeding.

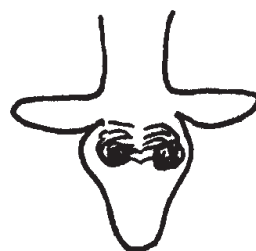

Ontario 4-H Council

A horned kid usually has a little swirl of hair over each horn bud. The horn bud is pointed rather than flat.

A polled goat is a goat that has inherited genes from its parents that prevent it from ever growing horns. It does not need to be disbudded.

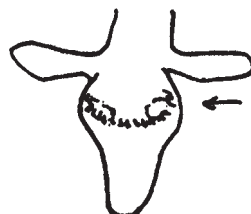

Ontario 4-H Council

Polled kid has a smoother coat of hair on top of the head. It also has oval, flattened bumps where the horns should be.

KIDDING

Gestation – Gestation is the length of time from conception to kidding and is normally 150 days (about 5 months). Young does will usually give birth to one or two kids in their first kidding. Most older does will have twins, or occasionally triplets. Once in a while, a doe will have quadruplets.

Kidding Kit

Assemble these items before the doe is due to kid.

- clean pail
- towels
- mild iodine washing solution
- K.Y. jelly, mineral oil or some other type of lubricant
- Iodine solution for dipping navels

KIDDING AND KIDDING PROBLEMS

A few days before kidding, a doe may show one or more of the following:

- The udder will begin to fill up with milk.
- The doe's backbone ahead of the tail will become raised and loose feeling.
- The doe's vulva will become swollen and pink.
- The doe may lie around and breathe loudly, or even make small grunting or groaning sounds between chewing mouthfuls of cud.

A few days before the doe is due, you may clip her udder, hindquarters and tail. She should be in a small, clean pen by herself. You can give her a laxative-type feed such as bran at this time, along with her regular ration.

Close to kidding, the doe may:

- Become restless and begin pawing at the bedding
- Look as though she is listening for a noise, make small cries, answer any goat kids that she hears crying in another part of the barn;
- Lie down and then get up again, repeatedly.

Remember to remove water pails from the pen when delivery is expected. Newborn kids do not swim well!

At kidding, the doe may:

- Paw very hard at the bedding and lie down in the depression made;
- Lie against a wall with one hind leg stretched out while she attempts to push out the kids.



Ontario 4-H Council

After the doe has been in heavy labour for several minutes, she will push out a water-filled birth sac. In a normal delivery, the kid's front feet should appear within the sac as the doe pushes the kid out.

After some harder pushing, the kid will continue to come out. The doe may be lying down or standing up as this is happening.

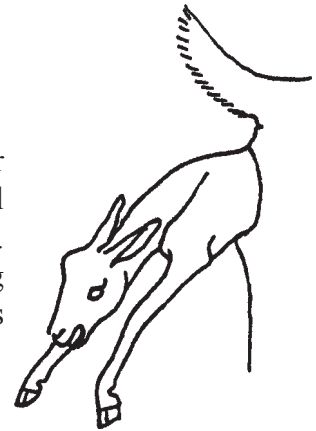

Ontario 4-H Council

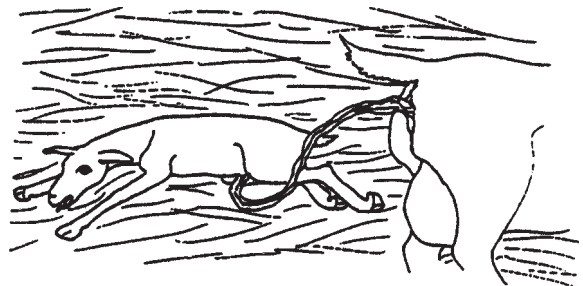

Ontario 4-H Council

Finally the kid is pushed completely out. The umbilical cord may still be unbroken. It should be broken off about 10-15 cm from the kid. Be sure that you don't pull on the kid's navel as you tear the cord. Hold the cord on either side of where you want it to break, then slowly pull that section until it stretches and breaks. Dip the navel in iodine immediately after breaking. This will help to prevent bacteria from entering the kid's body through its navel.

You should suspect problems if:

- Goat does not produce a kid within about 20 minutes of fairly hard pushing;
- A water sac breaks, but no kid appears, even after several minutes of pushing;
- Doe is in an abnormal amount of physical distress – crying out or lying flat on her side (although some goats will cry out loudly when they are kidding).

If there are problems: Contact your veterinarian or an experienced goat owner to ask advice. Do not take chances. If a goat pushes for too long, kids can be injured, or may die. Also, the doe may be injured during a difficult delivery.

NEWBORN KID CARE

After the kids are born, give the doe some warm water with a little molasses and salt added. Make sure the doe's teats are clean and colostrum, or first milk, flows before the kid nurses. Help the kid only if it doesn't start nursing on its own within 15 minutes.

Kids should receive colostrum as soon as possible, preferably within the first hour and certainly within six hours. The colostrum contains antibodies that help the kids resist disease. Newborn kids that cannot get colostrum quickly use up their limited supply of energy (glucose). They develop a condition call birth chilling. Kids can quickly die if not treated with a glucose solution and colostrum.

Don't forget to:

- Disinfect the navel by dipping it in 7% iodine to prevent navel ill;
- Give vitamin A&D injections;
- Give a vitamin E, selenium injection to one-week old kids (in areas of selenium-deficient soils).

Whether the kids remain with the doe or are bottle fed, they will need a warm draft free area to run and jump. A heat lamp is useful in colder climates.

TATTOOING

In a small herd, you can usually recognize each of your goats without permanently marking them. If you intend to register, sell, or keep accurate records of your goats, then marking each goat is necessary. The preferred form of identification is ear tattooing for goats and in LaManchas, the tattoo is placed in the tail web.

The following is the procedure for tattooing.

- a. Halter or muzzle the animal if necessary.
- b. Put the correct symbols in the tattoo pliers. For the right ear, use three letters assigned to each breeder by the breed association. In the left ear, use a letter showing the year the goat was born and a number to distinguish it from its mates born in the same year. Birth year letters "L" for 2001, "M" for 2002, "N" for 2003 and so on down the alphabet. The letters O, Q, V, and I are not used.
- c. Punch a piece of paper first to be sure the information is correct and then punch the bottom of the Application for Registration so you have a permanent record.
- d. Restrain the goat. Cleanse and disinfect the ear area with alcohol. Let it dry.
- e. With an old toothbrush smear green ink on the skin midway between the veins and cartilage of the ear.
- f. Line up symbols parallel to the veins or cartilage. With quick, firm movement squeeze the pliers together. With your toothbrush immediately apply more ink, gently but firmly for at least 15 seconds to insure penetration into the skin. If any blood appears, reapply ink. Do not remove excess ink.
- g. Clean the rubber pad and needles with alcohol.

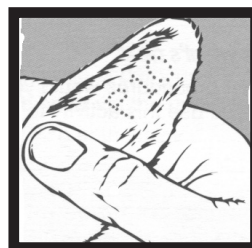

DEHORNING OR DISBUDDING

Dehorning is advisable for dairy and pygmy goats because:

- a) It prevents injuries to other animals in the herd.
- b) Dehorned animals are safer to work with.
- c) Dehorning is required in the show ring and at fairs.

Electric dehorning is a $\frac{3}{4}$ - 1" electric disbudding iron is the recommended method of dehorning goats, as it is the quickest and most sure way of getting a neat and completed dehorning.

***Caution:* Never use disbudding pastes or caustic sticks. They can cause blindness in the kid and udder burns to the dam.**

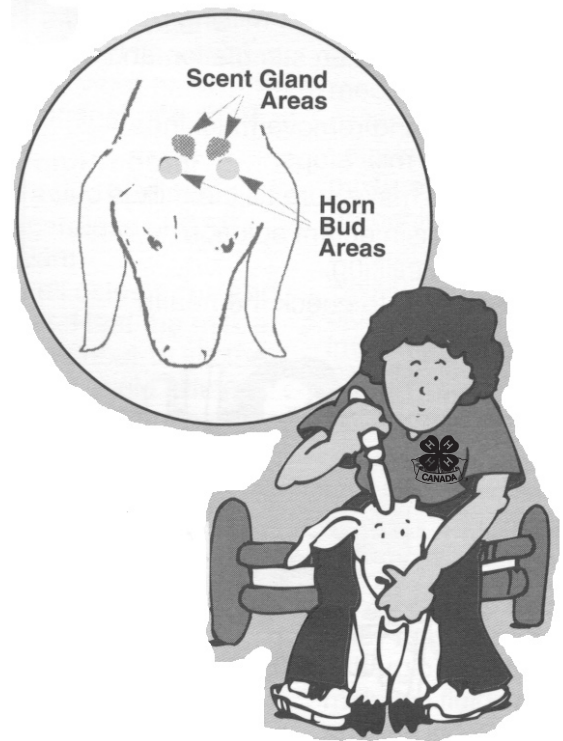

The following procedure is recommended:

- a. Start checking several days after birth for horns. If the skin moves freely over the horn bud the kid is hornless. If the skin is tight against the head and if the horn button can be felt it is time to dehorn.
- b. Restrain the kid as humanely as possible, keeping the ears out of the way. A dehorning & tattooing box is recommended.
- c. While the dehorning iron is heating, clip the hair around the horn bud.
- d. Test the heat of the dehorning iron. It is ready when it will burn a dark ring on a piece of wood quickly.
- e. Move the handle of the disbudding iron in a circle on the horn bud for approximately 8 – 12 seconds, until a copper-coloured ring form around the base.
- f. Make criss-cross marks across the exposed areas to keep scars from forming.
- g. Ice could be applied to make the goat more comfortable.
- h. Commercial sprays and powders are available to help prevent infection.

Dehorning & Tattooing Box

Members may wish to construct a dehorning and tattooing box as shown below. Kids can be easily held in such a box making dehorning and tattooing an easier job.

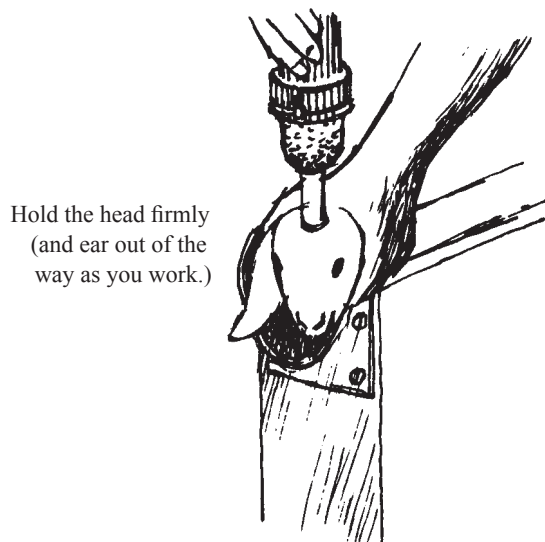
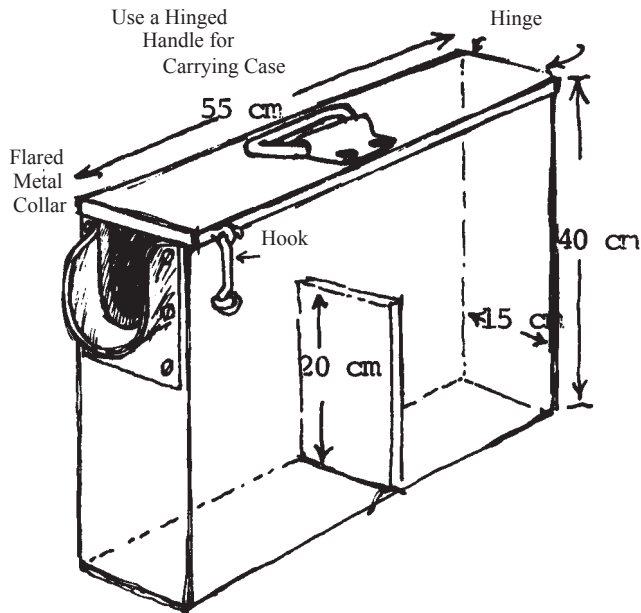

Hold the head firmly
(and ear out of the
way as you work.)

MILKING

After kidding, the doe will begin her **lactation** (the time when a goat or any other mammal produces milk). During the first two days of the lactation, the doe will produce **colostrum milk**. This is a very thick, yellowish milk that contains extra nutrients and antibodies that are passed on to the kid. After this, the milk will change to regular milk and the goat will produce milk while her kids are nursing, or for as long as the farmer milks the goat (usually for the next 10 months)

HAND MILKING OR MACHINE MILKING?

When the goat is stimulated, pressures inside the udder increases and milk flows into the teat. Stimulation happens when the goat enters the milk stand, has her udder washed or sometimes when she hears the sound of the milking machine. All or any of these events will cause her to let milk down into her udder so that it can be milked out.

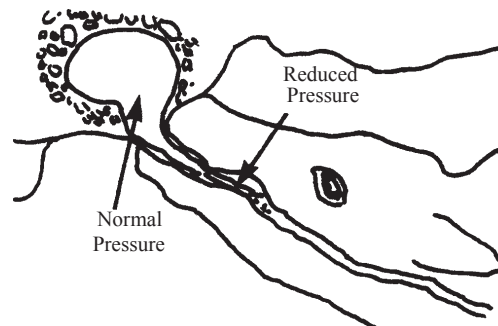

Ontario 4-H Council

When the kid sucks, a vacuum, or suction is created at the teat end, much like happens when you suck on a straw in a milkshake. The lack of pressure forces the milk into the kid's mouth, or the milkshake into yours.

The milking machine creates a vacuum at the teat end similar to a kid sucking. Milk is automatically released into the milking machine. The pulsing of the milking machine is a lot like the drinking action

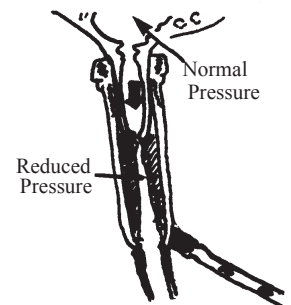

Ontario 4-H Council

When you hand milk a goat, you squeeze the milk out of the teat. Your hand pinches off the top of the teat, trapping milk inside. The increased pressure inside the teat forces the milk through the sphincter muscle at the teat opening.

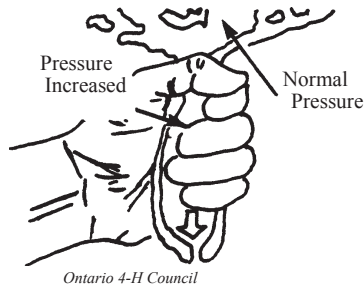

Ontario 4-H Council

THE CORRECT MILKING PROCEDURE

Good milking practices are a must for your dairy goat herd. Clip long hair from udder, flank, belly and tail. Have a clean, separate milking area. Stay calm and quiet in the milking area and be patient.

1. When hand-milking, be sure hands are thoroughly washed and dried before milking.
2. Wash the udder with udder wash.
3. A gentle massage of the udder during the washing aids in stimulation and milk let down.
4. Dry udders with individual paper towels before milking begins.
5. The first two streams of milk from each half should be milked into a strip cup. Check for flaky or clotted milk. Discard this milk as it may contain bacteria from the teat ends.
6. Milk goats and remove machines immediately when milk stops.
7. Massage udder to make sure all the milk is out.
8. Dip each teat in a commercial teat dip. This will prevent bacteria from entering the teat canal and causing a mastitis infection inside the udder.
9. Milk all CAE goats or those with mastitis last. Discard this milk.

The regular use of a teat dip helps protect the udder from infections. If you are using the CMT (California Mastitis Test), or similar tests, you can see slight changes in the milk that could be the result of mastitis infection.

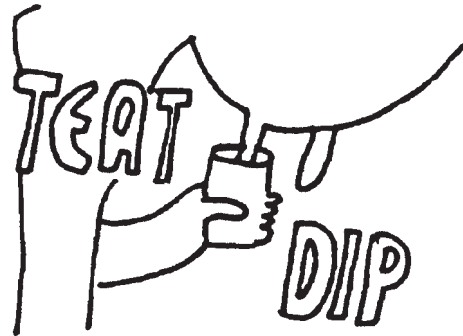

Ontario 4-H Council

Remember - Discard the milk from animals treated with antibiotics.

MILKING EQUIPMENT

The goal in milking goats is to milk them quickly, and expose them to as little stress from the milking machine as possible. How well the milking equipment is working is very important in helping to prevent stress on goats.

Milking equipment should be tested regularly (once a year) to ensure that it is working properly. Some milking equipment problems can only be determined by using proper testing equipment.

For fast milk-out, vacuum should be set at 12" mercury and the milking equipment components (vacuum pump, milk lines) sized according to the number of milking units being used. If there is not enough vacuum, teats will not be massaged enough and irritation or stress can occur.

A pulsation ratio of 60:40 (liner open 60% of time, and closed 40% of time) is recommended. If a wider ratio such as 70:30 is used, once again there may not be enough time spent on teat massage.

CLEANING AND SANITIZING MILKING UTENSILS

Milking utensils must be thoroughly cleaned before and after each milking to ensure an acceptably low bacteria count in the goat's milk.

1. **Rinse** all pails, buckets, and other utensils with lukewarm water immediately after use.
2. **Add detergent** to hot water in the sink according to the directions on the container.
3. **Soak** the utensils and equipment in the wash for about five minutes to remove soil.
4. **Scrub the utensils** and all surfaces, with the brushes designed for the job. An acid cleaner should be used regularly instead of the alkaline detergent, as these prevent mineral deposits from forming on the equipment.
5. **Rinse** each piece of equipment with hot water.
6. **Drain** all pieces of equipment and utensils by placing them on a non-rusting rack at least 50 cm above the floor. Allow them time to drain dry.
7. **Sanitize** all pieces of equipment **just before** the milking is to begin. Fill a sink with the appropriate solution and allow the equipment to sit in it for at least 5 minutes.

It is important to follow the instructions on the labels of all chemical solutions.

DRY GOAT TREATMENT

It is advisable to treat any does with a history of mastitis when they dry off (stop producing milk) with a long lasting intramammary antibiotic. The antibiotic to use would depend on the organisms identified from milk samples taken earlier in lactation.

Cleanliness when giving the antibiotic is essential:

- swab teats with alcohol
- shake the antibiotic tube well

- insert tip of tube against or slightly inside the teat opening as you inject the antibiotic (do not insert the tip far into the teat)
- massage teat and udder to work antibiotic throughout udder
- Use only individual tubes of antibiotic.

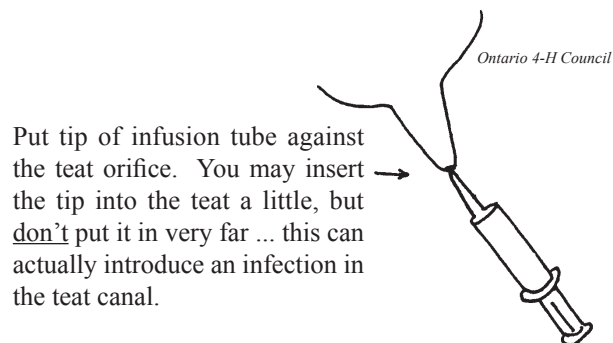

MILKING COMFORT

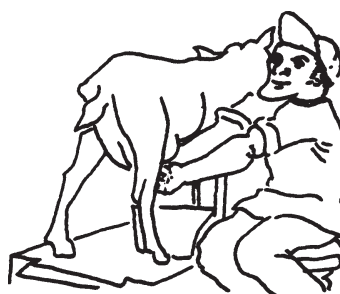

A raised platform with a seat attached is ideal ...

Although a few people always do things the hard way.



Ontario 4-H Council

MILK RECORDING PROGRAMS

Dairy producers depend on management tools such as milk recording to improve efficiency of production and in turn to increase financial returns. Accurate, up-to-date and meaningful records are required to make effective herd management decisions.

Why should records be kept?

1. To show the contribution of each doe to the total herd income.
2. To be able to manage does according to their production.

3. To cull effectively, replacing poor or older does with young, promising stock.
4. To determine which sire would be a good mate for a particular doe in your herd.
5. To aid in the marketing of does sold for milking.
6. To provide guidelines for feeding, breeding dates and kidding dates.
7. To maintain good health in the herd. Health problems such as mastitis can be indicted by fluctuations in production and somatic cell counts.

Milk tests taken indicate the percentage of protein and butterfat. High butterfat production is needed for cream products such as butter, and ice cream. These milk records could help the breeder to breed specifically for butterfat by indicating, which does produce the most butterfat consistently. The Canadian Goat Society offers a milk test program.

Bad flavoured milk can result if the protein percent becomes higher than the butterfat percent. Milk records assist the dairy farmer to locate animals that consistently maintain good levels of protein and correct the problem of bad flavoured milk. Don't cull for production on first lactation. If second lactation still doesn't meet herd standards, culling should be considered at that time.

MILK MAGIC

Milk has been labelled the "almost perfect food" and goat's milk is no exception.

Now let's learn more about the composition and nutritional value of a dairy goat's milk. Tables 1 and 2 illustrate a comparison of the nutrient content of goat's milk to that of other mammals.

Table 1. Average Composition of Milks of Various Mammals¹

<i>Species</i>	<i>Water</i>	<i>Fat</i>	<i>Protein</i>	<i>Lactose</i>	<i>Ash</i>	<i>Nonfat Solids</i>	<i>Total Solids</i>
Goat	87.00	4.25	3.52	4.27	0.86	8.75	13.00
Cow	87.20	3.70	3.50	4.90	0.70	9.10	12.80
Ewe	80.71	7.90	5.23	4.81	0.90	11.39	19.29
Human	87.43	3.75	1.63	6.98	0.21	8.82	12.75

¹ Data from: Fundamentals of Dairy Chemistry, page 6. Ed.: Webb B.H. and Johnson, A.H. 195. The AUI Publishing Co., Inc. Westport, Connecticut

Table 2 compares specific vitamins found in goat's milk with that of milk from cows and humans. All of these factors will vary depending on the season, diet and condition of the animal. The figures shown in charts and information about contents of milk should be taken as averages.

Table 2. Average Vitamin Content of Goat, Cow and Human Milk

<i>Vitamin</i>	<i>Cow</i>	<i>Goat</i>	<i>Human</i>
Vitamin A ¹	1560.0	2074.0	1898.0
Vitamin D	-	23.7	22.0
Thiamine (B ₁)	0.44	0.40	0.16
Riboflavin (B ₂)	1.75	1.84	0.36
Nicotinic Acid	0.94	1.87	1.47
Vitamin B ₁₂	0.0043	0.0006	0.0003
Ascorbic Acid (Vit. C)	21.1	15.0	43.0

¹ Vitamin A expressed at International Units/liter; all others as mg/liter

Data from: Parkash, S. and Jenness, R. 1968. The Composition and Characteristics of Goats' Milk: A Review. Dairy Science Abstracts. 30 (2):67.

Milk Fat

The high proportion of butterfat gives goat milk a greater energy value per unit volume than cow's milk. Fat is a concentrated source of energy and in general, one unit of fat contains 2.5 times more energy than one unit of carbohydrate.

Lactose

The lactose content of goat's milk is slightly lower than cow's milk. Lactose is a milk sugar and is the carbohydrate nutrient in milk. Since some people have difficulty digesting the lactose in milk, goat milk is less likely to cause this problem than cow's milk. For yogurt making, the low lactose of goat milk gives a less acidic and more palatable product than cow's milk with no need for fruit or flavouring.

Protein

There's no important difference in cow's milk and goat's milk protein composition. But the physical characteristics of the curd that these proteins formed under the action of rennin (the principal enzyme secreted by the newborn stomach) is significant. Generally, the softer the curd, the more easily it is digested. The curd of cow's milk is harder than the curd of goat's milk. Size also has something to do with its digestibility - and the curd of cow's milk is large and dissolves more slowly. The finer curd of goat's milk dissolves more rapidly. This means that for some people with digestive difficulties, goat's milk may be more easily digested.

Minerals

Goat's milk generally contains more calcium, phosphorous, chlorine, magnesium and potassium than cow's milk or human milk. The amount of phosphorus in goat's milk helps people living on a diet of root plants, fruits and green vegetable. It also contributes to the higher buffering capacity of goat milk which makes it valuable in treating stomach ulcers. The high chloride content may have some bearing on its laxative properties.

Vitamins

For the adult milk-drinkers, goat's milk provides approximately twice the Vitamin A obtained from cow's milk. Vitamin B is concerned with nervous control. The human need of this vitamin is thought to increase with the intake of sugar and other carbohydrates; there's some evidence also that it plays a part in protein digestion and metabolism. Goat's milk is 50 percent richer in Vitamin B than cow's milk, four times as rich as human milk. Goat's milk is very high in riboflavin (Vitamin B₂), which affects growth. Vitamin C and D are not present sufficiently in cow's milk or goat's milk, and any child that is bottle-fed will need supplements.

Breed Differences

The composition of goat milk varies both within and between breeds, just as it does with cows. Milk from the Saanen and Toggenburg breeds resembles

milk of Holstein cows in percentage of water, lactose, fat, protein and ash, although it is subject to greater variation with the advance of lactation than Holstein or Jersey cow milk.

Toggenburgs are often know as the 'Guernsey' of the goat family because of the quantity of milk they produce. Nubians produce less daily milk poundage than other breeds in general, but their milk is higher in butterfat content.

Various values have been reported for each of the nutrients in goat milk, probably as a result of analyzing milk from a single breed or herd or with the techniques used. But, like cow's milk, goat's milk is a healthful and nutritious food.

PASTEURIZATION

Louis Pasteur, 1822-1855, was a French scientist. He was the first to discover that bacteria could be killed if milk was heated to a high temperature and held there for a specified time, and then quickly cooled and maintained at a low temperature.

Pasteurization is a process which is used to protect the consumer's health. The reason food is pasteurized is to ensure that the food will become free from disease-producing bacteria. This process actually makes our food last longer because the harmful bacteria have been destroyed. Raw milk, under some conditions, may contain disease-producing bacteria even when handled under ideal conditions. However, pasteurization does not take the place of correct and careful handling of the food product.

All milk and cream products sold in retail stores are pasteurized.

Fresh milk from the farm may present health risks because of the harmful bacteria which may be present.

To pasteurize milk and cream, use a double boiler. Heat the milk and cream to 82°C and hold it at that temperature for 30 minutes. Stir frequently to

prevent burning. A skin will form on the surface of the milk; skim this off.

After heating, cool quickly in cold water and then refrigerate immediately to 5°C or below. Home pasteurizers that will pasteurize eight litres of milk - enough for family consumption - are available at reasonable cost.

Keeping Milk Sweet and Clean

Some people believe that goat's milk does not keep sweet as long as cow's milk. Tests show this is not true. The keeping quality depends on the conditions under which it is produced and handled.

Good goat milk does not have any stronger flavour than good cow's milk. If your milk has a strange

- Keep the buck (male goat) in separate quarters. Male goats have a distinctive odour which can be imparted to the milk if they are kept close by or with the does. (Does, however, are almost odourless.) All conscientious goat breeders keep the buck in separate quarter at least 50 feet from the milking doe. (If you have only a small herd, you may not wish to keep a buck.)
- Make sure your animal is healthy. Your does should be sleek-looking, appear alert, without abscesses or growths. If she seems ill or listless or there is any question about her health, have her checked by a veterinarian and have the milk tested.
- Check your shelter. Poorly ventilated barns, not generally well kept, can affect the milk flavour. A milking doe should be kept in a clean, dry area with clean hay and an exercise yard of some type.
- Keep milking conditions sanitary. This means the goat, the building and the utensils. The animal should be clipped, particularly in the udder area to prevent loose hairs, dust or dirt from getting into the milk during milking. (During late fall and winter, you may wish to just clip the udder area; goats are thin-skinned and need the thicker winter coat of hair for protection from cold.)



Before milking, wash and disinfect both the udder area and the milker's hands and arms. Set aside a special milking area not in the regular quarters if at all possible. This minimizes dust from alfalfa, dirt and hay which can get into the milk. A separate building or walled area is ideal.

Thoroughly wash and sanitize all utensils after each milking and keep them in a clean place. Bacteria develop rapidly in equipment which has not been thoroughly cleaned. The bacteria will cause a breakdown in the milk, resulting in quicker spoilage. A malty flavour can develop from improperly cleaned equipment. Metallic flavours can be picked up from old, or exposed copper equipment, milk cans or lids. Old tin-plated equipment which has begun to wear can cause an oxidation process which results in a tallow-like flavour.

- Refrigerate milk quickly after milking. Milk may develop an acid or coarse taste as a result of bacterial growth. A rancid flavour can also result from extreme agitation of warm raw milk in the presence of air (foaming.) If milk is left in a glass container in the sun, even for a short time, it may develop a rancid taste resembling stale fat. Ideally, it should be carefully strained and stored in seamless aluminium, stainless steel or glass containers. Plastic may impart an unwanted flavour. After milking, place the milk immediately in a milk cooler or refrigeration unit.

Use your fresh milk within a few days. If it is held too long at low temperatures, it may develop a sour taste. This is caused by a change in lactose (milk-sugar) which results primarily in the development of lactic acid.

- During the latter part of the lactation of some does, the milk may begin to develop a flavour. If the doe normally has good-tasting milk and there is no reason for a change in taste—that is her food, quarters and health have remained stable - this may be a reason. However, a doe whose milk is poor tasting while still milking strong should be checked. Occasionally, but very rarely, an animal is found with poor-tasting milk. This trait does run in a few families of the Toggenburg breed. But the large majority of poor-tasting milk results from other factors.

OTHER GOAT PRODUCTS

Many products besides milk are produced by goats. Goat hair and leather provide materials for clothing. Goats are great companions, too and many people keep a goat for the simple enjoyment of having one for a pet.

Milk is a very nutritious food but did you know that cosmetics and health care products such as toothpaste, bath oils, and lotions can be made from milk?

Mohair is grown on Angora goats. It is hair, not a wool, and it is very strong. Mohair has a beautiful lustre which makes it a popular fibre for clothing. Angora goats are sheared twice yearly and they produce a clip of between 3 and 6 kg at each shearing. Handspinners and weavers enjoy working with mohair as it is beautiful and versatile.

The Cashmere goat lives in the mountains of Tibet. The cold climate there encourages the growth of a fine undercoat on this long-haired goat. In the warm spring weather this undercoating is shed, much as a long-haired dog sheds its winter undercoat. This fine wool called cashmere, can be combed from the animals or collected from bushy areas where the animals browse. This wool is soft and fine but lacks the strength and lustre of mohair.

Kid leather has been thought of as the softest and most delicate of leathers for many years. Kid skins,

in this country, are most often discarded because of the expense of curing and tanning. Italy produces the most articles made from kid leather than any other country in the world.

Many people choose a goat that will be a companion or a pet. While working with your project so far, you have probably noticed how friendly the goat is. It responds well to people and seems to enjoy being with people. If you have started training a goat, you must have noticed how eager the goat is to learn. Many children and their families have made or purchased carts and have easily trained their goats to pull them. Packs are available to have your goat carry a back pack and join you on hikes.

Goat meat is called chevon. Market goats are those which are kept for meat purposes. Chevon is in great demand, especially in ethnic and gourmet markets. Many ethnic groups from Europe, Asia and the West Indies enjoy chevon, as this was a staple meat in their home country. Each culture has a preference for a particular cut of meat, depending on where they are from and how they intend using the meat. Examples would be the curry enjoyed by the people from the Caribbean Islands, and national dishes such as moussaka from Greece.

Goat meat is a delicacy. It is a lean, high protein meat with a delicious taste all its own. Kid meat has absolutely no fat and is always best if marinated in oil and herbs. Larger animals are dressed and cut similarly to lamb and include chops, ribs and roasts. Older animals provide excellent ground meat and curry, while the bucks supply curry and salami.

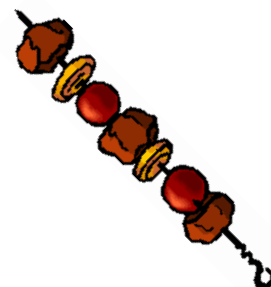





NUTRITION

What is Nutrition?

Nutrition is the process through which animals and plants turn food materials into energy.

We need energy in order to live, to grow, to work, and to play. Many things need energy in order to keep moving. Below are some examples of types of energy and the objects or animals that would use them to function.

Diesel fuel	tractor	
Grain and hay	goats	
Fertilizer	vegetables	
Fish	whales	
Electricity	television	

Goats (and all other living things) need nutrients from food in order to produce energy to live and function. Proper nutrition is very important to all goats, but particularly to young growing goats.

Goat owners must care for their animals and feed them properly to give them a chance to grow well and to produce milk, meat, offspring or fibre (wool, hair, etc.) to their full potential.

It is important to know the nutritional requirements for the kind of animal being raised. This means that we must know what nutrients are needed by that animal to be able to live and grow. We must also know how much of each nutrient is needed to meet the animal's needs.

A nutrient is like an ingredient in a recipe. If we leave some nutrients out of an animal's diet, it will cause some type of deficiency (a shortage). This

will result in problems such as low milk production, slow growth or disease.

Foods and Their Use

Animals require food for three main purposes, which are as follows:

- 1) to give heat and energy to the body
- 2) to provide essentials for building various body tissues
- 3) to supply materials for bone building

The primary food nutrients required by all animals are classified as carbohydrates, Fats, and Proteins. Secondary food nutrient classes consist of Minerals and vitamins. Other nutrients of much importance are Water and Air, but they are obtained primarily from sources other than foods.

What's in Feed

<u>Nutrient</u>	<u>Use</u>	<u>Where It Comes From</u>
Proteins	Growth	Legume hays (alfalfa, clover)
	Development of glands,	Linseed meal
	Muscles, hide,	Immature grasses
	horn, and hair	Skim milk
	Repairing body tissues	Wheat bran
	Milk products	Oats By-product feed
Carbohydrates	Energy for body Maintenance	Grains (oats, barley, wheat, corn)
	Growth	Molasses
	Milk production	Hay
		Silage
		Pasture
Fats	Energy	Small Quantities in Grains (oats, barley and wheat) Flax seed Soybean seed
Minerals	Skeleton	Trace mineralized salt
	Essential parts of Enzymes and hormones	Dicalcium phosphate Steamed bone meal Calcium legume hays Phosphorous in grains and Oil meals

<u>Nutrient</u>	<u>Use</u>	<u>Where It Comes From</u>
Vitamins	Growth	A – green leafy forages,
	Aid in digestion	yellow corn
	Help in disease prevention	B – produced by bacteria in the rumen
		C – produced in digestive tract
	D – sunlight, fish oils, irradiated yeast	
E – grains		
Water	All vital processes of the body. Digestive processes Removal of wastes Regulates body temperature	Must be supplied at all times

Use of Nutrients in the Body

The animal requires nutrients for the following purposes: maintenance, growth, and production of milk, reproduction, fattening and work.

Maintenance

The animal must be kept warm, and must have energy for the work of eating and digesting food, for breathing, for the work of the heart, and for moving itself about. In addition, the tissues must be kept in repair, and nutrients are required for growth of hair and hide.

The principle requirements for maintenance are energy and heat producing nutrients. Maintenance takes first priority on the use of the feed. If fed below maintenance needs, the doe will use up her body reserves of fat and other nutrients, dropping off rapidly in milk production. Eventually, when these are used up, starvation or serious malnutrition sets in and her health is affected. Maintenance requirements are approximately proportional to the animal's weight.

Growth

Growing animals require nutrients for the production of new tissues as the bones, muscles, and organs of the body increase in size. Growth requires an abundance of protein, minerals, vitamins, and energy.

Milk Production

The milking doe requires nutrients for manufacturing the milk she produces. Milk is high in protein, minerals, vitamins, and energy. Requirements, therefore, are very heavy for these nutrients. The milking doe also requires a great deal of water for her body needs and for milk production.

Milk of the high butterfat content contains more nutrients than lower testing milk, and requires a larger quantity of nutrients for its production. Thus, most feeding guides are calculated for milk of various percentages of fat, and over a range of production.

Reproduction

The pregnant doe requires additional nutrients for the growth of the fetus (unborn kid), especially during the last two to three months of pregnancy. This is the period of most rapid growth of the unborn kid.

Fattening

The nutrients needed for fattening are those supplying energy. This will include carbohydrates, fats and any protein not needed for other purposes.

Work

Work requires energy and calls for the same nutrients as for fattening. We do not ordinarily use dairy animals for draft purposes, but when the goat is forced to climb over hilly, scanty pastures, or to walk long distances to and from the pasture, she may be using much of the energy she gets from her food for this work.

WHAT IS A RUMINANT?

What is the main function of the digestive system?

The main function of the digestive system is to digest or turn food into nutrients that are ready to be used and absorbed by the body.

There are several different types of digestive systems in animals. Each type is suited to the foods and behaviour of the animal it is a part of. All animals need the same kinds of nutrients to live, but different animals need different amounts. What differs is the type of food that each animal eats to get its nutrients.

The goat is a ruminant animal. This is why goats are able to eat grass, hay, leaves and branches which animals with simpler digestive systems are not able to eat. In fact, they enjoy eating very tough; fibrous plants more than most other ruminants. This is why goats can survive in areas that are not suitable for other livestock.

The goat is only one of many types of ruminant animals. Two farm animals that you might think of are the sheep and cow. Many wild animals are ruminants too. They include buffalo, deer, moose and antelope.

What do these animals have in common?

- all of them eat vegetation (plants).
- Most of them are quite large and must eat a lot to survive.
- Many of them would be prey for meat-eating animals (carnivores).

All of these clues might help you to understand why these animals are ruminants. All of them must eat quickly as they move about in search of food. They cannot spend a great deal of time chewing their food as they eat it. They wait until later to chew their food by regurgitating it from the rumen back into their mouths.

THE RUMEN IS LIKE A FACTORY

Ruminant animals digest the cellulose in roughage using microbes contained in the rumen (stomach). Microbes are the tiny life forms that break down plant material that has been eaten. They are very good at processing tough feeds like hay and whole grains.

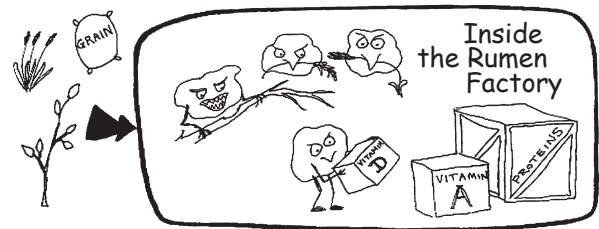

Ontario 4-H Council

The microbes turn the feeds into vitamins, proteins, minerals, and carbohydrates, for the goat.

THE PARTS AND WHAT THEY DO

The mouth ingests food and chews it into smaller particles. Saliva mixes with the food and begins the digestive process.

The esophagus moves the food from the mouth to the stomach by muscle contractions.

The rumen is the largest part of the stomach. It is also known as the first stomach or the paunch. Food enters and is agitated and partially digested by microbes.

The reticulum forms a cud (ball of food) and regurgitates it to the mouth for chewing. It is also known as the second stomach or the honeycomb because of its honeycomb appearance.

The omasum (oh-may-sum) extracts (removes) and absorbs fluids out of the food. This fluid contains nutrients. This is also known as the third stomach or the bible because its surface looks like the edges of pages of a large open book.

The abomasum (ah-bow-may-sum) contains digestive juices to digest food further. It is similar to our human stomach. In young goats, this is the

stomach that does most of the work when kids are drinking large quantities of milk. A special passage called the esophageal groove closes off the other stomachs when the kid is drinking so that milk passes by them and comes right to the omasum and into the abomasum for digestion. The abomasum is also known as the fourth stomach.

The small intestine is like a long pipe where more digestion takes place. Most fluids and nutrients are absorbed through the walls of the small intestine. Most nutrient extraction takes place here.

The cecum (see-cum) is between the small and large intestine. It contains more micro-organisms to digest food further.

The large intestine absorbs water and adds mucous to the remaining material to help it continue through the digestive system.

The anus is the opening though which undigested food is eliminated from the body.

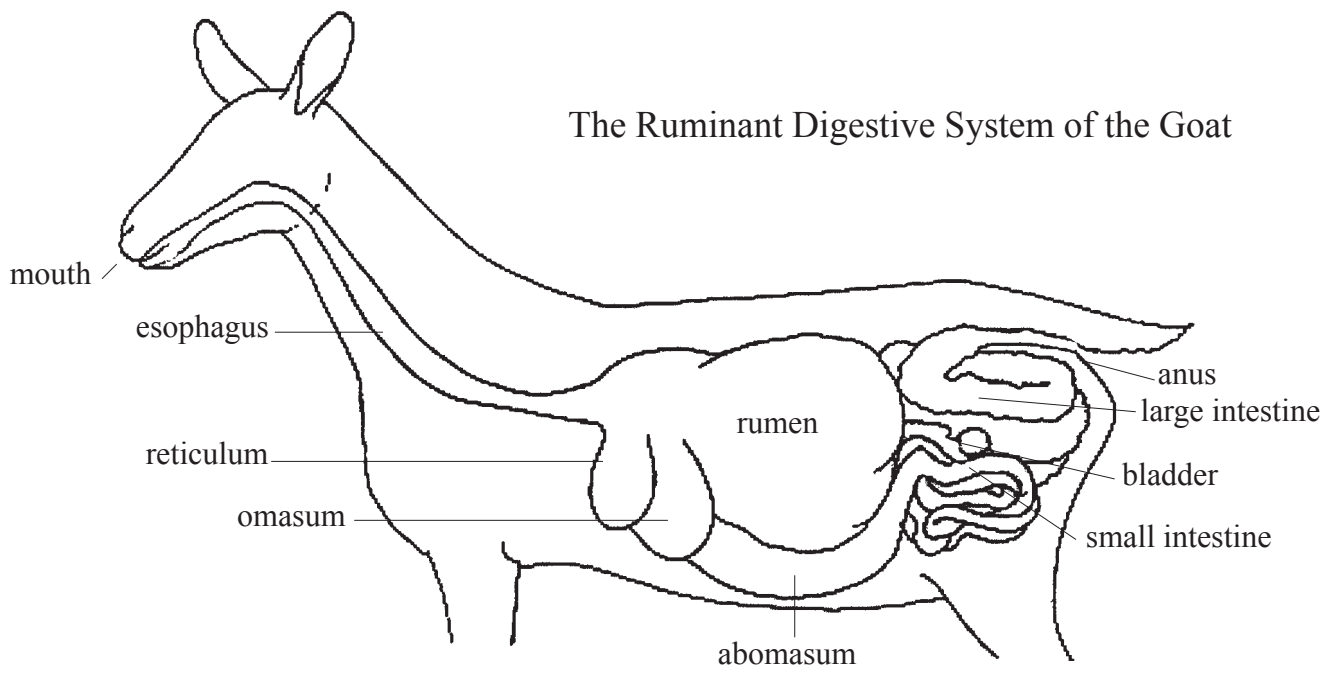

The digestive process is a little like a factory in which raw materials are refined into finished products. A good example is a pulp and paper mill in which logs are chopped up, boiled, fermented in chemicals and then compressed into paper.

The goat's digestive system is a complex "factory" which can process foods we cannot eat, like grass and hay, into milk or meat that we can eat.

We have to remember that the basic nutrients must be in the food the goat eats, so that it can turn these into energy and other products.

Is Water Important?

Often we don't think of water as a food. It is important? You be the judge.

Most of the contents in the digestive system of the ruminant are water. Food that is eaten is mixed with water so that it can move about through the digestive system easily.

Most of the goat's body is water. It forms a large percentage of my blood and body tissue. Without water, there would not be much left of a goat. Goat milk is composed of approximately 90% water. A goat needs water in order to make large quantities of milk.

Water is very important to the goat, as it is to all-living beings!

CLASSES OF FEEDS

Feeds can be classified into three main groups.

1. Concentrates
2. Dry Roughage
3. Succulent Feeds

1. Concentrate Feeds:

The concentrate feeds include farm grains; mill feeds and manufactured supplements. They are feeds low in fibre and high in digestible nutrients. They are able to supply large quantities of energy for the animal to use quickly.

Some of the common concentrates are: oats, barley, wheat, wheat bran, shorts or middlings, corn, molasses, dried beet pulp, linseed meal, fish meal, pea meal, cottonseed meal and soybean meal.

Several manufactured feeds for dairy cattle are on the market. They are mainly composed of concentrates to which minerals have been added. They are two main types:

- a) Complete concentrate rations – 14 – 18% protein fed directly.
- b) Supplementary Mixes – 24 – 35% proteins to be mixed with homegrown grains.

A 14 or 16% dairy concentrate ration is suitable for feeding to goats.

2. Dry Roughage Feeds:

The dry roughage feeds include such feeds as hay and straw. These are feeds, which are high in fibre but low in digestible nutrients. Large quantities of such feeds would be needed to sustain animal life. The stomachs of goats are designed for the utilisation of such feeds. They are part of all ruminant diets but it has been proven that animals can be raised in good condition on concentrate feeds without the use of roughages.

Dry roughages used for goat feed include alfalfa and clover hays (high in protein), mixed hay, timothy hay, meadow hay, and grain hay.

These hays differ considerably in the content of protein, carbohydrates, mineral and fibre. In general, hay containing a high proportion of legumes is most suitable for dairy goat feeding. Early cut or immature grasses and legumes may contain as much as twice the nutrient percentage as late cut, mature plants.

3. Succulent Feeds:

By succulent feeds we mean any feeds that are fed in the green or preserved stage – ensilage and green grass are examples.

Corn silage is one of the best roughages. It has a good effect on the digestive system of the animal. Corn silage can be used as a winter-feed or to supplement the ration when summer pastures are scarce.

Green silage refers to that made from grass, legumes, green cereals or combinations of these. It is considerably higher in protein and slightly lower in carbohydrates than corn silage.

Green feed, both legume and grass is the most economical feed for livestock. It is highly nutritious and palatable feed that supplies a great many of the food elements necessary for health and growth. It can, however, impart an unpleasant flavour in goats milk, and contribute to several diseases.

The Importance of Forage to the Goat

As we know, the ruminant animal can make very good use of roughage. The goat's digestive system works best on high fibre feeds. For this reason, farmers feed forage crops to their ruminant animals. The most common among these crops is hay and pasture.

RECOGNIZING QUALITY HAY

The key for choosing good hay is "QUALITY". Good quality hay is PALATABLE and HIGH IN NUTRIENTS! It is important that we know how to judge hay so that we can choose hay that is best suited for our animals.

Hay quality is judged using several different methods.

Appearance

There are many things that we can find out about hay just by looking at it.

- Is the hay nice and green or is it bleached out or even brown or black?
- Was it cut when it was young or just maturing or is it over ripe – the leaves, buds and flowers are gone with just the stalks left?
- Does the hay have the right combination of grasses or legumes we want?
- Is it full of weeds?
- Is there mold in the bales?



Ontario 4-H Council

Odour

Does the hay smell as if it would be good to eat? Does it smell like a freshly mown field (or your lawn when you cut the grass)? OR is it moldy or bad smelling; musty or dusty like an old barn?

Feel

Does it feel soft and tender? OR is it sharp and tough feeling?

Forage Analysis

Several laboratories are certified in the province to do forage testing for farmers. With forage testing equipment a sample is taken and then sent to one of these certified laboratories for analysis. The farmer is charged a fee for the nutrient analysis of his/her forage. Grain rations may be analysed in the same way. Knowing the exact nutrient content of your hay (through forage analysis) helps us to determine how much grain and mineral is required to meet the goats nutritional needs.

Using forage analysis, we can find out the actual nutritional value or content of our hay.

E.g. this sample of hay has:

Total Digestible Nutrient	?	
Crude Protein	?	
Calcium		?
Phosphorus		?

Storing Hay

Store baled hay inside a shed, or on dry, level, well-drained sites. Stack the bales to avoid wasted space and permit easy handling. Even large round bales must be set on a well-drained site. Crushed rock makes a good base for those bales. The bales will act like a sponge and soak up moisture from wet soil. More spoilage can occur on the bottom side of the bale from the top.

THE GREAT OUTDOORS

Goats can make use of many types of plants for food. One of the best ways to feed goats is to turn them onto pasture or brush to browse.

Browsing

Goats enjoy browsing. This means that they like to walk around nibbling off leaves and branches, flowers, tree bark and other plants. For this reason, marginal land can be used for feeding goats. Marginal land is land that is too hard to cultivate and seed with crops. This may be because it is too wet to plant, too rocky to cultivate, or the land may be very hilly and impossible to work with tractors. This type of land grows many plants which goats like to eat.



Ontario 4-H Council

Pasture Management

Pasture management means that you are providing good quality food for your goats while looking after the plants that produce the food.

In a well-managed pasture:

- The forage plants are tasty and interesting to the animal;
- The field is the right size for the number of goats;
- A field which is too small will become over-grazed and the plants will be killed as they are chewed off too close to the ground or stepped on by the animals.
- A field which is too big will not be grazed enough. The plants will grow too tall and be tough and tasteless.
- The type of plants grown provides good nutrition for the animals.

How to Manage a Pasture Well

- Divide pastureland into proper sized fields for the herd. This is often done with electric fences. For optimum pasture growth it is best

if animals are only allowed 3 to 4 days grazing in a paddock and then removed to the next. Each paddock should be rested for approximately 30 days before animals return to graze it. NOTE: It is important to know when animals are beginning to over-graze a field. The farmer must watch to see how much grazing the animals are doing. Grasses should never be grazed until all leaves are gone. Make sure that enough leaves remain for the plant to continue growing well (usually no shorter than 6 cm). Do not turn goats out onto a pasture until it is about 15 cm tall.

- Grow different types of forage. Different varieties of forage crops mature at different times (flower and go to seed). When the farmer plants a field, he/she can choose varieties of forage grasses and legumes that have different maturity dates. In this way, all fields will not mature at the same time.
- Take goats off a pasture that is growing faster than it can be eaten. The field can be cut for hay while it is still tender and nutritious enough to make good hay. Later, goats can be turned back into the field to eat the remaining grass.
- Make sure that pastures are fertilised well so that they will grow back well each year, being sure not to add too much nitrogen.

Poisonous Wild Plants

It can be very economical to pasture goats on land that cannot grow any type of cultivated crop. But, before we turn goats onto uncultivated land, we must know that the plants are safe to eat. In British Columbia we have several plants that are very poisonous to livestock. It is important that you learn to recognise these plants and keep them out of your field.

Prevention of Poisonings

- Don't let fields become over-grazed. Goats may not bother with a poisonous weed at all but if there is nothing left to eat in the field, they will try eating these plants.
- Be careful not to harvest poisonous plants with hay.

- Keep goats out of fields until grasses are well advanced as many of the poisonous weeds are early growers.
- Destroy poisonous plants or fence off areas where they are found.

ALTERNATIVE FEEDS FOR GOATS

Other types of feed that can be given to goats are often overlooked. Goats like most grass clippings, garden thinnings, tree branches and windfall apples. Remember that we must be careful to feed only plants which are safe to eat. Be sure that anything you feed has not been sprayed with insecticides or herbicides. Don't use plants from roadside ditches as they are often sprayed with herbicides (weed killers). Remember, if you don't know for sure that a plant is safe to eat, do not feed it to the goats. Introduce all new feeds to your goat's diet gradually. Check with other producers about the rate of feeding.

WHY GOATS NEED GRAIN TOO

Usually, when goats are growing, pregnant or producing milk or mohair, they don't get enough nutrients from hay alone. This is because hay or pasture grass is very bulky (and takes up a lot of room in the stomach), and it takes very large quantities to fill the needs of goats with high energy demands. This doesn't mean that we should restrict the amount of hay or pasture a goat gets. Instead, let the goat eat all the hay or pasture that it wants, and supplement the diet with grain rations to supply more energy. The amount of grain you will have to feed your goat depends on the quality of hay.

CALCIUM, PHOSPHORUS AND OTHER MINERALS

Other nutrients found in hay can vary between types of hay. Animals need varying rations of calcium and phosphorus and other minerals. Goats require a diet in which calcium intake is slightly more than phosphorus intake. Some feeds are very high in one or the other of these minerals.

Phosphorus and calcium can be balanced by making sure that goats get both in their feed. Feeding both hay and pasture and a grain ration usually does this.

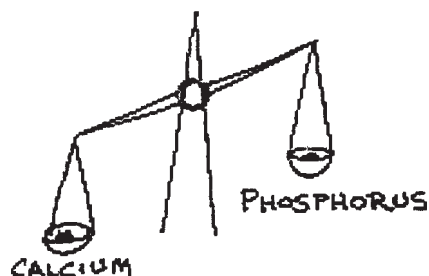

Other nutrients found in hay can vary between types of hay. Animals need varying rations of calcium and phosphorus and other minerals. Goats require a diet in which calcium intake is slightly more than phosphorus intake. Some feeds are very high in one or the other of these minerals.

Most types of forage (hay or pasture) are higher in calcium while most grains are higher in phosphorus.

Other minerals occur naturally in the feed goats eat and are usually in sufficient quantities to supply the goat's needs.

But, as a safeguard that goats do receive enough minerals (particularly salt), most farmers provide trace mineral salt licks and/or loose mineral mixtures. Minerals are also added to many commercial grain rations. This is how salt is often supplied in the goat's diet.

VITAMINS ARE IMPORTANT

Vitamins are a little like keys which unlock other nutrients so that they can be used by the goat's body. Most are obtained in the food that the goat eats, but a few are by-products of the microbe activity in the rumen during digestion (Vitamin B is one example). Some feeds have more of one vitamin than another does. By providing a variety of feeds, most vitamins are supplied in good quantities. Many commercial feeds have vitamin supplements (concentrated vitamins) added to help supply vitamin requirements.

Vitamins

All goats need a vitamin and mineral supplement.

<i>Name of Vitamin</i>	<i>Functions</i>	<i>Deficiency Symptoms</i>	<i>Sources</i>	<i>Comments</i>
Fat Soluble Vitamins				
Vitamin A	For bone growth, night vision, maintenance of epithelial tissue - respiratory, urogenital and digestive tracts and the skin.	Stunted growth, loss of weight, night blindness, nervous incoordination, sterility in males and females or young are born dead or weak	Vitamin A can be provided as the synthetic vitamin or as its precursor carotene sources - green leafy hays (not over one year old), grass silages, lush green pastures, carrots, whole milk, dehydrated alfalfa meal.	Vitamin A is found only in animals. Plants contain the precursor able to store considerable Vitamin A. Both Vitamin A and carotene are destroyed by oxidation.
Vitamin D	Aids in assimilation of calcium and phosphorus. Necessary in normal bone development including bones of the fetus.	Rickets in young, osteomalacia in adults.	Vitamin D ₂ - the plant form. Vitamin D ₃ - the animal form. Sun cured hays, irradiated yeast.	Most mammals can use D ₂ or D ₃ , however birds require D ₃ . Tissue storage of D very limited.
Vitamin E	An antioxidant. Muscle structure. Reproduction.	White muscle disease in calves. Reproduction failure.	Germ or germ oil of plant seeds. Green plants. Green hays.	Vitamin E widely distributed in all natural feeds. Utilization of Vitamin E is dependent on adequate selenium.
Vitamin K	Essential for prothrombin formation and blood clotting.	Prolonged blood clotting time, generalized haemorrhages, death in severe cases.	Menadione (K ₂). Green pastures, well-cured hays, fish meal. In general Vitamin K is widely distributed in normal animal rations. Also all classes of farm animals synthesize it.	Vitamin K has definite value in humans.

<i>Name of Vitamin</i>	<i>Functions</i>	<i>Deficiency Symptoms</i>	<i>Sources</i>	<i>Comments</i>
Water Soluble Vitamins (B-Complex)				
This group includes thiamine, niacin, biotin, riboflavin, pantothenic acid, para-amino benzoic acid, pyridoxine and vitamin B12. The group of vitamins is essential; however, the goat is able to utilize the B-complex vitamins that are produced by rumen microorganisms. Also many normal feedstuffs are good sources of the vitamins in this group.				
Vitamin C	Collagen formation. Formation of the intercellular substances of	Scurvy; swollen, bleeding and ulcerated gums; loosening of teeth and	Ascorbic acid, citrus fruits, green pastures, well-cured hays.	In farm animals, ordinary farm rations and body synthesis provide adequate Vitamin
C.	the teeth, bones, and soft tissues. Increases resistance	weak bones.		

UREA – WHAT IS IT?

Urea is nitrogen that is not a protein. Ruminants, including the goat, can turn non-protein nitrogen into protein through the microbe activity of their rumens. Urea cannot be fed alone as the microbes must also have carbohydrates from other feed sources in order to use the urea to make protein. Urea is toxic if not properly fed to goats. Feeds containing urea should not be fed to very young goats. Most farmers do not give urea feeds to their goats. Goats must adapt slowly to a urea ration over a period of at least three weeks, if it is to be introduced to their diet.

FEED LABELS – WHAT DO THEY MEAN?

When we purchase mixed grain rations, the bag will have a label attached to it. The label will look something like the following example.

The label will have the name of the company which prepared the feed.

The name of the type of ration (what it is made for - the type of animal it is fed to).

The registered patent of ingredients.

Name of Company

Type of Ration

Registered Patent

Cautions

Guaranteed Analysis

PROFESSOR BILL'S FEED COMPANY	
SUPER GOAT 16% DAIRY RATION	
PATENT #0000000007	
This feed contains selenium added at a level of 0.20 mg/kg.	
—————	
GUARANTEED ANALYSIS	
Crude protein (min)	16%
ECP from NPS (max)	0.0%
Crude Fat (min)	3.0%
Crude Fibre (max)	6.0%
Sodium (actual)	0.20%
Calcium (actual)	0.8%
Phosphorus (actual)	0.6%
Vitamin A (min)	8,800 IU/kg
Vitamin D (min)	2,200 IU/kg
Vitamin E (min)	8.8 IU/kg

If selenium is added, it will be marked along with the rate it is added at. If antibiotics are added to the feed, this will also be marked.

The “Guaranteed Analysis” tells us what the nutrient content of this feed is. It is guaranteed to include the nutrients stated on this label.

ECP from NPS means, “Equivalent crude protein form non-protein nitrogen sources.” This feed has 0.0% (none). NPS is usually a feed additive known as urea.

NUTRIENT CONTENTS OF DIFFERENT FEEDS

You might be interested in knowing more about the nutrient contents of some different feeds that are available in British Columbia. An example has been included. This chart has average feed analysis figures for a sampling of grain, hay, haylage and silage from across British Columbia.

The figures may help you to identify which feeds contain more of some nutrients than others do. Pay particular attention to the columns marked “Ca” for calcium and “P” for phosphorus. Note that the hay, haylage and silage have much higher levels of calcium than phosphorus. In contrast, most of the grains have much more phosphorus than calcium.

Feed Type	Average Analysis on a DRY MATTER BASIS												
	NUTRIENT												
	DM	TDN	CP	Ca	P	K	Mg	Fe	Mn	Zn	Cu	Mo	Se
	%						ug/g						ug/kg
Grass Hay	88.4	55.9	10.3	.47	.23	1.81	.20	147	113	26	7.0	3.5	116
Grass Legume Hay	87.3	54.2	11.8	.87	.22	2.06	.24	133	59	24	8.7	3.1	126
Alfalfa Hay	88.7	57.0	16.4	1.33	.27	2.47	.28	251	35	23	9.7	2.6	189
Cereal Hay	86.4	60.9	9.3	.37	.26	1.95	.18	194	55	26	7.8	2.4	33
Barley Grain	88.6	81.4	11.2	.11	.38	.53	.15	119	22	45	11.0	1.7	60
Oats Grain	87.7	76.9	10.9	.10	.34	.70	.13	79	48	37	7.8	2.4	35
Grass Silage	35.1	53.3	12.6	.57	.40	2.47	.30	352	124	35	9.1	2.6	54
Grass Legume Silage	34.4	53.3	15.5	.93	.26	2.28	.25	287	76	31	8.7	3.2	155
Corn Silage	29.6	63.9	8.8	.36	.24	1.29	.20	213	47	29	7.0	1.7	78
Cereal Silage	38.2	63.4	9.1	.39	.28	1.61	.19	283	66	32	7.1	2.5	105

FEEDING GUIDELINES FOR GOATS

Goats are natural browsers. However goats cannot always be provided with their natural diet, so you must improvise to provide the goat the correct nutrition for its specific production. There are feeding guidelines that we can follow until we learn more about fine-tuning our feeding practices.

Items All Goats Need

1. Clean water at all times.
2. Free choice good quality mixed hay.
3. A loose mineral box and/or a trace mineral salt lick. Trace mineral salt licks are salt blocks with the trace minerals (cobalt, copper, manganese and zinc) added to them. They do not include any of the other essential minerals needed by the goat. They are placed in an area of the barn or

pasture where the animals can lick them when they want to.

4. A dairy ration is a mixture of different grains and is usually 16% protein. Goats need different amounts of this ration, depending on their age and sex. The table below gives examples of amounts needed.

KID -A kid is a young goat (male or female).

Most kids are weaned (taken off a milk diet) by three months of age. Kids would be eating hay and grain very well by this time. Hay should be mixed grass/legume hay and should be available at all times. Kids should receive approximately 2 kilograms of grain per day.

Protein Requirements: 12% protein between weaning and 7 months
9% protein from weaning to age 1 year

DOES - A doe is a female goat.

YOUNG BRED DOES

Gradually increase grain ration to one kilogram per day during the last four weeks of gestation. If you think a young goat is carrying twins or triplets, the grain could be increased even more. Be sure that hay is a grass/legume first cut hay.

OLDER BRED DOES

Grain ration will have been cut back before the doe was dried off. Switch to a grass/legume first cut hay after the doe is dry. When does are dry, if they have access to good pasture and browse, they need no concentrate; if however, the pasture is poor or shows signs of drying, concentrate up to 0.5 kg per day should be fed.

Increase grain to 1 kg per day during the last two weeks of gestation. Pay attention to does that have a past history of large multiple births (triplets and quadruplets). They may require extra grain. The actual amount of grain fed should be based on nutrient content of hay, which has been determined through a forage analysis.

MILKING DOES

Dairy goat ration is available. A large proportion of succulent feed or beet pulp may be added to the ration, if available. To milk well, does must be fed well. Rations for does should have a protein content between 12 and 16 percent depending on the amount of protein in their hay and on their milk production. A good rule of thumb is to feed 1.5 kg of grain for each 3 kg of milk produced daily, and to provide a minimum of .75 kg daily for low producing does. Hay can be of high legume content once the goat is milking. It is a good idea to continue to feed a good quality mixed hay once a day even if you feed a second cut legume hay as well. Goats enjoy the variety and the extra roughage is good for their rumen.

Protein Requirements: 9% protein when dry

12 – 16% protein when in
milk

THE “VERY HEAVY MILKER”

The very heavy milker must be managed with great care. By “very heavy milker”, we mean a goat which gives over 5 litres of milk per day. Increase the grain ration to keep up with her production. To keep her appetite strong, make sure that the amount of hay she eats never goes below 40% of the total weight of feed eaten (grain and hay). This will also ensure that weight loss associated with early lactation will be gradual and remain at an acceptable level. Many of these heavy producers will lose weight rapidly if you do not feed them adequately.

CHALLENGE FEEDING

This system is often used when feeding heavy milkers. The farmer increases the gain a little each day after freshening. The milk should be weighed every day. The grain is increased until the milk production does not increase in response to the extra grain. The grain can then be cut back a little. The farmer watches for any drop in production and increases grain if necessary. This is an effective way to feed heavy producers if you are careful and keep a close watch on the production of the goat at all times.

A satisfactory ration for the milking doe is:

Clover or alfalfa hay	1 kg a day
Corn Silage or roots	.75 kg a day
Concentrate mixture	.5 to 1 kg a day

An alternative ration where no silage or roots are available is:

Clover or alfalfa hay	1.5 kg a day
Concentrate mixture	.5 to 1 kg a day.

When the does are on pasture, the concentrate mixture may be reduced a little. Grass, especially young grass, is an excellent feed and it replaces up to half the concentrate.

A good grain (or concentrate) mixture containing 13.5 percent of digestible protein would be:

Crushed oats	75 kg	low protein
Cracked corn	75 kg	low protein
Wheat bran	25 kg	medium protein
Soybean oil meal	25 kg	very high protein
Salt	2 kg	

It is best to feed the does separately so that each doe gets her proper ration. The amount of concentrate should be increased according to the amount of milk given.

BUCKS AND WETHERS

A buck is an intact male goat and a wether is a castrated male goat.

Bucks do not need to be fed alfalfa hay. Good quality grass or mixed hay meets their nutritional needs. If alfalfa hay is fed, limit it to 1 kilogram a day to avoid high levels of calcium in the diet. Mature bucks can develop arthritis due to excessive calcium deposits in the bones and on the edges of the joints – emphasising the importance of “balanced mineral levels” in the ration. In other words, avoid feeding too little or too much of any nutrient. Keep the calcium to phosphorus ration between 2:1 and 3:1. Using horse vitamins and/or a mineral mix added to the grain will help accomplish this. Grain must be one with low phosphorous. Read the ingredients on the feed tag. For bucks and wethers who need more fat and muscle on them feed a supplement that has about 30% fat and 16% protein. A 23-kg animal only needs about 5 ml (1 teaspoon) of this supplement daily.

Protein Requirements: 9% protein

Young bucks should receive 2 kilograms of dairy ration per day. Older bucks should receive ¼ to ½ kilogram of ration per day. During the breeding season it is very important to increase the grain a little, approximately .25 kg. The natural breeding season for goats is usually from late August through to early March. It is useful to know that many bucks lose their appetite in breeding season; they won't eat their grain and just knock their dish over.

OTHER SITUATIONS

“Flushing” Before Breeding Season

Goats are usually “flushed” before breeding season. This means that they are fed at a higher nutrient level (more grain, better pasture) as this increases reproductive performance (multiple births). It is particularly important to flush younger

goats that are not milking and does in the meat herd. In the dairy herd the does are receiving grain while they are milking and will be bred while they are still lactating. In the meat herd, the does will probably have been dried off after their kids were weaned. They will have been receiving minimal grain. Flushing will raise their condition a little and increase multiple births.

THE “MEAT HERD”

After freshening, breeding age females are fed for heavy milk production. Their kids stay with them to nurse. When the kids reach market weight (usually 2 to 3 months of age), they are removed from the doe. The doe should have a reduction or no grain until she dries off. The farmer wants the goat to be dry so that she isn't consuming much feed. She will also come back into heat sooner so that she may be bred for more meat kids.

THE “ANGORA HERD”

Angora goats have higher nutritional demands than dry goats. This is because they grow hair very quickly and hair requires many nutrients, particularly protein. The grain ration fed to Angoras is often 18% protein. If pasture or hay is very good, extra grain supplementation will not be needed. While alfalfa hay is very good for most Angoras, many breeders feed alfalfa pellets instead, as alfalfa hay gets into the goat's fleeces and is almost impossible to remove. Hay with more grass or clover hay is preferred, although hay with contains a large number of mature timothy heads will also easily contaminate a fleece.

Young growing angoras should receive 2 kilograms of grain per day. Older does may not need too much grain until they are in the last two months of gestation. They should then receive 1 kg per day gradually increasing to 2 kgs per day by kidding time. They should receive 12 kgs of grain per day while nursing kids. This should be eliminated as kids are weaned. Bucks do not need too much grain except in breeding season. A half a kilogram should be sufficient if hay is reasonably good quality.

Most Angora goats grow hair at the rate of 2.5 centimetres per month. that's about 30 centimetres per year.

MISC.

Should a goat go off its feed, an opportunity to browse the bark of brush sometimes helps to restore their appetite. Also, a dash of cider vinegar either on the feed or in water has been found helpful.

Goats are dainty feeders and the feed should be clean. They appreciate variety in the feed. It should hardly be necessary to add that goats need plenty of fresh water. They should not be allowed to drink from pools where the water has been standing.

GOOD NUTRITION BEGINS AT DAY ONE

When we make the effort to feed goats properly, we are rewarded with milk, meat or mohair.

THE BEGINNING ON DAY ONE

The goat kid is born! Like all new-borns, baby goats are born without resistance to many diseases and bacteria that are in its environment.

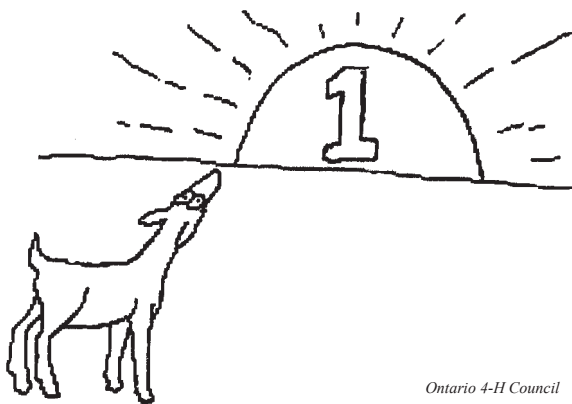

Ontario 4-H Council

The first milk a goat produces is different from regular milk. It is called colostrum. Colostrum is very thick and very high in nutrients. It also contains a special substance (antibodies), which gives the goat kid protection from disease and bacteria during its early life. As the young kid grows older, it eventually develops its own antibodies to disease.

Several times the body has had to fight off bad bacteria and viruses that cause sickness.

Older goats now have antibodies in their blood, which recognise bad bacteria when they see them. They get together and attack them at the first sign of trouble.

The mother passes along some of these antibodies in the colostrum milk so that the new-born will have a way to fight bad bacteria until he or she is strong enough to make his or her own antibodies.

In order for the new-born goat kid to get the protection from the colostrum, it is very important for the kid to nurse as soon after birth as possible. If it waits too long, its stomach cannot absorb the antibodies properly. For the first several days it should drink every 3 to 4 hours (about 100-150 ml per feeding).

YOUNG KIDS

After 2 or 3 days of age, kids should be fed about 250 ml 4 times a day if possible. After a week, they can be fed 3 times per day, up to 500ml per feeding as they grow. At 3 to 4 weeks old, they may be fed 2 times per day and the milk can be increased to 750 ml (or more) per feeding.

Kids should also have access to a creep feed ration from one to two weeks of age on. Most creep rations are 18% crude protein. Very soft, tender, palatable hay should also be offered. Salt licks and water should also be made available. Be careful to remove soiled or uneaten food from the creep feeder at each feeding.

The first few weeks are very important ones in raising a kid. Proper care will get your kid off to a good start. Young animals make more economical gains in weight than older animals. For this reason, it pays to start goats properly and to keep them growing rapidly.

The feed for your young kid must provide:

- 1) Plenty of protein. Young kids require high protein feed to allow rapid growth of body tissues. As they become older, less protein is required.
- 2) Protein of good quality. This means the kind of protein, which is suited to the body needs of the animal. Milk provides the best possible kind of protein. When milk is fed, little thought need be given to the quality of protein the kid receives. If milk is not fed during the early period, the grain or concentrate ration should contain good quality protein.
- 3) Enough energy to permit normal growth. Kids also require energy to permit growth. Milk and grain are high in energy content. For this reason, kids should be fed milk and started on a little grain each day.
- 4) Enough minerals. Young animals require large amounts of calcium and phosphorous to permit growth of bones and teeth. Milk supplies large amounts of calcium and phosphorous and other minerals.
- 5) Necessary vitamins. Kids fed whole milk usually receive ample vitamins. Skim milk lacks some of the vitamins. You must see that your goat gets these from other sources.

The kid should be left with the dairy goat mother for not more than 12 hours. Allow the kid to suckle the mother after birth and from time to time up to 12 hours later but not more. Remove where the mother cannot see or hear kid.

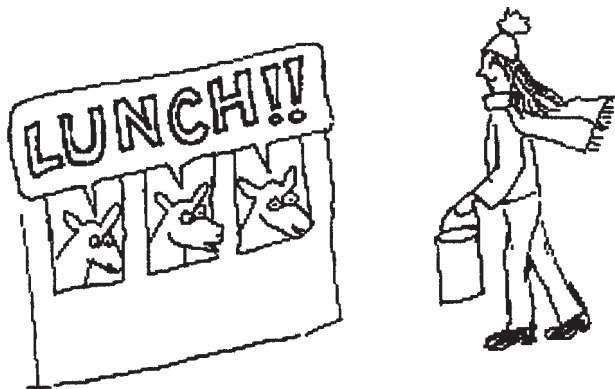

Ontario 4-H Council

How to Treat Colostrum

Colostrum milk is much more difficult to heat-treat when compared to pasteurising regular goat's milk. If it is heated too much, the antibodies are destroyed and it looks just like an omelette! This is because of the extra fat and other ingredients in the colostrum. We must take care in heating it properly.

Put colostrum in a heatproof container and place in water in the top part of a double boiler. Heat this gradually until the temperature of the milk is raised to 58°C. Have a thermos ready. Just before the colostrum is warm enough, rinse the thermos out with very hot tap water. When the colostrum is up to temperature, pour it into the thermos and put the cap on tightly right away.

Wrap the thermos in a towel and keep it in a warm place for one hour (you could wrap the thermos in a heating pad instead). After one hour open the thermos and check the temperature of the milk. If you have heat-treated correctly, the temperature should still be a 58 degrees Celsius.

Pour the colostrum into ice cube trays and freeze. Pop the "milk" cubes out into a plastic bag and store in the freezer until needed. You might need extra colostrum if a doe is unable to produce any or enough colostrum. When needed, use 2 cubes (about 70-75 ml) and put these in a heatproof container sitting in hot water from the tap. Let sit until colostrum reaches 38 degrees Celsius. Feed to kids as soon as they are born. Kids should have heat-treated colostrum for their first three or four feedings (in first 24 hours) if possible. Use three cubes (about 100- 150 ml depending on appetite) for the second and remaining feedings of colostrum.

Pasteurisation of Milk

Once the goat's colostrum milk is gone (about two days after kidding), her regular milk may be pasteurised. To pasteurise:

- Strain milk to remove any dirt particles
- Put milk in a heavy pot or top part of a double boiler.
- Heat slowly to 72 degrees Celsius.
- Hold at this temperature for 30 seconds.
- Place the pot of hot milk into a sink filled with cold water to cool it down as quickly as possible.
- Refrigerate and use as needed.

You may just cool the milk down to 38 degrees Celsius and feed it to the kids right after heating.

Note: Pasteurisation of milk will destroy some of the vitamins contained in milk. Many goat breeders have found that it is a good idea to add a few drops of liquid vitamin supplements to the milk at each feeding. Liquid vitamin preparations are made for livestock and are made to be added to the animal's water supply. Mix the vitamins into the milk using the same directions as those for addition to water.

Alternate Milk Sources

Cow Colostrum

Because colostrum is so difficult to pasteurise properly, many goat breeders have chosen to use cow colostrum to start their goat kids. Most dairy cow owners have much more colostrum than is needed to feed their calves. A dairy cow farmer may be willing to give you the small quantity of cow colostrum needed to give to your goat kids for their first 2 or 3 feedings.

If you wish to use cow colostrum, remember the following points.

- Be sure that the colostrum is stirred up well before feeding. The cream in cow colostrum will rise to the top (unlike goat milk). If you take colostrum from the top of the bucket, it may be far too rich for the goat kids. This will result in serious digestive problems.
- Cow colostrum often seems a little too rich and thick for goat kids. Mix in a little warm water or some pasteurised non-colostrum goat or cow milk before feeding to kids.

Milk Replacers

After kids receive colostrum milk, they may be fed milk replacers if pasteurised goat milk is not practical. There are several different kinds of replacers available. One made for kids is usually better than the kind made for calves or lambs. Ask your local feed store to order it for you.

Be sure that the milk replacer is always mixed properly. Most goat owners mix the powder with a small amount of water first and then add the rest of the water to this mixture. The ratio of milk replacer to water may have to be adjusted slightly to prevent digestive upset in kids.

It is usually best to start goat kids on whole goat milk for the first two or three weeks after they are born. They can then be gradually switched to a milk replacer formula by increasing the amount of replacer and decreasing the whole goat milk in the mixture.

PAN FEEDING

In teaching to drink from a pan have a quite shallow dish or use a gravy strainer to prevent the kid burying its nose too deeply in the milk, again make the kid comfortable on your lap, a little trouble will be experienced in teaching to drink. If the kid

refuses, miss a feeding.

BOTTLE FEEDING

Many breeders prefer feeding kids from a bottle contending it is the more natural method as the action of sucking causes saliva to be mixed with the milk thus aiding digestion. Great care must be taken to clean bottles and teats used, they should be sterilised after each feed.

TUBE FEEDING A KID

Once in a while, an emergency situation may make it necessary for the goat farmer to tube-feed milk to a kid in order to save its life. This is only done when kids have become too weak to drink milk from a bottle or from their mother.

There is some danger of causing a kid to drown with tube feeding if it is not done properly. However, some people mistakenly believe that it is less dangerous to drip small quantities of milk into a weak kid's mouth with a syringe. This may be even more dangerous because the kid may be too weak to swallow properly. This milk ends up going into the kid's lungs where it can cause drowning.

If tube-feeding is done correctly, it is not dangerous and it may save a kid's life.

HOW TO TUBE-FEED

Assemble the following: A piece of soft plastic tube about 2/3 of a meter long (60 to 70 cm). A small amount of adhesive tape of any kind. A large syringe to hold milk. A small supply of milk (nice and warm). A rolled up towel or a pillow to support the kid's head.

Step 1

Warm the tube in warm water to be sure that it is soft and pliable. Remove the tube from water and shake it out to remove any large drops of water.

Step 2

Lie the kid on its side. Take the tube and lie it over the kid following the shape of its body down to the stomach area. With this in place, wrap a

small piece of tape around the tube at a spot even with the kid's mouth. (This will help you to know when the tube is in the right place after you feed it into the kid's mouth and down into the stomach).

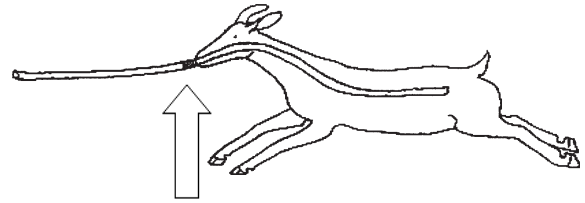

Lie tube over kid's body and mark spot even with kid's mouth. (use piece of tape)

Ontario 4-H Council

Step 3

(This step should only be done when actually necessary to tube-feed a kid and not just for demonstration purposes!)

Place the end of the tube over the kid's tongue and gently push it down its throat. (Be sure you are using the end of the tube intended to end up at the stomach – not the end you have marked with tape). Gently and slowly feed the tube down the kid's throat.

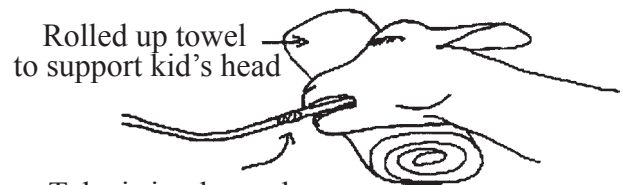

Tube is in place when the tape marker gets to kid's mouth

Ontario 4-H Council

You will find that the tube will probably slide down easily. When the tube doesn't seem to be going in any further, check it to see where the tape marker is. It should be quite close to the kid's mouth. You may wish to prop the kid's head up on a rolled up towel to make it easier to feed the kid.

WARNING! If the tape is much further up the tube, the tube maybe caught somewhere in the kid's windpipe or lung. To check tube's position, you can hold a piece of tissue paper or a tuft of cotton batting near the end. If air is coming thorough the tube, enough to make the tissue or cotton rustle, you are in the lungs! Gently remove the tube and try again.

When the tube is correctly positioned in the stomach, it is not unusual for some fluid from the stomach to come part of the way up the tube.

Step 4

Once the tube is in place, a syringe filled with warm milk may be attached to the end of the tube sticking out of the kid's mouth. Gently and slowly push the plunger of the syringe in to feed the kid. Do not push the plunger quickly because you may injure the kid by injecting milk too quickly into the stomach. Do not overfeed! Feed only a small amount of milk at a time (usually no more than 50 ml). If you are using a small syringe, you may leave the tube in place and refill the syringe and replace it to continue feeding. Some farmers leave the plunger out of the syringe and carefully pour a small amount of milk into the empty syringe.

Attach syringe filled with warm milk and slowly push plunger of syringe to feed.

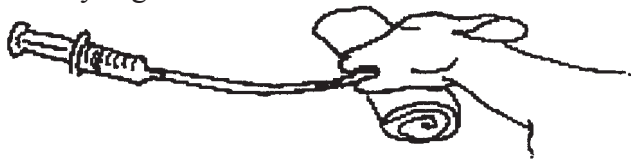

Ontario 4-H Council

Step 5

When you are finished feeding the kid, leave the syringe attached to the tube with the plunger pushed all of the way in. This will prevent any milk from flowing out of the tube as you remove it from the kid's throat. You do not want drops of milk to drip out of the tube near the kid's lungs

you remove the tube. After the tube is removed, wash the tube well in soapy water and let it dry well before storing it away in your medical kit.

After feeding: Leave plunger of syringe pushed all of the way in. Gently pull tube out of kid's body.



Ontario 4-H Council

HOUSING

To maintain good health, a goat needs a clean, comfortable environment in which to live. An environment is made up of all of the things that surround and affect the goat.

GOATS NEED SPACE

When goats are overcrowded, they often fight with one another over food, or a place to lie down when they want to rest. Goats that spend time fighting instead of eating and sleeping will not produce well. Shy goats that do not like to fight may not get very much to eat. To prevent problems, farmers must allow enough space for their goats.

Most goat farmers allow an area of at least 2.3 square metres (25 square feet) for each adult goat. Young goats require at least 1.4 to 1.9 square metres each (15 to 20 square feet).

TYPES OF HOUSING

Loose Housing

- Most common type.
- Goats are free to wander
- Goats get more exercise.
- Goats can socialise more.
- Aggressive goats can bully shy goats.
- Feeders and waterers can be quickly filled (saves on labour).
- Do not usually receive individual attention, cannot adjust feed individually.

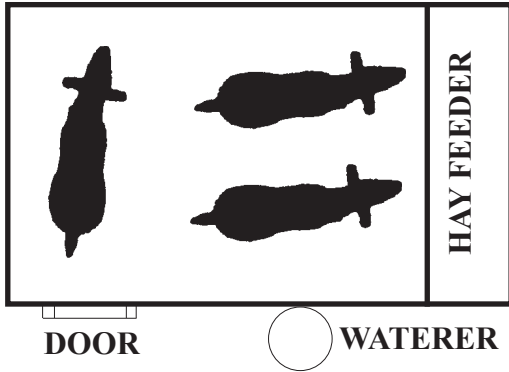

- Stalls can be set-up for cleaning with a tractor and loader.
- Few dividers so minimal cost and time in building the set-up.

Individual Stall

- Individual stalls for resting.
- Turned out together for exercise.
- Goats must be let out for exercise.
- Not much opportunity to socialize.
- Do not have to compete for food or living space.
- Feeders and waterers must be individually filled (labour intensive).
- Usually receive more individual attention, individualised feeding program can be used.

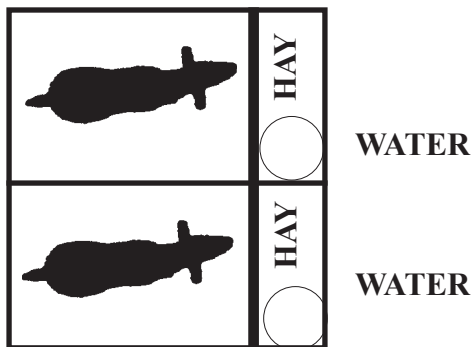

- Usually cleaned out by hand with a pitchfork and wheelbarrow.
- More stall dividers, doors, feeders and waterers so will cost more and take more time to build.

Building Stalls

A variety of materials such as steel piping or wood can be used to build box stalls, keeping in mind the following.

Individual stalls should be about 1.2-m (4-ft.) wide and 1.5 m (5 ft.) long for adult goats. Some goats like to jump out of their stalls, so the minimum height for box stall partitions should be 1.2 m (4 ft.). If a deep manure pack is allowed to build up, 1.5 m (5 ft.) may be a safer height. Alleys should be kept wide enough, 2.1 m (7 ft.), to allow for access of a tractor and scraper.

Goats like to try to stand with their front feet on partitions. However, it can cause lameness in the hind legs if a goat spends too much time standing with its front legs up on the stall divider. This is very common in bucks because they weigh more than does. Slats or bars of stall dividers should be vertical rather than horizontal to discourage goats from standing with front legs up on partitions. Because a collar can become snagged on anything that sticks up above the top rail, vertical slats should be flush with the top rail of all partitions.

Solid stall walls can be made using plywood or wooden planks. Solid walls are more difficult to escape from and will help to prevent drafts at floor level. But goats cannot see out of the stalls, so at least one wall of the stall should have vertical slats or rails.

Stall doors should be hinged to swing outwards, otherwise bedding can become piled up against the doors, making it impossible for them to swing inwards. All latches should be "goat-proof." Use one of the heavier sliding bar type fasteners that a goat would find difficult to move with its nose or hoof.



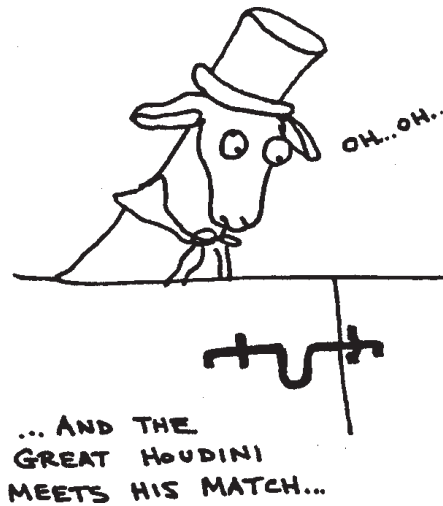

Ontario 4-H Council

Stall Floors

The best type of floor for the goat stall is an earth floor, covered with clean sand. An earth floor provides a good base, but allows moisture to drain away through the sand. It is usually less cold than a concrete floor and concrete usually traps dampness and urine, thus creating irritating odours and humidity. Wooden floors are not usually desirable because wood rots when exposed to dampness in the bedding.

All floors should be constructed so that they slope away to an area that can be drained. This is important when using a concrete floor because moisture can not drain away through the concrete. If the floor is slightly lower on the end near the waterer or waterpails, this will help to confine water spills to one area of the stall.

Concrete is best used in aisles, milk rooms and feed rooms. It is level for the farmer to walk on. Feed carts and wheelbarrows can easily be pushed across it. Concrete is rodent-proof and can easily be washed down and disinfected when necessary. If concrete is used as a floor, it should be poured over crushed stone. Any room that will be washed down (such as a milk room) should have some type of floor drain installed beneath.

Stalls should be cleaned often in summer months.

Bedding may be allowed to build up in winter months. In individual stalls bedding should be piled higher at the front of the stall since goats prefer to lie uphill. Concrete floors should be washed with a stable disinfectant after cleaning out. Earth and sand stalls may be deodorised by cleaning them out, allowing them to dry for a few hours and then sprinkling a dry stable deodorant (available at most feed stores).

When using stable lime as a deodorant/disinfectant care should be taken. Be sure animals aren't in the building at the time of application as it can cause serious respiratory problems if goats breathe it into their lungs.

Stalls for Bucks

Bucks should be housed separately from does. During breeding season, bucks will try very hard to escape from their stalls. A buck can easily damage particleboard or aspenite walls so think strong! Stalls should be made of welded steel, or of strong planking or thick plywood.

Buck stalls should be at least 2.4 metres (8feet) by 1.5 meters (5 feet). Bucks need lots of exercise, so locate their stalls next to an exercise yard so they can be turned out daily.

Pregnant Does

Pregnant does need plenty of exercise to be physically strong at kidding time. If they are confined to small pens, access to an exercise yard is a necessity.

Pregnant does that will soon give birth should be kept in a maternity or kidding pen. Such pens should be 1.8m x 2.4m (6 ft x 8 ft) and kept very sanitary to protect the kid and doe from disease. Whitewashing pens and walls helps maintain sanitary conditions. Before putting the doe in the pen, remove all manure and clean the pen thoroughly with barn detergent and water. Add a deep layer of fresh clean bedding.

Remove or place water pails high enough so the kid cannot be dropped in and drowned during kidding.

Kid Housing

Kid housing must be clean, dry, draft-free, and allow for plenty of exercise. In a 1.2m x 2.4m (4 ft x 8 ft) pen, there is enough space for four kids, two weeks of age. At four months of age, they should have 1.5m² (15 ft²) which could be reduced if they have access to an outdoor yard. It's a good idea to have no more than five kids per pen for management purposes. Toys in the stall will encourage exercise. Some possible toys are:

- One or two soccer balls to push around.
- A tin hanging from a rope.
- One or two strong wooden boxes.
- A wooden box with a long board nailed to it to make a ramp.

Kids wet and soil bedding often, so check that the bedding is not wet beneath the surface. Many disease problems occur when kids are in damp, unsanitary conditions.

A good kid pen has:

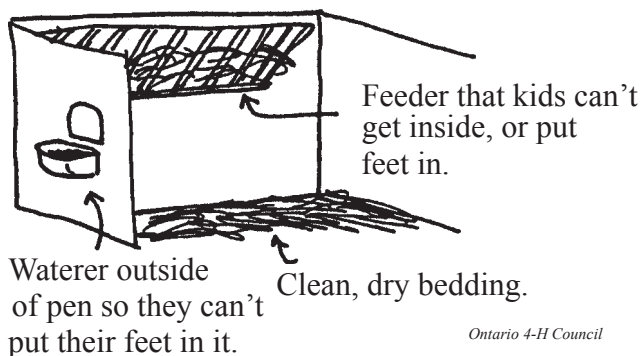

A poor kid pen has:

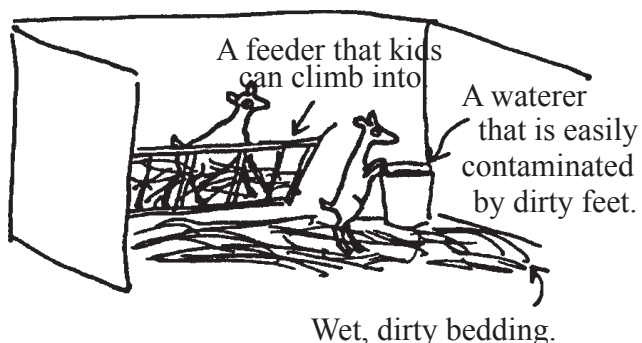

Hospital Stall

Larger goat farms should have a stall that is reserved for goats that are recovering from illness. This stall should be used only for this purpose. It should never be used as a maternity stall. The stall should be at least 1.5 metres by 1.5 metres (5 ft X 5 ft). Locate it in a quiet part of the barn away from other goats. After each use, the stall should be cleaned out and scrubbed down with disinfectant. Water buckets and feed tubs should be washed and set aside for use only in this stall.

Feeders and Waterers

Mangers, waterers, gates and dividers should be located in the barn where they will be most useful and to minimize walking and carrying of feed and water.

Feeders and Mangers

Goats should have a hay feeder that is placed off the ground so that it is difficult for goats to climb into or onto them (young goats like to squeeze through the bars of a feeder). When goats can stand up on feeders or waterers, they could contaminate the feed or water with urine, manure or earth stuck to their feet.

Goats can be picky eaters and if the feed can easily be removed, a lot of feed may be dropped to the ground and wasted. A feeder with slats will allow the goat to take out small mouthfuls at a time. Provide enough feeder space so less aggressive goats can always find room and build feeders so that goats cannot become trapped or strangled by them. Sometimes, especially at crowded feeders, two goats will put their heads into the same feeding slot and one or both will get choked. The "throat height" of feeders is important to minimize wastage. The proper height for does should be 38 to 46 cm (15 to 18 inches); kids should be 20 to 25 cm (8 to 10 inches).

You may wish to build your hay feeder with a tray along the bottom where grain can be fed. The grain

trough also helps to reduce hay wastage, as it catches the finer, leafier parts that would otherwise fall to the floor and be wasted. However some goats like to stand on these types of trays and can get the tray dirty. You will have to plan to scrape out the tray regularly to remove stale feed, manure or dirt.

Grain is usually fed in a bowl while the goat is being milked. If it is fed to the goat in the stall, it should be fed in a bowl that cannot be easily overturned. Most feed stores sell a very heavy black rubber fed tub that is difficult to overturn. After feeding, these tubs should be removed from the goats' pen so that they stay clean. They should be washed regularly using dish detergent or milking equipment detergent and a toilet brush makes an excellent tool for scrubbing out buckets.

Waterers

Goats require lots of CLEAN water. Milking does need water to produce milk and if their water pails or automatic waterers become contaminated with manure or urine, they will drink less and as a result, milk production will be lower, and kids will be exposed to disease. Here are ideas for waterers that are difficult to contaminate.

Waterer with a step. A cement pad around the base of the waterer in a loose housing barn provides goats with a CLEAN place to put their feet when drinking. Goats would find it difficult to put their feet up on this waterer.

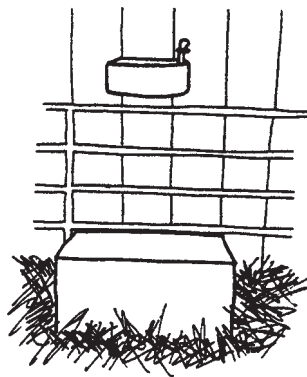

Ontario 4-H Council

Sometimes a waterer can be located outside of the goat pen. The goats can put their heads out to drink, but they cannot get their feet into the waterer.



Ontario 4-H Council

All waterers should be:

- Checked at least once a day to be sure they are clean;
- Checked to be sure they are working properly (if they are automatic);
- Located away from feeders where chaff, grain or hay could fall into the water;
- Located at the low end of the barn, to reduce dampness from spillage;
- Located to prevent contamination from manure and urine; and
- Thoroughly cleaned and scrubbed often.

If you use pails to water your goat, empty stale water twice a day and refill with fresh water. Goats will often refuse to drink stale water.

Barn Ventilation

Fresh air is necessary for good health. Good ventilation is one of the main components (parts) of good barn environment. Fresh air prevents the build-up of odours and high humidity (moisture content) in the air, which can cause many serious health problems in goats.

A barn with warm, humid air will provide the ideal conditions for growing harmful bacteria. Also, stale air contains carbon dioxide and ammonia. Carbon dioxide is produced when all animals exhale. Ammonia is contained in the urine of animals. At some time, most of us have smelled ammonia odours in a barn – this is the sharp odour that can make it difficult to breathe. Goats find ammonia just as irritating as humans do. Good ventilation will remove odours, stale air and moisture, and replace these with fresh air.

Ventilation is a tricky business. When air is moved in and out of a building, it can cause drafts that can chill goats and cause health problems. A good ventilation system brings air into and out of the building in a controlled way. It should also enter and exit at a level above the goats rather than at floor level.

These are some of the ways to provide fresh air while avoiding drafts:

1. The use of windows that are hinged at the bottom so that they open outwards at the top.

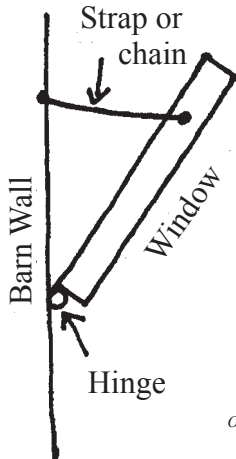

Ontario 4-H Council

2. The use of ventilation inlets at the top of the walls (such as between the roof trusses). Air can exit at the top of the roof through a covered ventilation outlet.

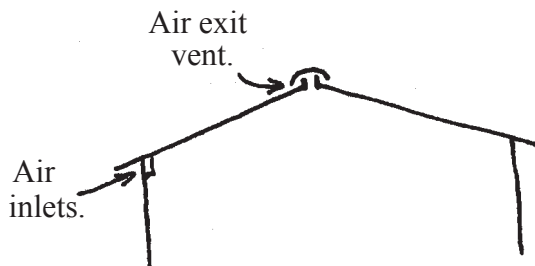

Ontario 4-H Council

3. A barn with a single pitch roof (sloped in only one direction) can be ventilated by leaving ventilation inlets and outlets at the top of the walls between trusses.



Ontario 4-H Council

4. If you are using windows or doors to ventilate a building, try not to create a "wind tunnel". This happens when a large amount of air can flow directly into and out of a building through large openings. For example, this diagram shows a barn with a large door on each end of the central aisle. If these doors are left wide open, a very strong wind will blow through the barn. A strong wind blowing along the barn floor will pick up dust and chaff and blow this into the goats' stalls. Dust and chaff can cause eye, respiratory irritations. Also, a strong wind could also chill goats if the weather is cool.

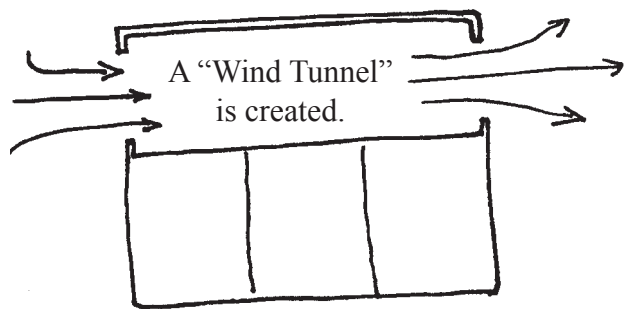

Ontario 4-H Council

A better way to ventilate this barn would be to leave one of the doors partly opened, and to open a side window instead. Or, you could close the door on the leeward side (the side away from the wind) most of the way so that it will limit the air that can flow out of the barn. This will limit the air that flows into the barn

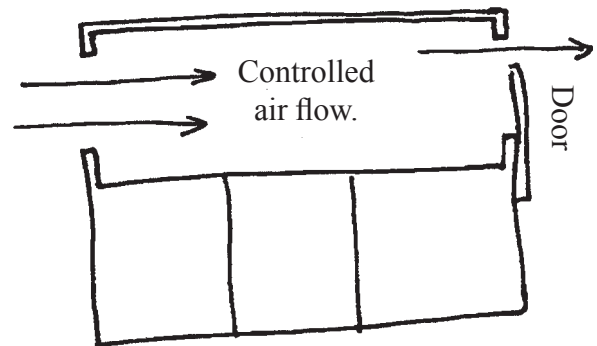

Ontario 4-H Council

HEALTH & DISEASES

Goats are usually quite healthy animals. But, like humans, goats do become ill from time to time. Most of the illnesses that affect goats fall into one of three categories – Infectious, Nutritional (Metabolic) or Parasitic.

Infectious:

- usually contagious
- caused by bacteria, virus or fungus
- examples: ringworm, pinkeye

Nutritional (Metabolic)

- not contagious
- cause by either too much or too little of a nutrient in goats' diets
- examples: ketosis, milk fever, white muscle disease

Parasitic

- somewhat contagious
- caused by small species of animals (parasite) that live on or in other organisms
- examples: coccidiosis

Prevention of Diseases

“A gram of prevention is worth a kilogram of cure.” Most farmers know that many diseases can be prevented through good management practices.

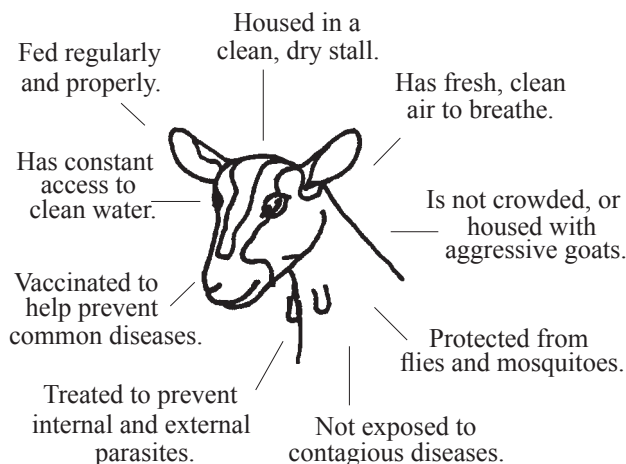

1. Keep Clean

Keep stalls, feeders and waterers clean and dry. Air should be fresh and not too humid. This can prevent the growth of bacteria and viruses that cause disease.

Example: The organisms that can cause mastitis often live right in the goat's stall. Under the right conditions, these organisms invade the goat's udder and cause a serious infection. Cleanliness helps to limit the number of parasites that can infect a goat. These can be external parasites (those on the skin), and internal parasites (those that live inside the goat).

How To Do It

- From spring through to fall, clean out stall at least once or twice a week.
- Do not allow stalls to become damp.
- In winter, you may allow bedding to build up into a deep litter to hold the warmth, but be sure that the stall is clean and dry on top. Clean stall out completely before springtime and fly season.
- Make sure that barn is properly ventilated to remove odours and stale air.
- Build feeders and waterers so goats can't get feet into the food or water.
- Scrape or sweep the walls and ceilings once or twice a year and follow with a good coat of whitewash.
- Keep the yard graded up so the water will drain away quickly and scrape up accumulated manure and take it to the field frequently.

2. Keep Flies Under Control

Flies can spread diseases by walking on one surface and then walking on another

Example: A fly can spread an eye infection such as “pinkeye” by walking on the eye area of an infected goat, and then flying to another goat's face.

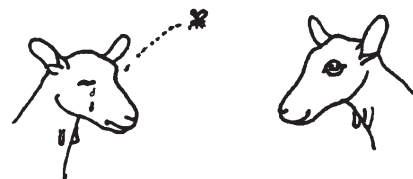

After

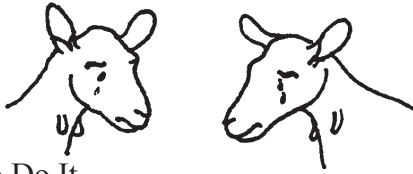

How To Do It

- Locate the manure pile well away from the barn or pasture.
- Wash down all milk spills in the barn immediately after they happen.
- Put screens on all windows and air vents in barn.
- Hang up flystickers from barn ceiling
- Keep stalls clean – especially during fly season.
- Try a trap that uses a fly attractant mixed with water to attract and kill flies. Flies go into the trap and are drowned without the use of pesticides.
- Repellent-treated ear tags are sometimes used for goats. They are fastened to the goat's collar. If a tag was inserted into an ear another goat could pull on the tag and rip the ear. Be sure to use tags approved for use on dairy animals, if you are using them for milking goats.

3. Proper Feeding and Watering

Improper feeding and watering causes many diseases. “Improper” can mean poor quality feed irregular feeding times, and sudden changes in quantity or type of food. All of these things can disturb the delicate balance of good bacteria that live in a goat's stomach and help to digest food.

Example: Moldy or dirty feed can cause several deadly diseases such as listeriosis (circling disease) or polio. Poisonous molds or bacteria can grow in moldy hay or grain. The goat eats the feed and becomes very sick or may even die.

How To Do It

- Select regular feeding times.
- Make all feed changes gradually.
- Turn goats out onto pasture only after letting them become accustomed to the rich grass over increasing periods of time each day.
- NEVER feed moldy or dirty feed. Moldy hay should always be discarded – a bale of hay costs a lot less than a new goat.

- Supply good, clean water. Avoid stagnate pools and streams or wells that are contaminated with seepage from the barnyard as sources of drinking water.

4. Control Parasites

External parasites such as lice or mites like to bite the goat's skin. This can be very uncomfortable for the goat – just like when you are bitten by many mosquitoes. Internal parasites live in the goat's body in areas such as the digestive system and the lungs. These internal parasites can be either one of many type of worms, or they can be microscopic parasites such as coccidia. Almost all parasites feed on the goat's body and drain away nutrients. In large enough numbers, most parasites can kill the host (the animal that they live on).

How To Do It

- Keeping your goats clipped in the summer can usually discourage external parasites. In the winter, a dusting with rotenone powder will usually kill most external parasites. Ivermectin wormer (given as an injection, or orally) also kills many of the blood-sucking types of external parasites.
- Using certain types of worm medications controls internal parasites. Before worming, it is best to collect droppings from your goat and have these analysed to find out which worms are causing problems. Your veterinarian can then help you choose the best medication to do the job properly.

Stomach Worm's Life Cycle

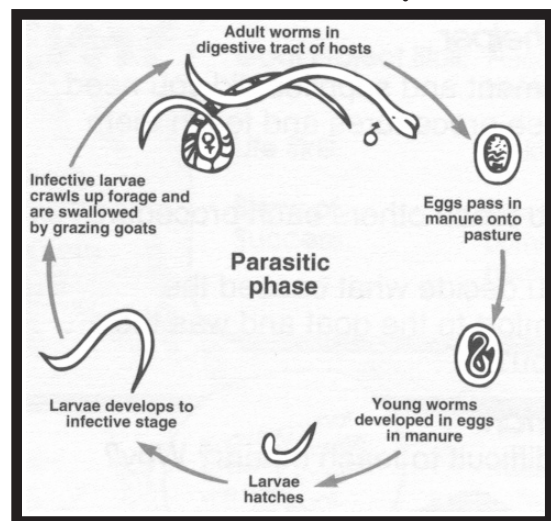

5. Keep Goats Properly Groomed

As mentioned, clipped hair will discourage external parasites in the summer months. Poorly trimmed feet will cause joint problems in the goat's legs: also, untrimmed hooves can fold over the sole and leads to hoof rot – a disease that decays the hoof and cripples the goat. Hoof rot has a very strong and unpleasant odour. The sole of the hoof will usually be black and very soggy, instead of pink and firm (as it should be on a healthy foot).

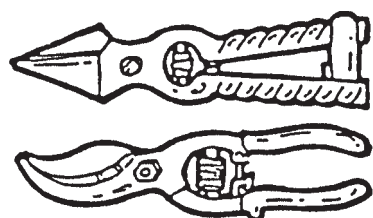
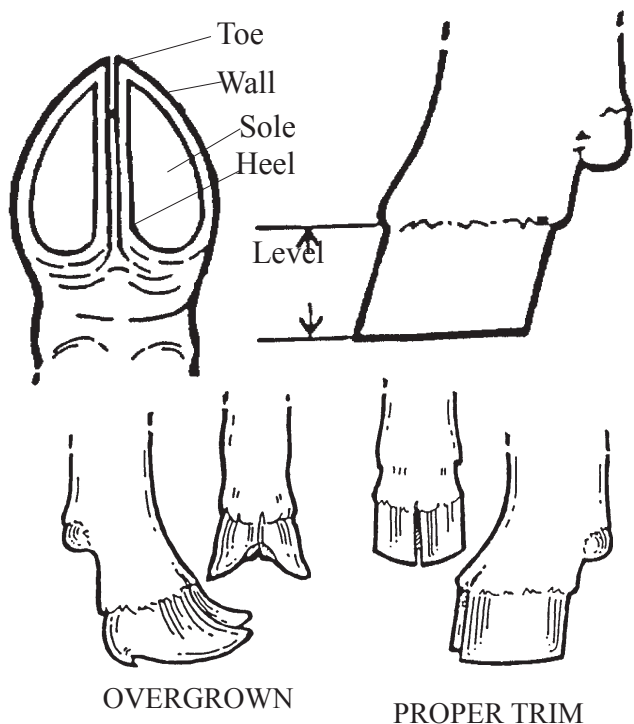

FOOT ROT
SHEARS
OR
PRUNING
SHEARS

How To Do It

- Hooves should be inspected and trimmed every 4 to 6 weeks. Trim hooves to the same shape as a four day old kid's. Hooves are much easier to trim when they are wet. The steps to trim hooves are:
- securely restrain the animal
- clean the dirt from the hoof

- carefully trim the walls of the hoof to the level of the sole
- trim the heels so that they are level with the ground, the sole should be almost the same as the hairline at the top of the hoof
- occasionally trim the dewclaws

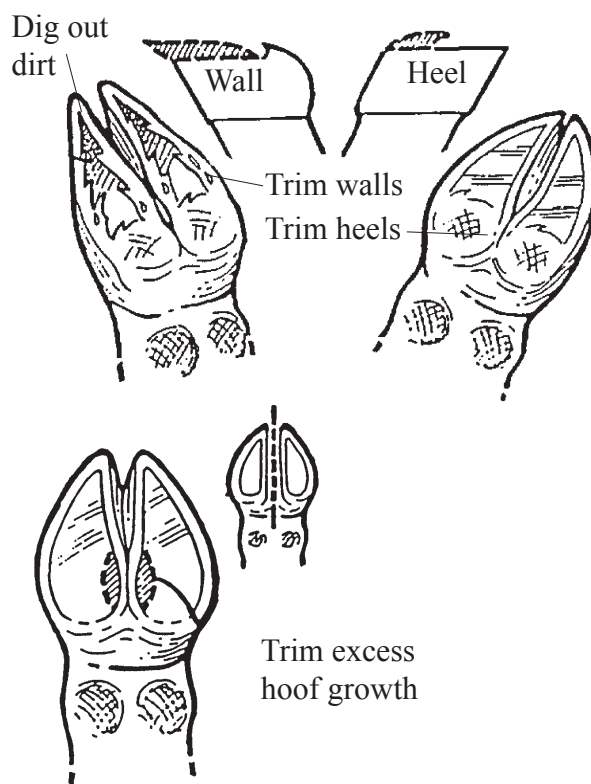

6. Vaccinate Goats to Prevent Diseases

The threat of some diseases can be partly eliminated by vaccinating the goat. For example: Tetanus is caused by a toxic organism that lives in the earth. It can easily enter a goat's body through a cut or puncture wound. A vaccinated goat stands a much better chance of fighting off tetanus. Most goat breeders use "clostridial vaccines" to help prevent tetanus and enterotoxemia (two diseases that goats can sometimes get).

How To Do It

Talk to your veterinarian about recommended vaccinations. If you have only a few goats, you might have your veterinarian vaccinate them. If you have several goats, you might want to learn how to give vaccinations yourself. Refer to the section on how to give an injection.

7. Prevent Exposure to Disease

Many diseases of animals are spread by contact with other animals. For Example: Orf, a contagious skin disease, is very easily transmitted from one goat to another.

How To Do It

- Learn to recognise the most common diseases of goats. Learn how these diseases are spread and how to prevent their spread.
- Try to purchase goats from a farm, which has few health problems.
- Isolate all new goats from the rest of the herd for at least two weeks. Watch them carefully for any signs of disease. Do not put them into your herd until you are quite sure that they are healthy.
- When treating sick goats, keep them separate from the rest of the herd. At chore time, handle the sick goats last. Milk any goats with mastitis last.

8. Prevent Stress

Be sure that stress levels are kept to a minimum. Many diseases stay dormant (inactive), but become active when goats are under abnormal stress.

How To Do It

- Don't overcrowd goats in stalls.
- Isolate a very aggressive goat from the rest of the herd so that it can't cause trouble and injury.
- Keep insects (flies & mosquitoes) away from the goats.
- Goats like a constant routine- try to do the chores at the same time and in the same way.

GOAT HEALTH SIGNS

As much as we try to prevent diseases, it is still possible for goats to become ill. So it is important to learn goat health signs and how to recognise the common diseases that affect goats.

Observation

The best way to detect disease is by spending a little time watching your goats each day.

Here are some of the things that you might watch for.

Healthy Signs

Respiration 15-30 breathes per minute

Pulse Rate 60-80 beats per minute

Behaviour normal

Bright looking and alert

Nose and mouth clean

Ears normal

Coat healthy, sheen

Coat smooth

Skin supple

Suitably covered with flesh

Feces normal pellets

Appetite good

Udder even and soft

Clean legs

Well-shaped feet and hooves

Sick Signs

Out of range

Out of range

Behaviour changed

dull or distressed

Dribbling or nasal discharge

Normally pricked ears drooping

Coat dull, hair falling out

Signs of skin irritation

Skin tight

Too fat or too thin

Feces lumpy, runny, mucus-covered

Off feed

Udder hard, lumpy, milk abnormal

Swollen/hot joints

Misshapen feet, signs of rot

How to Recognize a Sick Goat

Sick Goats are easy to recognize once you know what signs to look for.

Look at the way the goat is standing. A sick goat will stand away from the other goats (usually alone in a corner). It will stand with its feet bunched underneath it and its head down. Note: A healthy young goat kid will usually stretch when it stands up after resting.

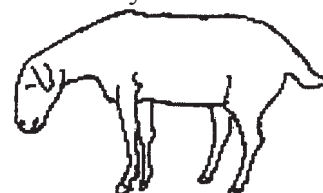

A sick goat's head often looks furry, as if its hair is standing on end.

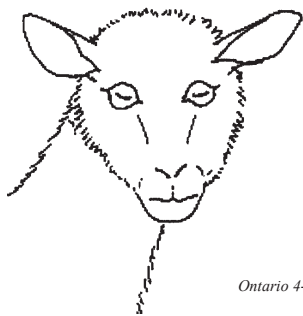

Ontario 4-H Council

A sick goat's eyes are almost always very different looking than the other goats around it. Even in a dim stall the pupils of the eyes will look like slits instead of being big and almost round the way a healthy goat's eyes are when in the dark.

The temperature is taken rectally. A sick goat will usually have a temperature above normal. A normal temperature for a goat is 38.5 – 39°C. A sick goat is usually over 39.5°C and can be as high as 40.5°C. A very sick goat will have a temperature below 38.5°C as it is starting to go into shock and lose body heat. Goats can have different normal body temperatures. It is a good idea to take the temperature of your goat when it is well and write this down so that you know what its normal

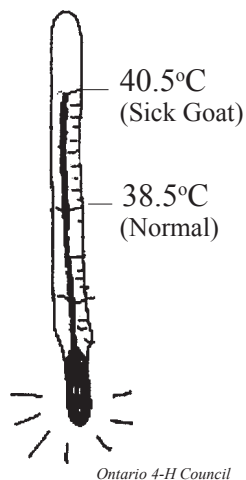

Ontario 4-H Council

A sick goat will often have stopped ruminating. If you watch a healthy goat, you will see that the rumen is active at all times. The muscles of the rumen contract regularly and the goat brings cud back to its mouth periodically to rechew. A sick goat may not have any rumen activity and may not be chewing cud at all.

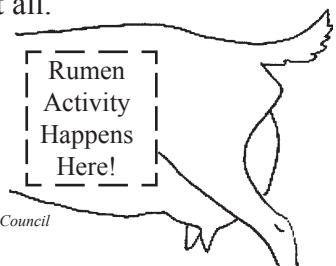

Ontario 4-H Council

Look at the goat's respiration rate. Normal respiration (breathing) rate for a goat is around 25 respiration per minute. You can see the respiration by watching the chest wall just back of the front leg, over the ribs.

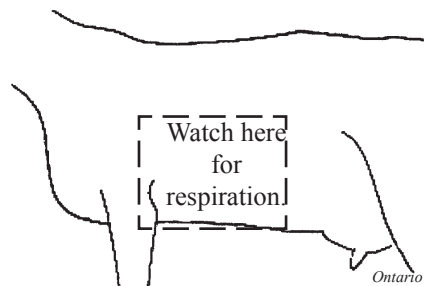

Ontario 4-H Council

Normal pulse rate is 70 to 80 beats per minute. The pulse is taken on the inner side of the thigh. It can also be taken where the head joins the neck below the ear under the jawbone.

Normal Goat Vital Statistics:

- Pulse: 60 to 80 beats per minute
- Respiratory Rate: 15 to 30 per minute
- Rumination: 1 to 1.5 per minute
- Rectal Temperature: 38.6 – 40°C (adult goats)
- Life span, average 8 to 10 years
- Life span, maximum: 30 years

Dealing With Emergencies

Severe Cut on Leg. First stop or control the bleeding. Apply moderate pressure with a bandage or towel soaked in ice water. Seek veterinary assistance. Keep the goat warm and quiet until help arrives.

Other Emergencies. If you find an animal in distress calmly survey its vital signs and general condition so you can fully inform your veterinarian.

- Rate of breathing?
- Signs of bloat?
- Limbs rigid or outstretched?
- Mucous around the nose, mouth or eyes?
- Any bloody discharge from the mouth, nose, vagina or rectum?
- Fever?
- Animal in shock with pale gums?
- Dehydrated?
- Breath smells like acetone?

TESTING

Fecal samples: Used to check for levels of internal parasites such as coccidia or worms. Sometimes used to diagnose illness.

Blood samples: Used to detect many types of diseases.

Milk samples: Used to detect mastitis and to identify the type of mastitis infection in the udder. Sometimes used for pregnancy testing.

Urine samples: Used to detect pregnancy toxemia (ketosis) in pregnant does.

Temperature: Normal temperature can range between 38°C – 40°C (101°F - 104°F). A low temperature or one of 39.4°C (103°F) or more may be a sign of illness.

COMMON DISEASES OF GOATS

The following is just some of the disease and ailments of goats.

Coccidiosis (COCK-SID-EE-OH-SIS)

Cause: Ingestion of infected feces containing tiny intestinal parasites (protozoans) called coccidia.

Symptoms: - Kids can look and feel fine while the damage is being done.

- Stunted growth, usually in kids less than 7 months old
- Occasionally diarrhea
- Dull, dry coat
- Reduced weight gains
- Adult goats are carriers
- A veterinarian can check a stool sample for coccidia
- Sudden death

Treatment: - Sulpha drugs or Amprolium

- Treat young kids for one week beginning at about three or four weeks of age.

Prevention: - Prevent fecal contamination of feed and water

- Sanitary, clean, dry conditions
- Wean gradually over a week
- Avoid overfeeding of milk
- Feed a coccidiostat to aid in prevention

Economic Loss: - Stunted growth with reduced weight gain

- Can weaken kids and make them very susceptible to pneumonia
- Some kids die

Pneumonia (NEW-MOAN-YAH)

Cause: - Usually caused by bacteria

- Stress from poor ventilation, overcrowding

Symptoms: - Depression, general weakness and dullness

- Fever, loss of appetite, drooping ears
- A dry, hot nose
- Rapid difficult breathing
- Coughing and gasping

Treatment: - Antibiotics

- Keep separate from herd
- Encourage eating and drinking

Prevention: - Control coccidiosis

- Good ventilation without drafts
- Reduce dust
- Adequate space

Economic Loss: - Reduced milk production

- Lower weight gains

Scours (SCOW-ERS)

Cause: - Kids not fed colostrum soon enough after birth

- Dirty environment
- May be caused by bacteria, viruses or protozoa
- By overfeeding

Symptoms: - First signs are watery feces, loss of appetite, a temperature and roughness of hair coat

- Later symptoms are loss of weight and dehydration (drying) of body tissues.
- Off coloured or yellowish white feces sign of infectious scours

Treatment: - Cut amount of milk in half and perhaps one or more feedings should be skipped

- Fed electrolytes to replace lost body fluids
- Oral antibiotics may be necessary
- Isolate infected kids

Prevention: - Feeding colostrum within an hour after birth

- Sanitary kid and kidding pens
- Disinfect navel in tincture of iodine right after birth
- Keep hands out of kid's mouths at birth
- Avoid overfeeding milk

Economic Loss: - Reduces the rate of growth

- Makes a kid more susceptible to other infections
- Infectious scours usually results in death in one to three days.

Sore Mouth (Orf)

Cause: - Contact with virus or scabs

- The virus that causes this disease will remain on the premises for a long time.

Symptoms: - Small pimples which turn to scabs or blisters at the corner of the mouth, lips or on the gums.

- Care should be taken since this virus also affects humans

Treatment: Few medicines help

- Iodine can be rubbed into the lesions after the scabs have been removed, thus drying the area and reducing the infection.
- Sanitary precautions to prevent further infection
- Animals usually recover quickly and then are resistant to infection.

Prevention: - Difficult to prevent unless you keep a closed herd

Economic Loss: - Weight loss

- mastitis

Internal Parasites

Cause: - Ingesting worm egg or larva

Symptoms: - Listless, loses weight, poor appetite, diarrhea, a chronic cough, milk off flavour.

- Lower feed efficiency

Treatment: - Dewormers

- some internal parasites build a resistance therefore might want to alter use of drugs

Prevention: - Dewormers

- Check regularly for parasites
- Do not allow animals to eat hay off the ground

Economic Loss: - reduces gain and feed efficiency

External Parasites

Cause: - contact with lice or mites

- flies

Symptoms: - flaky skin and/or hair loss

- Scratching
- Not always visible signs

Treatment: - Insecticides

Prevention: - insecticides

- avoid contact with infected goats
- good sanitation practices

Economic Losses: - lower weight gains

- reduced milk yields

Pinkeye

Cause: - Dust, high winds, bright sunlight

- Infective organism is mycoplasma

Symptoms: - Tears, water streaks below eyes, squinting

- Some can be carriers but not show signs

Treatment: - Antibiotics

- Keep in shade and away from dust

Prevention: - Don't expose goats to eye irritating things

- keep away from infected goats

Economic Losses: - Decreased feed intake

- Possible blindness

Caseous Lymphadenitis (Abscesses)

Cause: - Bacteria

- Contaminated housing
- Stresses can increase the incidence of abscesses

Symptoms: - swelling, especially under ear and on shoulder

Treatment: - Isolate infected goats

- when a soft spot or head appears, cleanse the area with disinfectant and then puncture with a sharp sterilised knife
- Disinfect area
- Use antibiotics

Prevention: - Cleanliness

- Reduce stress
- Vaccines to prevent some abscesses
- Do not buy or keep carrier animals

Economic Losses

- recommended to cull infected animals
- May predispose infected goats to other diseases

Abortion (A-BOR-SHUN)

Cause: - Infection

- Stress
- Nutritional

Symptoms: - termination of pregnancy before fetus can live on its own

Treatment: - Antibiotics

- vaccines in some cases

Prevention: - For infectious cases, remove placenta, fetus and discharges so other goats cannot contract the disease

*Note: If more than one abortion in a short period of time, it is recommended that a fetus be sent to a lab for diagnosis.

Economic Losses: - Reduced number of herd replacements

- Decrease in milk production
- Decreased stock sales

Rabies

Cause: - infectious disease spread by bite or scratch of an infected animal

Symptoms: - Abnormal and aggressive behaviour or dopey, sleepy behaviour

- Goat acts as though it is choking and having difficulty breathing
- Excessive salivation

Treatment: - none if infected

Prevention: - keep goats indoors at times when a rabies outbreak is occurring in your area

- Vaccinate for rabies if recommended by your veterinarian

Economic Loss: - bitten goats may have to be destroyed

- herd will be quarantined for a period of time

Mastitis

Cause: - disease organisms cause infection in mammary system

- Unclean milking practices

Symptoms: - Udders are swollen, hot and painful

- Milk will change colour and can contain flakes

Treatment: - antibiotic udder infusions

- Sometimes injections to severely affected goats

Prevention: - use good sanitation practices at milking

- Keep goat in a clean, dry environment
- Treat dry goats at end of lactation with a dry-cow mastitis infusion to udder

Economic Loss: - Decrease in milk production

- Cost of treatment
- Discarded milk

Ketosis (Pregnancy Toxemia) {have a second section on this, cut and add the abscess information}

Cause: - occurs late in pregnancy often with does carrying two or more kids

- higher incidence with fat does
- Extra demand for energy and inability of the doe to eat enough of her normal diet when the kids are taking so much room
- Doe rapidly metabolised fat from her body stores producing ketones.

Symptoms: - Doe may be depressed, weak, uninterested in food

- Have poor muscle control and balance
- Positive test for ketone bodies in the urine
- If untreated, death occurs within a few days

Treatment: - Consult a veterinarian

- Give propylene glycol twice a day until doe is back to normal.

Prevention: - Proper feeding of does in early pregnancy to avoid over fattening

- Add grain to diet in late pregnancy

Economic Loss: - Death

- Reduced milk production

Enterotoxemia or Overeating Disease

Cause: - Clostridial organism that normally is present in the intestines

- Overfeeding or an abrupt change of feed cause the clostridial organism to grow rapidly and produce a toxin

Symptoms: - Death can occur in a few hours

Treatment: - No Treatment

Prevention: - Vaccinations

Economic Loss: - Death

Caprine Arthritis Encephalitis (CAE)

(KAY-PRINE AR-THR-EYE-TIS EN-SEF-A-LIGHT-TIS)

Cause: - virus present in milk and colostrum of infected does

Symptoms: - Kids – paralysis

- Adults – swollen joints, paralysis, breathing difficulty, hard udders
- Many does carry CAE but do not show it

Treatment: - culling

Prevention: - Feed kids pasteurised milk and heat treated goat or cows colostrum

- When purchasing new goats, make sure that they are CAE free
- It is recommended that does are tested for CAE before breeding.

Economic Loss – Animals culled or die early in life

- lower milk production

White Muscle Disease

Cause: - a shortage of Vitamin E and selenium.

Symptoms: - Kids are born weak or dead or healthy kids suddenly become weak and listless and die.

- Digestive problems in young kids.
- Respiratory problems in young kids.

Prevention: - Give vitamin E - selenium injections to mother goats at 3 to 4 weeks before kidding due date.

- Newborn kids should also receive an injection of vitamin E - selenium when they are 1 or 2 days old.
- See package directions for dosage or consult

your veterinarian.

Rickets

Symptoms: - Affects young, quickly growing kids.

- Leg bones and joints become bent out of shape.
- Ends of the ribs will feel knobby.

Prevention: - Adequate levels of Calcium, Vitamins A and D in the ration will prevent this problem.

Founder

Symptoms: - Feet and lower legs of older kids or pregnant yearlings become very hot and swollen.

- Front pasterns may bend inwards and the rear pasterns bend outwards.
- Onset is very rapid.
- The goat may seem normal at evening feeding and have trouble walking by morning.
- Caused by overfeeding grain or energy rich feeds.

Prevention: - Feed grass-legume mixed hays (first cut).

- Increases in amount of grain fed should be done gradually over time.
- Keep grain storage area secure from goat access.

Ketosis

Symptoms: - Goats in the last weeks of gestation (pregnancy) become weak, lose their appetite, stagger, can't get up.

- Caused by incorrect feeding.
- Usually occurs when a goat is overfed and overweight and cannot consume enough food to meet its nutritional needs.
- Also occurs when a goat is carrying multiple kids (triplets, quadruplets, etc.) but isn't being fed enough food.

Prevention: - Ensure that goats do not get overweight during early pregnancy.

- Feed a high-fibre diet during the first few months of gestation and gradually increase grain ration during the last few weeks.

Milk Fever

Symptoms: - Goats become very weak shortly after freshening.

- Usually lose strength in the hindquarters and fall down with hind legs stretched out behind them.

- There is no fever (even though the illness is called milk fever).

Prevention: - Caused by a shortage of readily available calcium.

- Feeding calcium-rich feeds during late pregnancy can upset the metabolism of the goat so that it cannot draw enough calcium from its body when required to start milking after freshening.
- A good mixed hay should be fed during pregnancy and a higher calcium hay (like alfalfa) added to the diet gradually after freshening.

Treatment: Contact your veterinarian.

Urinary Calculi (Stones)

Symptoms: - A problem sometimes found in male goats.

- Goat cannot urinate, may have a fever and has no appetite.
- Many possible causes, but mineral imbalances are most commonly the reason.

Prevention: - Feed a good mixed or grass hay.

- Provide clean water at all times.
- A grain ration with too high a percentage of protein is not good for bucks either; 14 to 16% protein is usually adequate.
- Provide a salt free-choice.

Treatment: Contact your veterinarian immediately.

Johne's Disease (Wasting Disease)

Symptoms: - seen in animals 3 to 5 years old

- Infection by bacterium takes place in young animals and must occur before they are 7 or 8 months old.
- Older animals may be susceptible but resistant enough that they do not show symptoms
- infection that produces a thickening of the intestine, there by interfering with the animal's ability to absorb nutrients.
- affected goats slowly lose weigh while temperature and appetite remain normal.
- Diarrhoea may develop during the last few days before death occurs.
- Stress seems to trigger the disease or make it progress faster.

Prevention: - purchasing new or replacement animals from disease-free herds

- isolating young stock from mature animals
- provide good sanitation

Treatment: Diagnosis can be made by blood ample or fecal culture. The disease is fatal and there is no known cure.



*Pat Showalter
Kinder Goat Association*

Stocking a Medicine Chest

A small cupboard hung on the inside wall of the barn makes an ideal medicine cabinet to store a few instruments, emergency medication, routine medication and first aid supplies. A goat medicine cabinet will help to handle a lot of first aid needs for your goats but if you have any questions about goat care, call your veterinarian. Check the web page of a goat supply company to see what is available and ask your veterinarian about items that you should stock. Some medications require refrigeration and should be stored in a safe location.

Vitamin Injections

Many goat owners give vitamin injections to goats to help prevent health problems.

Most commercial grain rations have added amounts of Vitamins A, D and E. These levels are generally sufficient to provide what the goat needs. Ensuring the ration you feed is nutritionally balanced will avoid many health problems. Consult with your veterinarian to determine if additional vitamins are required through injection.

Goat Vitamin Injections	
Young Kids Vitamin E & Selenium Vitamin A & D	Purpose - at birth to prevent white muscle disease - at birth to prevent rickets
Breeding Age Bucks & Does Vitamin A & D	Purpose - as a boost in conditioning before breeding season
Pregnant Does Vitamin E & Selenium Vitamin A & D	Purpose - one month before kidding to help prevent white muscle disease in the new-born kids - one month before kidding. For stronger kids. To keep the doe in good condition as she begins to milk.

HOW TO GIVE AN INJECTION

It is sometimes necessary to give injections to goats. Giving an injection means using a needle to place a vaccine or other medication directly into the goat's body. There are several types of injections used when treating animals. Never attempt to give an injection unless you know exactly how to do it.

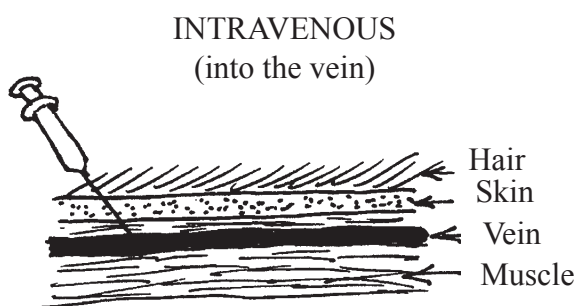
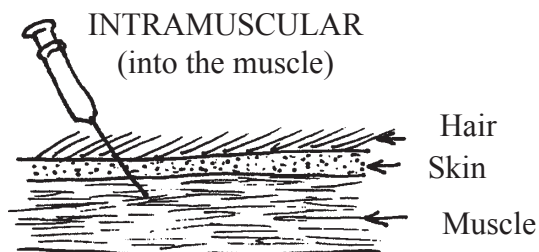
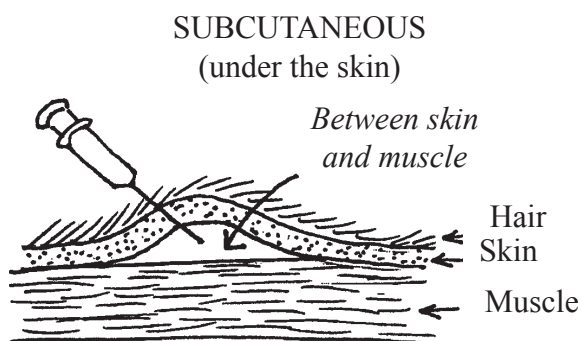
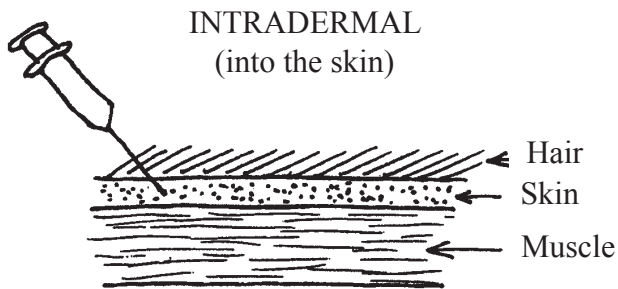

Ontario 4-H Council

Subcutaneous and intramuscular injections are the most useful to the goat owner. Here are some tips on how these injections are given.

Before giving an injections:

Examine the bottle of medication that you wish to use.

- Check the withdrawal period (the length of time between the administration of the drug and the date when the milk and/or meat can be used for human consumption from the treated animal). Follow these instructions closely.

Be sure that it is the correct medication!

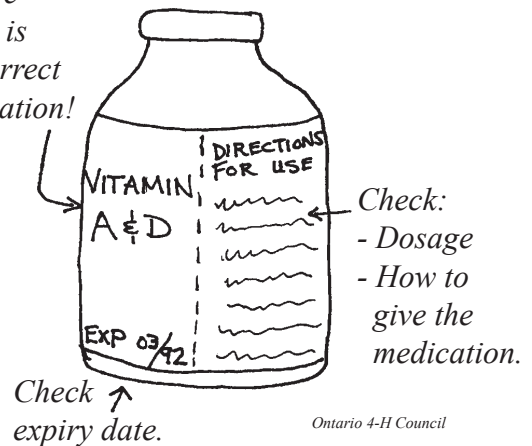

Giving the injection:

To give an injection, you must have a sterile needle and a syringe. These should be an appropriate size for the job. Use a small syringe for small amounts and a large syringe for large amounts. Often, with large dosages, it is recommended to split the injection and inject 2 of the dosage in two locations on the animal.

A small needle, such as a 20 gauge, is small enough to cause very little discomfort for the goat, but large enough to inject most medications no matter how thick they are. The length of the needle is important too. Most goat farmers' find that a 1" needle is long enough for most injections. (Needles are not measured in metric.)

All needles and syringes should be disposable. Disposable needles are sterile, they have a tight

seal so will not leak air, and they are very sharp. The older style reusable needles can carry bacteria and they become dull after a few uses. Use disposable needles and always use a new needle.

BESURE TO DISPOSE OF ALL USED NEEDLES AND SYRINGES VERY CAREFULLY!

Filling the Syringe

The top of a new bottle of medication has a thin metal tab that must be peeled off to reveal the rubber area where medication is extracted using a needle. Clean the rubber area with an alcohol swab before extracting medication.

Leaving the needle inside its protective cap attach the needle to the syringe. Do not touch the tip of the syringe or the plastic base of the needle while you are putting them together. Most needles twist into place.

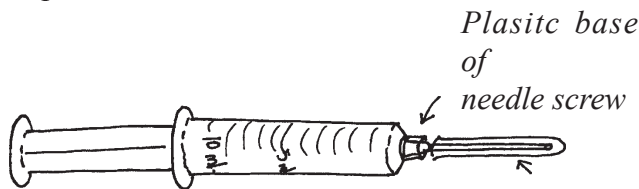

Ontario 4-H Council

Leave plastic cap on needle while you attach needle to syringe. Remove cap to fill syringe. Replace cap until just before you give

Invert bottle of medication gently to mix it. Do not shake because this causes air bubbles in the medication.

Following the diagram withdraw a little extra medication into the syringe and then inject this back into the bottle while you adjust the dosage until it is correct. Do not remove the needle from the bottle and then push it back in. This may introduce bacteria into the bottle.

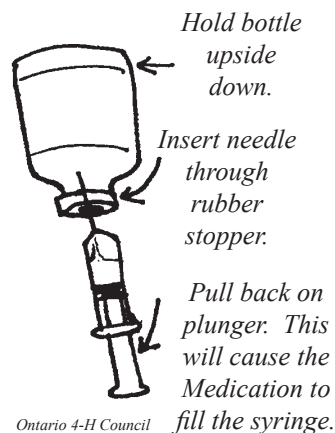

Ontario 4-H Council

To make it easier to withdraw medication from a bottle, pull back syringe to fill with air before pushing needle into the bottle. Allow the air to enter the bottle and then pull out on syringe to fill it with medication. This is necessary because the withdrawal of medication causes a vacuum in the bottle, which may prevent medication from being withdrawn unless air is allowed to enter the bottle.

Look for air bubbles. Hold the syringe with the needle pointed straight up. If there are large bubbles or many small bubbles in the medication, use your finger and gently tap the side of the syringe. The bubbles will float up to the top of the syringe to the place where the needle is attached. Gently push in the syringe to release the bubbles along with a drop or two of the medication. When the medication is bubble-free, give the injection.

Be sure the goat is properly restrained. If the goat moves around, it may cause you to puncture yourself or the goat – or cause the needle to break off or bend.

SUBCUTANEOUS INJECTIONS

Find an area of the goat where the skin is loose enough to pull away from the flesh or muscle. Pull a good pinch of skin out from the goat's body and insert the needle into the side of pinch of skin. Gently swivel the tip of the needle from side to side once or twice to be sure that it isn't actually into the muscle or the skin. When you are sure that the needle is in an empty pocket between the skin and the flesh, inject the medication smoothly and slowly. Withdraw the needle and gently massage the injection site with the palm of your hand to help distribute the medication over a wider area.

Consult an experienced goat breeder for injection locations.

INTRAMUSCULAR INJECTIONS

Find one of the larger muscle masses in the neck area (see diagram below) on the goat away from any bones, nerves or arteries.

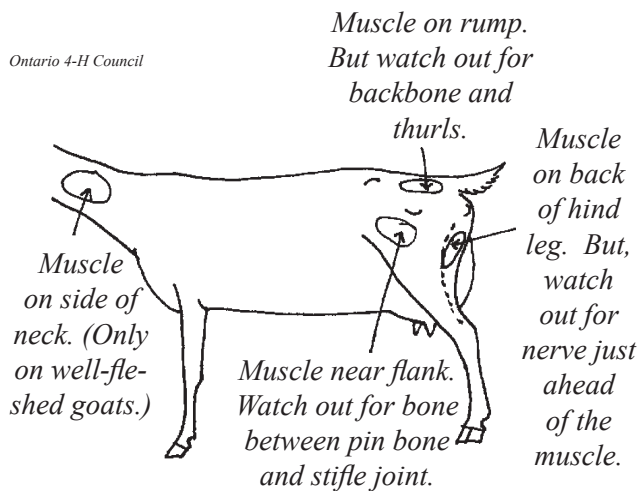

Insert the needle into the muscle and then draw back a little on the syringe plunger. If blood begins to fill the syringe, the injection site is incorrect. Withdraw the needle and try in a different spot.

Watch animals for a few minutes after giving injection. Many farmers keep a bottle of epinephrine with them when they are giving injections. It is an antidote injection that must be given as soon as possible if an allergic reaction is noted. Symptoms of allergic reaction are: sudden weakness, staggering, or falling down; swelling of the eyelids so that they droop shut, any type of nervous reaction such as strong muscle tremors or difficult respiration.

Many medications cause some stinging at the injection site so the goat may scratch at the spot, rub itself against the wall, lie down and get up again a few times, or fuss in some other way. This may be quite normal.

FITTING AND SHOWING YOUR GOAT

You should have a collar on your goat when walking the animal. Collars are best made of plastic link chains and are sold at most livestock supply companies. These collars will break away



if they become snagged on a fence (this will prevent choking in case of an accident). When showing, you may want to have a special collar. This should usually be narrow leather or nylon collar or a smooth chain collar that is snug enough to stay on the goat's neck without slipping over its head. However, it must be loose enough to allow you to comfortably keep your fingers through the collar as dairy goats are never shown on a leash. Pygmy goats are shown with a short leash and collar that matches the colour of the goat so that it is inconspicuous.

Goats are very smart and can learn a large number of tricks and tasks. Your goat should have a name and you should use the name whenever you talk to your goat. In time, your goat will learn to come to you when it hears you calling its name.

In the show ring, goats are led without a lead by holding the collar in one hand. It will be much easier to teach a goat to lead if you begin while it is still young. You may practice leading your goat by its collar for a few minutes each day. You can also make training your goat into a game if you play with it regularly and encourage it to run after you when you call its name. Run for a short distance and then wait for the kid to catch up. Be patient and gentle.

An animal that will lead properly has a decided advantage over one that will not lead. It is especially important in the show ring and equally valuable when showing to a buyer or to someone who is "just looking".

The following is an idea to help you train your goat to lead. This idea is the same as used in breaking foals to lead. A piece of sash cord or other small diameter rope is used. Make a

stationary loop at one end. This loop should be large enough so that the knot should come about to the shoulders; the loop to go over the animal's quarters above the hock and lay on the side from which the leading is done. The free end should run through the collar or halter. Then attach regular lead. Start leading in a circle using regular lead. If the animal hangs back or sulks, a couple of jerky pulls on the rump lead rope generally starts it. Keep rump lead rope slack when the animal leads freely. After a few turns around, reverse your direction. Teach your animal to lead from either side. This procedure may be used on mature animals, does, or bucks, yearlings or kids. A few minutes a day for about a week should be sufficient. Some animals will lead nicely with a lead rope attached to the collar, but will balk when being led by the collar alone without the lead attached. This lead works well in such cases. Just remember to do all leading with regular lead or hand on the collar. Use pressure on the rump lead rope only when necessary.

Very soon the goat will walk or run beside you wherever you go. This is valuable training if you wish to bring your animal to shows, or if you plan to take your goat on long walks. Your goat can also be trained to carry a small packsack like those made for large dogs. In some parts of the world, goats are used as pack animals, especially in mountainous areas. Some people also train goats to pull small carts (this is a good activity for a large castrated male goat).

CLIPPING A GOAT

Clipping a goat is not only something that is done for the show ring. Many breeders clip their goats in the spring to get rid of long hair that could be hiding external parasites on the goat's skin. Short hair is also much cleaner and will not hold dirt or bits of hay that could fall into the milk pail during milking.

Tools and Equipment

- A set of electric livestock clippers (with clipping blades and not sheep shearing blades).
- Light machine oil to oil the blades
- Extensions cord (if necessary).

How to Clip

Tie the goat up in a way that will prevent it from moving around. This can be done by clipping the goat's collar to a tie-up ring placed on the wall about ½ metre above floor level. Some people prefer to clip goats while they are on a milking stand. The milking stand should be very steady and secure so that it won't tip over if the goat misbehaves.

Get your clippers ready and adjusted properly. Be sure that the blades are clean and sharp. Most clippers have an adjusting screw that holds the blades in place. This should be turned until it begins to tighten and then turned back about a quarter of a turn. If it is too tight, it will make the blades press too hard together and wear them out and strain the electric motor.

Squirt a generous amount of oil onto the clipper blades before you turn them on. Also, drip oil into the little holes marked "OIL" that should be located on the clipper head near the blades. Check to make sure that there are no pieces of hair clogging the little screen that is located near the back of the blades. This screen allows air to go into the clippers to cool the motor. If pieces of hair clog up this screen, the motor will overheat and burn out. Make sure to check the screen every few minutes while you clip. It gets clogged very quickly.

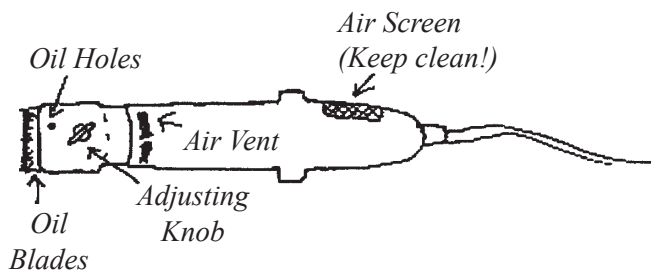

When everything is ready, turn the clippers on. Let them run for a few seconds so that the goat gets used to the noise.

Always clip from rear of the goat toward the head and neck. Clip up toward the tail and pin bone. Clip against the hair. Use smooth even strokes with the clippers. Try not to pinch or nip the goat while clipping. Do one side at a time. Use care when clipping around the milk veins on stomach and around or near eyes.

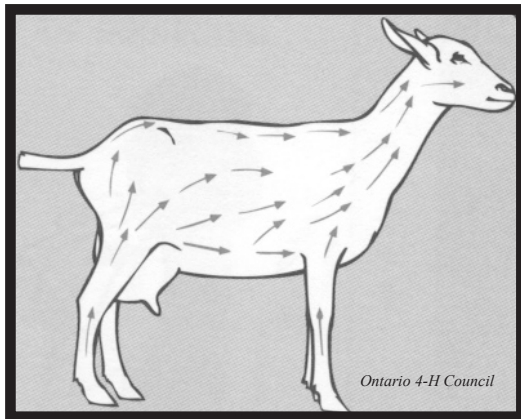

You should clip against the direction of the hair growth. Hold the clippers almost parallel to the skin. Don't "dig in" towards the skin with the blades. The clippers work best when the bottom blade is resting against the skin as it cuts. Use long, continuous strokes as you clip. This will give a better "finish" to your clipping job. Short strokes will give a patchy look to the hair – especially on a black-coloured goat.

1. Start on rear leg, at the hocks or below. Clip up toward the tail and pin bone. Clip the underside of the leg as well as outside.
2. Clip forward over the rump, hipbone and forward along the back.

3. Clip forward and upwards against the hair on the flank and barrel.
4. Clip past the heart girth and over the shoulders.
5. Clip belly and underside of dairy goat.
6. Clip frontleg, starting low as possible, underside as well as outside.
7. Clip between front legs on chest.
8. Clip neck, working up towards throat and jaw. Clip under chin and along jaw if dairy goat will permit.
9. With small clippers, clip udder.
10. With scissors, trim long hairs in ears or press the ear shut flat and then trim the hair that sticks out of the ear with the clippers.
11. Trim tail last, leaving brush-like effect on tip.
12. Brush gently with the hair to smooth coat and remove any loose particles of dry skin for finishing touch.



When you are all finished treat any small nicks with a little bit of wound ointment (if you were careful, there should not be any cuts). Also check hooves at this time and trim if necessary.

GETTING READY

WEEKS BEFORE THE SHOW

- Be sure that the goat has been fed well so that it can be in adequate condition.
- Trim the hooves on a consistent basis so you only have to trim and smooth with a rasp the day before the show. The bottom should be parallel with the hairlines.
- Brush the goat regularly to remove loose hair and dandruff.
- Work with the goat and handle it a lot so that it will behave well in the ring. Have other people come up and examine it while it is being held so that it learns to be touched by other people.

- Fill out your entry list carefully and accurately, and send it to the proper place on the date as specified.
- Clip the goat if the weather is not too cold. The whole body should be clipped except for the tip of the tail. If you have not clipped a goat before, be sure to have an experienced older 4-H member help you. The length of time prior to the show will depend on the colour of the goat. For example, black or white coloured goats should be clipped 1 week to 10 days before the show.

A FEW DAYS BEFORE THE SHOW

- If the weather is nice, bathe with livestock shampoo and warm water. Rinse with a mixture of one tablespoon of laundry bluing to four litres of water to make white areas glisten and coloured areas shine. Be sure that the goat is dry before returning it to a cool barn.
- Make sure that you have a well-fitting collar for the goat. It should be a narrow leather collar, a chain collar or a plastic collar. A narrow collar or chain is better as it is not very noticeable and helps to show off the goat's long graceful neck. Be sure that the collar fits properly, - not so loose that it slips off over the head and not so tight that you can't hold it comfortably. Be sure that the collar won't break when showing.



The collar should not be too tight because your fingers will be under it as you lead your goat in the show ring.



A wide collar looks clumsy.

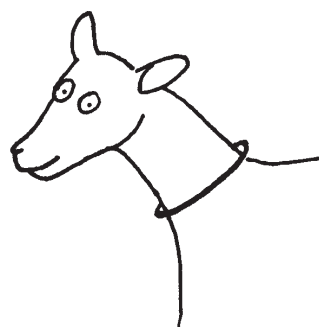

A narrow collar looks more stylish.

- Make sure that you have clean, white clothes to wear in the showing.
- Make a checklist of all the things needed on show day.
- Trim the feet properly.
- Prepare an attractive sign to display at your stall area identifying the breed, and the name of you and your goat.

THE DAY BEFORE THE SHOW

- Pack up everything you will need for the show the next day.
- Each exhibitor should provide all the necessary feed and equipment needed for his stock.
- Water and feed all of your animals in your private pails and boxes only.
- Always plan to handle and exhibit your animals with gentleness, dignity, and pride, whether they are in or out of the show ring.
- If you are travelling to the show a day before, go over your checklist before you leave home. Remember your grooming equipment and your clean clothes.
- Make every effort to keep your stalls and aisles clean, neat and attractive at all times.
- Provide proper tattoos, identification, and registration certificates for each animal.
- Inform yourself fully with the rules of the show and endeavour to follow them completely.
- When you get to the show, check in with the person in charge. Ask when and if a health inspection will take place. Get the goat unloaded and make sure that it is comfortable and has food to eat.
- Give the show officials your undivided attention and co-operate with them to the very best of your ability.

Angora Goat Fitting Hints:

- ❖ *Cleaning: Never give an Angora a full bath. This will remove the lanolin in the mohair. Just spot-clean the goat's face, ears, feet and legs with a damp cloth.*



Clipart by Jackie Nix

- ❖ *Hooves: Trim and polish the hooves. Sand the horns and polish with light oil.*
- ❖ *Clipping: Trim any urine-stained hair on the rear of the goat about two months after shearing. Make sure the fleece is free of chaff and straw. Don't do anything to disturb the natural qualities of the fleece.*

THE DAY OF THE SHOW

- On show day your best efforts and considerations will help to make it a better show.
- Feed the goat first thing in the morning.
- Groom the goat. Be sure to wash the nostrils and insides of the ears with a damp cloth. Don't forget to wash well under the tail. Wash the udder and teats. Use a soft scrub brush and scrub all of the feet well.

BEFORE YOU GO INTO THE SHOWRING

- Brush the goat and scrub its feet again if necessary.
- Get changed into your "whites" (white clothes). You should keep a piece of chalk in your pocket. If you get a dirt smudge on your white clothes, rub some chalk over the spot to make it less noticeable.
- Know the date of birth of the goat and if it is a milker, know the date that it freshened and how many lactations it has had.

The Well-Prepared Team

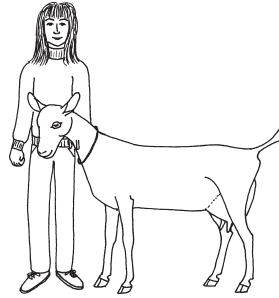

Ontario 4-H Council

- * Goat is freshly clipped.
 - * Goat's feet are trimmed and scrubbed clean.
 - * Goat's ears, nostrils and under tail are washed.
 - * Udder is clean.
 - * No stains on the goat's coat.
 - * Well-fitted narrow collar.
 - * Showperson in clean white
- Pay attention to the order of the show and be sure that you are ready to go in for your class. Don't be late.
 - GOOD LUCK AND HAVE FUN!

Good showmanship is an art. It takes a great deal of work to be really skilful in the showing. With work, you can learn to be excellent at showing.

What Happens When You Go Into The Ring?

When you bring the goat into the ring, the judge will probably ask you to circle and walk in a clockwise direction. You might practice deciding which way is clockwise and counter clockwise so that you don't get confused by these terms when you hear them.

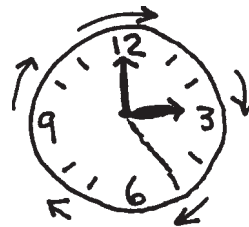

Think of the direction that hands on a clock move.

This is a clockwise circle.

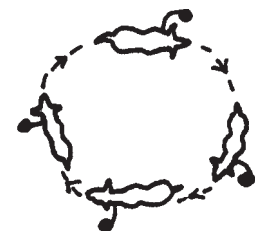

This is a counter-clockwise circle.

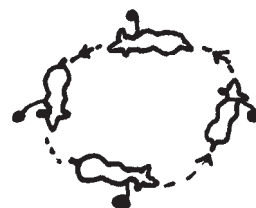

Ontario 4-H Council

The judge will ask the class to stop and line up in certain ways from time to time. A head-to-tail line-up means that the goats are standing in a line one after the other.



Goats facing in same direction in a head-to-tail line-up.

Ontario 4-H Council

A side-by-side line-up has goats standing side by side facing in the same direction. The judge will always indicate which way he or she wants the goats to be facing.



Side-by-side line-up all goats facing the same way.

Ontario 4-H Council

When a judge asks the class to stop, either in line or in a circle, quickly set your goat up into a show stance that will best show its good points. If there are any low spots in your area of the ring, move to an area where the ground is more even OR position the goat so that its front feet are on a rise. Never stand a goat with its front feet lower than its rear feet. A good exhibitor will always find a good spot in the ring to best show off the goat.

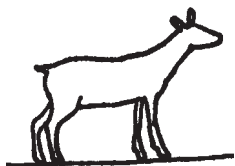

This looks better ...

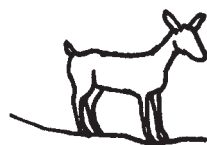

than this!

Ontario 4-H Council

Always keep the goat between yourself and judge. When you must change sides, change hands on the collar and step across in front of your goat. Never try to cross behind – it looks clumsy and the goat could get away from you.

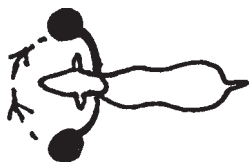

Cross to the other side in front of the goat.



Don't cross behind like this!

Ontario 4-H Council

Lead the goat at a comfortable speed. Don't jerk and pull on the collar. Hold the head up slightly, but don't bend it up into an unnatural position.

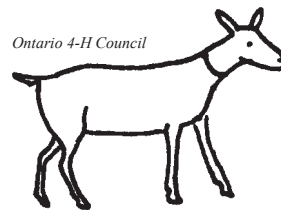

Ontario 4-H Council

This is right!

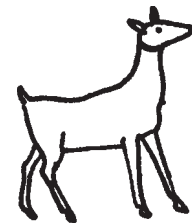

This is wrong!

Pose your animal quickly and neatly when you are asked to stop. Don't fuss with it once it is into position. Don't overstretch the goat into an unnatural show stand. This is a very common mistake made by many exhibitors. When the goat is in position, stand on the opposite side of it away from the judge. You may kneel down if you have control, but don't put your knees on the ground.

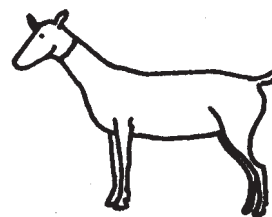

This is right!

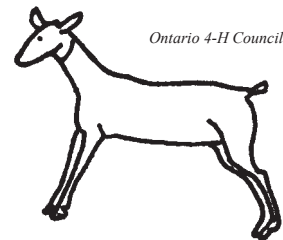

Ontario 4-H Council

This is wrong!

The judge will probably ask exhibitors to exchange animals during the class. The judge will do this to see how well each exhibitor can handle an unfamiliar goat. Do your very best to show any goat given to you. The judge may also ask you what the strengths and/or weaknesses are of the goat you have been asked to show. Be ready by quickly examining the goat as soon as you begin showing it.

Be courteous to other exhibitors. Don't chat with others when in the ring. If you are distracted, you will miss instructions or forget to switch sides as the judge moves about the ring.

Be sure to hold the goat properly when the judge wishes to check the ears, mouth, udder, etc. When the judge is examining the teeth or ears, hold its collar firmly and place your leg across in front of the chest so that it cannot leap forward or up. When the judge is examining the udder or teats, lean across and lift up the front leg on the side opposite

to you. With one leg lifted off the ground, the goat will not be able to leap around.

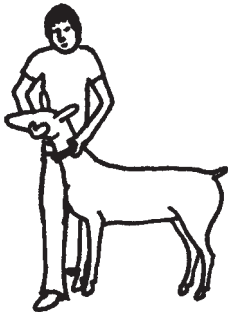

Position used when holding a goat to have ears or teeth examined by the judge.

- Hold head steady with one hand.
- Hold collar with the other hand.
- Place leg across in front of goat.

Ontario 4-H Council

Position used when holding a goat while judge examines udder or back part of goat (i.e. teats of a kid or buck).



- Hold collar with one hand.
- Lean across goat's back and lift front leg on opposite side to the side you are standing on.
- Hold leg up until judge has finished examining goat.

Ontario 4-H Council

When showing a large goat, it is often easier to set up its legs by having the goat step back into a good position. Do this by gently pressing two or three fingers into the spot where the front leg meets its chest. The goat will move that leg back a little. By gently doing this once or twice, you can get the animal to position itself without having to lift and place its feet. This is also a good technique to use if you are asked to show a goat that kicks when you touch its legs while setting it up.



To move a leg back a step, press here on the chest. The goat will usually also move the hind leg on the opposite side a step back. A large goat may be easily set up in this way.

Ontario 4-H Council

Show the goat at its best in the showing at all times and not just while the judge appears to be watching you. When the placings are finally made, keep the goat well posed as the judge gives the reasons for the class. Do not leave the ring until and placings are read or the exhibitors are excused.

Retirement from the ring should take place in the order of the placings in the class.

Whatever the outcome of the class, be sportsmanlike and courteous. Be sure to congratulate the winner. Be prepared to accept the final decision of the judge.

What is the Judge looking for in a Showmanship Class

Here are the main things that a judge watches for during a showmanship class.

- ❖ Exhibitor always paying attention to the judge.
- ❖ Exhibitor always aware of where the judge is in the showing.
- ❖ Exhibitor quickly getting the goat set up into position without fussing around too much.
- ❖ Exhibitor showing the goat in a way that emphasizes the goat's best points while downplaying the weak points.
- ❖ Exhibitor always courteous to other competitors.
- ❖ Exhibitor is knowledgeable and knows all of the parts of the goat if asked.
- ❖ Exhibitor is able to recognize strong and weak points on any goat given to him/her to show.
- ❖ Exhibitor has control at all times.
- ❖ Exhibitor knows the proper manoeuvres when in the showing (a manoeuvre is a special way of moving an animal around the ring – you should learn to do these properly).
- ❖ Exhibitor has properly prepared the goat for the class and the goat is spotlessly clean and well behaved.

Showring Manoeuvres

There are some established manoeuvres, which the judge will ask exhibitors to carry out. To do well in a showmanship class, you must know these.

Walking Two Goats Out of a Line Side-By-Side

The most difficult manoeuvre happens when a judge asks two exhibitors in a side-by-side line-up to walk forward out of the line for a distance and then return to the line. While moving the two goats through this manoeuvre, the exhibitors should be sure to keep the goats fairly close to one another (about one metre apart). This is because the judge wants to compare the two goats while they are walking away from and back towards the line. If they are several feet apart, the judge cannot compare them properly. Both exhibitors should try to keep them moving at about the same speed so that they are side by side throughout the whole manoeuvre. ALSO, do not make too tight a turn at each end of manoeuvre. The judge will want to see a gentle turn that does not put stress on the hind legs as it turns.

The two exhibitors always keep the goats side by side during this manoeuvre. They Do Not walk between the goats at any time. This means that the exhibitor must change to the other side of the goat while circling at each end of the manoeuvre.

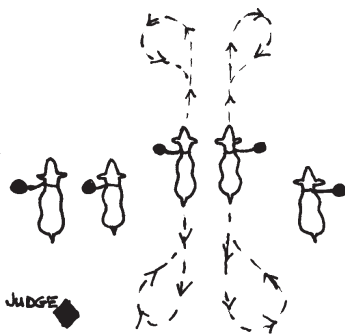

Ontario 4-H Council

Moving Into Another Position In a Side-By-Side Line-Up

Another difficult manoeuvre takes place when the judge asks one exhibitor to move a goat to a new place in a line-up. If the judge is standing ahead of the line, the goat should be led forward out of the line, then led out across in front of the line. The goat should then be led through the line in the space where it has been indicated that it should move to. Once past the line, the exhibitor should make a smooth circle behind the line and come back into the line in the new position.

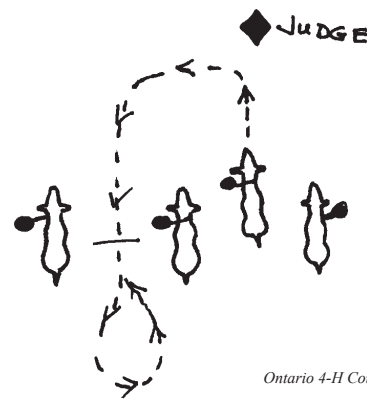

Ontario 4-H Council

** Remember to keep your goat between you and the judge during the entire manoeuvre.*

Another variation of this manoeuvre occurs when the judge is standing behind the line and asks for the same manoeuvre. The exhibitor should lead the goat forward a few steps and then come back through the line, then turn and go across the back of the line until coming to the new position. The exhibitor then turns the goat into the new position and sets it up.

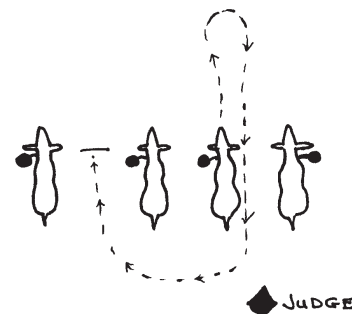

Ontario 4-H Council

Moving To A New Position In a Head-to-Tail Line-Up

The exhibitor is asked to move the goat up or down the line into a new position. When the exhibitor is moving up in the line-up, he/she should lead forward out of the line on the side of the line that the judge is standing on. The goat is then led up the line into the new position and placed in that spot. If the exhibitor is moving a goat down the line towards the end he/she should circle out and back towards the end of the line and come around into the new position.

Going back into another space.

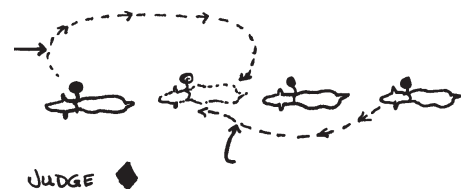

Moving up into a new space in line.

Ontario 4-H Council

A Special Note About These Manoeuvres

When a judge asks an exhibitor to move a goat in a line-up, he or she is watching for something important. The judge not only wants to watch how the exhibitor does the move, but also wants to see if the other exhibitors are courteous and makes room for the goat in the new position. Exhibitors on either side of the new position should ensure that there would be a big enough space for the exhibitor to take the goat into. This may require some careful movement in the line. All movements should be made with a minimum of fussing and noise.

Dairy Goat Showmanship Guidelines

	Perfect Score
Exhibitor’s Appearance	10
<ul style="list-style-type: none"> • Neat and clean. • Appropriately dressed. (A long sleeved white shirt and white pants are preferred.) 	
Goat’s Appearance	40
<ul style="list-style-type: none"> • Normal growth neither too thin or too fat (10) • Hair clean and properly groomed, hooves trimmed and goat neatly disbudded if animal not naturally hornless (10) • Entire body clipped with neatly trimmed tail and ears (10) • Entire body free from stains as possible with special attention to legs, feet, tail area, nose and ears (10) 	
Showing the Goat	50
<ul style="list-style-type: none"> • Lead the goat slowly and gracefully around the ring in a clockwise direction, holding the goat’s head high. The goat should lead readily and respond quickly. • Walk forward on the left side 	

of the goat.

- Hold collar or small linked neck chain with right hand. Line up with plenty of space between your goat and the next one.
- Set up goat with front feet directly under shoulder. Position the end of the goat nearest the judge (head or rear) first.
- Squat or stand next to the goat. Keep the goat between you and the judge at all time. Lead from the side away from the judge. Change placing, by leading the goat forward out of the line-up to the back area, gracefully make a “U” turn toward the line-up and move into the new position.
- Answer the judge’s questions about the goat score card, parts of the animal, information about goats in general and your goat in particular.

TOTAL 100 points

Angora Goat Showmanship Guidelines

	Perfect Score
Exhibitor’s Appearance	10
<ul style="list-style-type: none"> • Neat and clean. • Appropriately dressed. 	
Goat’s Appearance	40
<ul style="list-style-type: none"> • Body clean and properly groomed. • Mohair free of stains. • Body healthy looking and free of external parasites. • Hooves trimmed. 	
Showing the Goat	50
<ul style="list-style-type: none"> • Stand to the left of the goat with your left hand under the 	

animal's jaw and the right hand on the left horn.

- Walk forward at a slow and easy pace with goat's head up.
- Always keep the goat between the judge and you.
- Know where goat and judge are at all times.
- Set goat with feet placed directly under "the four corners" of its body. Do so by lifting each foot from underneath the goat and placing it where you want it.
- Keep goat set and under control while the judge examines it.
- Answer judge's questions about goat score card, parts of the animals, information on goats in general and your goat in particular.

TOTAL 100 points

Pygmy Goat Showmanship Guidelines

Perfect Score

Exhibitor's Appearance 10

- Neatly dressed.
- Clothes don't distract from animal

Goat's Appearance 40

- Condition – Normal growth. Not too fat or too thin. Free from illness (10 points)
- Hair and Hooves – Coat clean and healthy. Trimmed according to breed specifications. Undercoat combed out. Hooves trimmed evenly. (10 points)
- Cleanliness and Trimming – Animal clean and free of any dirt in the coat. Eyes, ears, nose, hooves and tail should be thoroughly cleaned. (20 points)

Showing the Goat 50

- Leading the Goat (10 points)
Lead the animal in a clockwise direction. Always keep goat between you and the judge. Hold the lead so excess doesn't hang down. Walk the goat at a normal pace. Watch the judges for instructions and position.
- Standing and Showing (30 points)
Always keep the goat between you and the judge. Set up the animal in the most advantageous manoeuvre whenever stopped.
- Exhibitor Behaviour (10 points)
Be courteous, responsive and always alert. Smile

TOTAL 100 points

Pack Goat Showmanship Guidelines

Perfect Score

Exhibitor's Appearance 10

- Neat and clean
- Wearing hiking clothes and shoes for weather

Goat's Appearance 25

- Showing normal growth, neither too fat or too thin (10)
- Hair clean and properly groomed (5)
- Hooves trimmed and shaped to enable animal to walk and stand naturally (5)
- Clean body from stains as much as possible, with special attention to the legs, feet, tail area, nose and ears (5)

Showing the Goat 35

- Enter, leading the animal at a normal walk around the ring in a clockwise direction, holding the lead or collar with the right

hand. Goat should lead readily and respond quickly. When judge changes placing, lead animal forward out of line, down or up to the place directed then back through the line, finally making a U-turn to get into position. You shouldn't lead your pack goat using the lead as you would on a trail, but you may hold the collar if necessary for certain manoeuvres. You will be requested to exchange animals and perform manoeuvres to show ability to handle another person's goat. Walk at a normal pace, not allowing the goat to get ahead or out of control. Always walk on the side away from the judge. (15)

- Pose the goat with front and rear feet squarely beneath it. Do not crowd other exhibitors. When the judge is observing the goat, if it moves out of position, replace it as quickly and inconspicuously as possible. (5)
- The goat should be calm and respond quickly to changes in position. Poise, alertness and courteous attitude of the exhibitor are desired at all times in the show ring, until the entire class has been placed. (15)

Questions 15

- The exhibitor will be asked five questions concerning pack goats and hiking.

Pack Goat Trail Test 15

- Appropriately fitted goat pack containing 10% of weight or less for less than 1 year of age, and 10% to 20% weight for goats 1 to 2 years of age. Lead equipment should consist of a working collar or halter. The ten essentials of

hiking will be carried on the person in a fanny pack, back pack or vest. The trail test shall consist of five obstacles.

TOTAL 100 points

Herdsmanship Score Card

Perfect Score

Preparation of the Exhibit 40

- Adequate, clean bright bedding (10)
- Animals attractively spaced in pens (10)
- Decorations neat and attractive (5)
- Appropriate signs (5)
- Well-chosen colour scheme (5)

Appearance and Attitude of Exhibitors 20

- Knowledgeable, courteous, friendly, able to answer questions about exhibit or goats (15)
- Clothes and person neat and clean, appropriately dressed (5)

Care of the Exhibit 40

- Goats clean, clipped (before show), feet trimmed (20)
- Aisles kept neat and clean (10)
- Attractive, organised feeders and feed equipment. Feed and equipment stored neatly when not in use (out of sight if possible), and kept clean (10)

TOTAL 100 points

GOAT JUDGING

The Parts of the Goat

It is important to know the parts of the goat. When you are judging, you will be asked to compare and talk about goats. To do this, you must be able to use the proper names for each part of the goat. The following is a diagram of a goat and its parts.

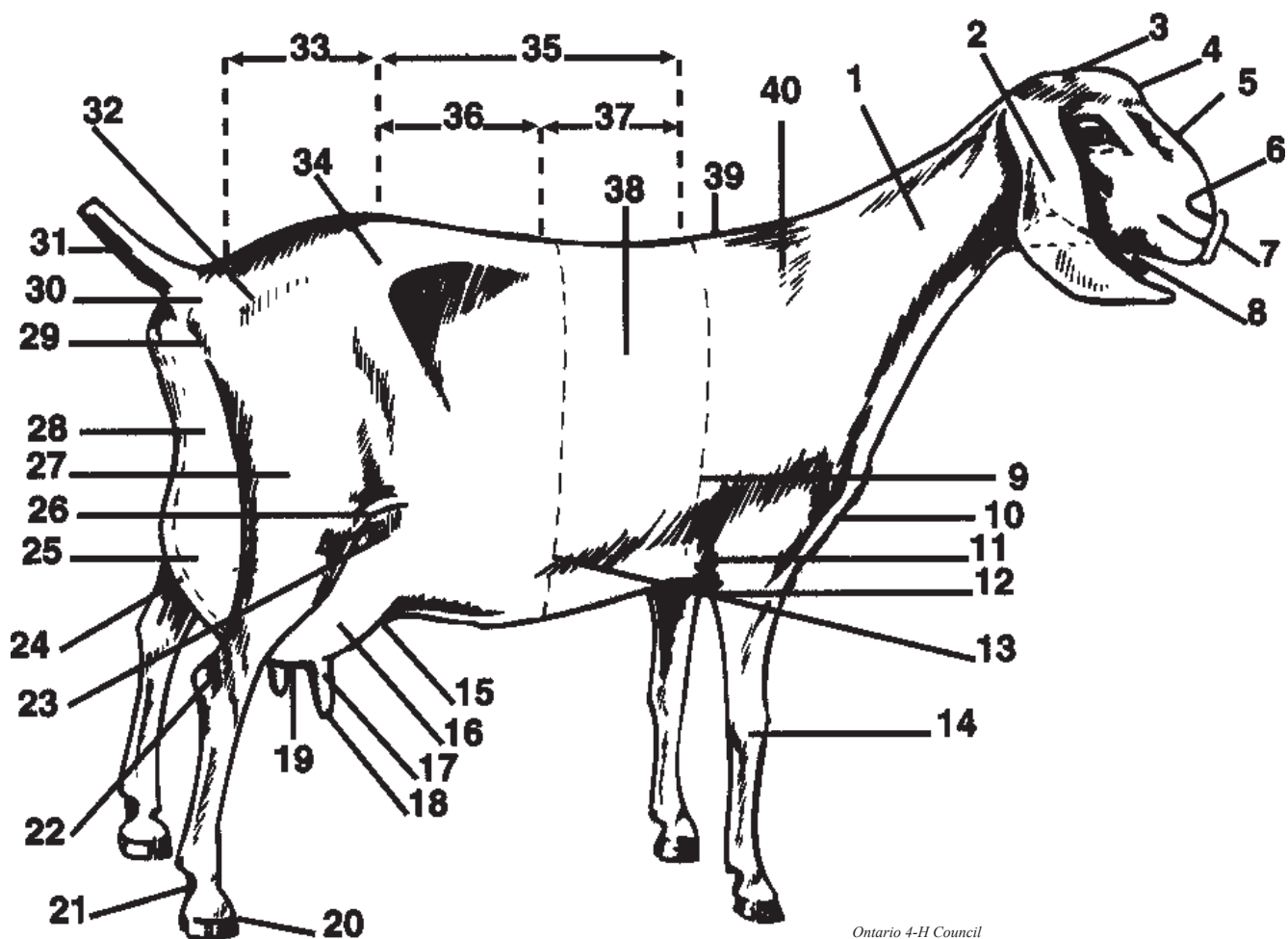

Ontario 4-H Council

Parts of the Goat

- | | | |
|---------------------------|--------------------------------|--------------------|
| 1. neck | 16. fore udder | 30. tail head |
| 2. ear | 17. teat | 31. tail |
| 3. poll | 18. orifice | 32. thurl |
| 4. forehead | 19. floor of udder | 33. rump |
| 5. bridge of nose | 20. hoof | 34. hip |
| 6. nostril | 21. pastern | 35. back |
| 7. muzzle | 22. hock | 36. loin |
| 8. jaw | 23. flank | 37. chine |
| 9. heart girth | 24. medial suspensory ligament | 38. rib |
| 10. brisket | 25. rear udder | 39. withers |
| 11. point of elbow | 26. stifle | 40. shoulder blade |
| 12. chest floor | 27. thigh | |
| 13. barrel | 28. rear udder attachment | |
| 14. knee | 29. pin bone | |
| 15. fore udder attachment | | |

Judging Dairy Goats

When judging dairy goats the judging scorecard is used to help to compare the animals being shown.

CGS Scorecard for Does

GENERAL APPEARANCE TOTAL 35 POINTS

Attractive individuality indicating femininity, vigour and strength with a harmonious blending and correlation of parts; impressive style and attractive carriage; graceful and powerful walk.

Style Graceful appearance; smoothness of blending throughout, especially the shoulder blades which should be set smoothly against the chest wall and withers; full in the crops. **5**

Breed Characteristic & Head Appropriate for the breed. **5**

Back The back strong and appearing straight; chine and loin broad, strong and nearly level. **5**

Rump Long and wide, nearly level from hips to pins and thurl to thurl; hips wide and level with the back; pin bones wide apart, nearly level and well defined; tall head set slightly above and neatly between the pin bones; tall symmetrical with the body. **8**

Feet & Legs Legs wide apart, squarely set; bone flat and flinty; tendons well defined. Pasterns of medium length, strong and with some spring. Feet pointed forward with closed toes, deep heel and level sole. Forelegs straight with clean knees. Hind legs nearly perpendicular from hock to pastern when viewed from the side; high and wide in the escutcheon with legs straight and well apart when viewed from the rear. Hocks clean. **12**

DAIRY CHARACTER TOTAL 15 POINTS

Animation, angularity, general openness and freedom from excess fleshing, giving due regard to the period of lactation.

Neck long and lean. Throat clean. Withers well defined and wedge shaped, rising above the shoulder blades. Ribs wide apart, bone wide, flat and long. Flank deep with arch well defined. Thighs incurving to flat when viewed from the side. Loose, pliable skin with fine hair. **15**

BODY CAPACITY TOTAL 15 POINTS

Relatively large in proportion to the size of the animal, providing ample digestive capacity, strength and vigour and showing desirable length of body.

Width throughout beginning with the head and carried through the chine and loin. Barrel deep and strongly supported, ribs well sprung with depth and width tending to increase towards the flank. Heart deep and wide with well sprung foreribs; chest floor wide; fullness at the point of elbow. **15**

MAMMARY SYSTEM TOTAL 35 POINTS

A strongly attached, well-balanced udder of good quality, indicating ample production and a long period of usefulness.

Medial Suspensory Ligament and Closely Related Ligament strong and well defined, udder floor carried above hocks. (5 pts) **15**
Shape, balance and well rounded. (4pts)

Traits Texture, soft and pliable, free of scar tissue, well collapsed after milking. (4pts)
Teat placement, well apart, squarely set and plumb. (2 pts)

Fore Udder Carried well forward, tightly attached, wide, blending smoothly into the body and indicating capacity. **8**

Rear Udder High, wide and smooth, securely attached in the escutcheon and indicating capacity. **8**

Teats Uniform, of correct length and circumference, cylindrical in shape, well delineated. **4**

TOTAL POINTS 100 POINTS

(from the Canadian Goat Society)

The scorecard is broken down into a few main categories. These are General Appearance, Dairy Character, Body Capacity and Mammary System.

General Appearance

This refers to the general structure and overall appearance of a goat. It includes the bone structure of the goat's entire body, the proportion of its parts in relation to one another, and it also includes the breed character and colour of the animal.

On the milking doe scorecard, general appearance is given 35 points out of a total of 100. On the

buck scorecard, it is given 55 points. On the kid scorecard (junior doe), it is given 35 points out of a total of 65 points.

Here are some of the parts that make up General Appearance.

Breed Character and Colour

Goats should have the correct colour of hair and markings for their breed. The ears must be the correct shape and carriage (usually either erect (point-up) or pendulous (floppy)) for the breed.

Alpine & Saanen



erect ears
straight nose

Nubian



roman nose
pendulous ears

LaMancha



very tiny ears
straight nose

Toggenburg



erect ears
slightly dished nose

A dished face has a slight curve between the forehead and the nose.



Ontario 4-H Council

Head

The head should be in good proportion to the body. The forehead should be wide, and the jaw should be wide and strong. Teeth should be examined to be sure that they meet properly.

Shoulder Blades

The shoulder blades should be flat and smoothly blended into the body. They should be firmly muscled into the withers with no gap between the

tops of the shoulder blades and the withers. The point of elbow should be quite close to the body. It should not point outwards from the body (this is a sign of a winged or loose shoulder).

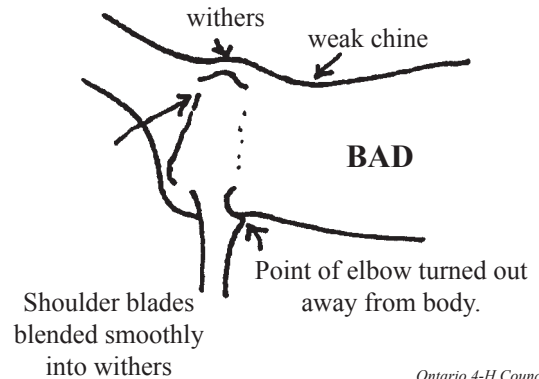
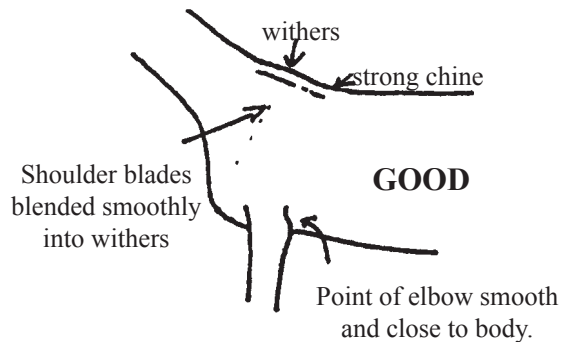

Ontario 4-H Council

Back

The back, usually called the topline on a goat, should be level. It should be strong in the area of the chine, and should not dip behind the withers. The loin should be strong and level, and blend well into the hip area. The hipbones should not stick out far past the loin.

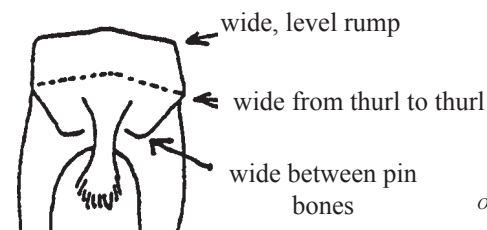
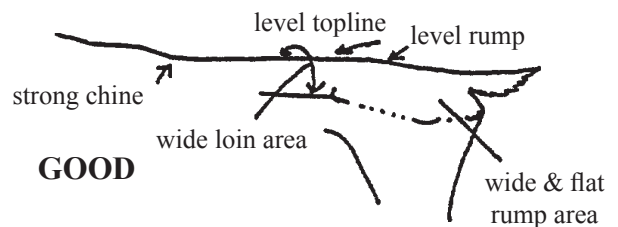

Ontario 4-H Council

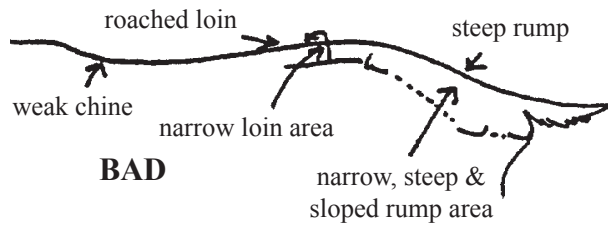

BAD



Steep rump.
A-shaped from thurl to thurl.
Narrow between thurls & between pins.

Ontario 4-H Council

Rump

The rump should be as level as possible from the hips back to the pin bones when viewed from the side. When you look at the goat from behind, the backbone should be just slightly higher than the thurls (the bones which are a few inches ahead of the pin bones on either side of the rump). The rump area should be wide with lots of space between the pin bones. This is a sign of a goat with a good wide area for udder attachment. A goat with a narrow, steep rump usually has legs set too close together to allow for proper space for the udder.

Feet and Legs

The front legs should be straight when viewed from the side. There should not be a forward bend at the knee. The knees should not be swollen or heavily covered by callous (signs of serious arthritis problems). From the front, the front toes should point straight ahead. The cannon bones should be almost as long as the upper leg from the knee to the point of elbow. The toes should be close together and not spread apart.

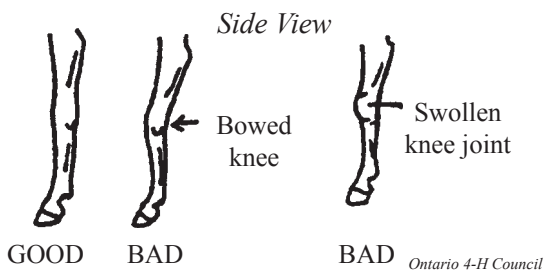

Ontario 4-H Council

Front View

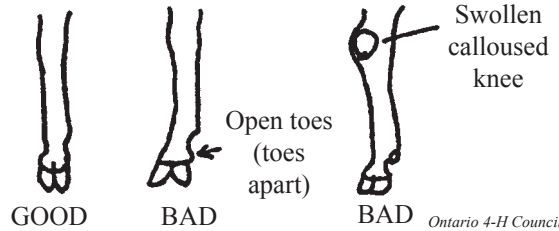

Ontario 4-H Council

The hind legs should be set well apart when viewed from behind. The hocks should not be turned inward toward each other. There should be lots of room for the goat's udder. When viewed from the side, the hind legs should be angled properly. When the goat stands in a relaxed position, a line drawn vertically from the pin bone to the ground should pass along the back of the hind leg.

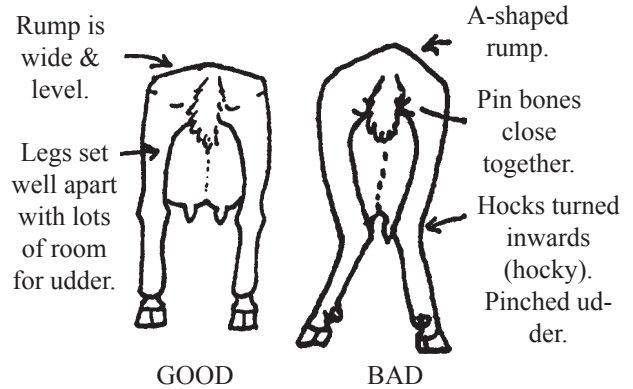

Level Rump

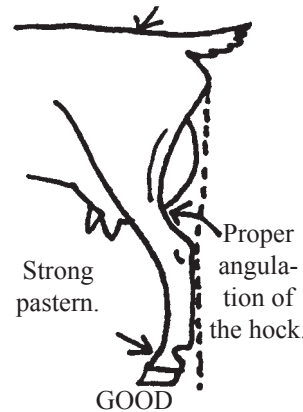

Steep Rump

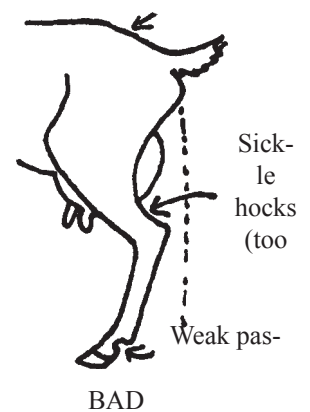

Ontario 4-H Council

Dairy Character

In judging, Dairy Character is considered to be those traits that are commonly identified with a good milk-producing animal. These traits are angularity, general openness, and freedom from excess fleshing. These traits can be

defined in the following way.

Animation

A goat which has a certain “lively” or perky look. It’s interested in what is going on around it. It adds a certain stylishness to the goat



“Animation” means lively and stylish.

Ontario 4-H Council

Angularity

The general sharp bone structure of the goat is apparent. All parts of the goat seem to be in balance with one another. Angularity does not mean that the goat is “bony”

General Openness

All parts well defined and cleanly boned.

Freedom from Excess Flesh

A goat carrying adequate weight for its age, stage of lactation, etc. but without extra fleshiness over the back and ribs, on the thighs, etc.

To help assess angularity, openness and fleshiness, each part of the goat must be examined for indications of Dairy Character.

Neck

Should be long and graceful and lean on a doe, but not so long or lean on a buck. The neck should not be too short or heavy.

Withers

They should be slightly higher than the shoulder blades, sharp and like an inverted “V”. The shoulder blades should be firmly muscled to the withers but without excess flesh. There should not be hollows between the withers and the

shoulder blades, as this would denote poor shoulder muscles.

Ribs

The rib bones on a dairy animal are very wide and quite flat feeling. There should be adequate spacing between the ribs – you should be able to feel between the ribs. The ribs should also be well sprung a sign of good body capacity. The ribs should also be long as this helps to give an animal more depth in the barrel.

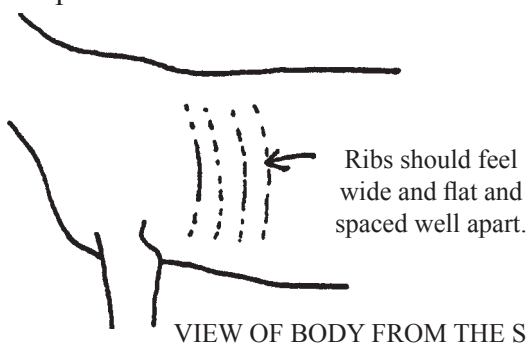

BODY VIEWED FROM ABOVE.

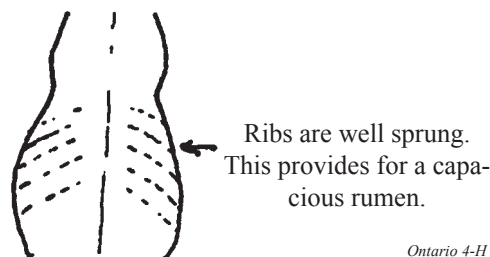

Thighs

The thigh bones should be flat. When you look at the goat from behind, the thigh should be lightly muscled (over flat bone), never carrying heavy fleshing. The thigh bone should also be gently curved to allow room for the udder. On a meat-type goat, the thigh should be more muscled.

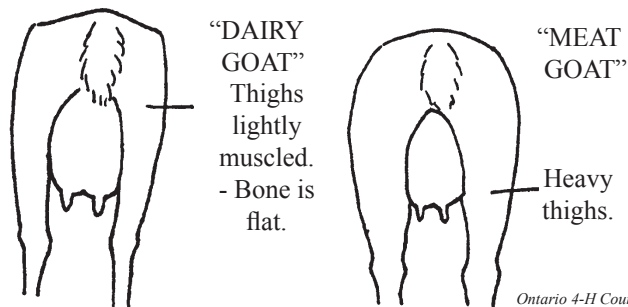

Skin

On a dairy animal, the skin will be very fine and pliable. This will be particularly evident on a clipped goat. Gently pinch a fold of skin over the goat's ribs and roll it between your fingers. The skin on a good dairy goat will seem very thin and very soft when rubbed between the fingers in this way. The skin should also seem loose when you rub your hand around on the back and neck (it should never seem tight and stiff).

Compare many goats to each other to learn how to recognise Dairy Character. When you see a very good milker, look at her and keep these points in mind. See how many of them she will score highly on.

Body Capacity

Body Capacity is judged by the size of the goat's body in relation to the overall size of the animal. A goat that has a large body capacity would be expected to eat more food, digest the food better, and make more milk or mohair or grow faster. It would also have more room for its heart and lungs and should be a healthier animal because of this.

When we evaluate Body Capacity, there are two areas that we usually look at.

The Barrel (The area covered by the ribs which contains the abdomen).

When you look at the goat from above, the barrel should in fact look almost like a barrel. The size of the barrel changes depending on how much food the goat has consumed lately, but even a goat which has not eaten recently should still have ribs which round out well from the topline. When you look at the goat from the side, the body just ahead of the hind legs should appear to be deeper than the body just behind the front legs. (i.e. this is called wedge shaped)

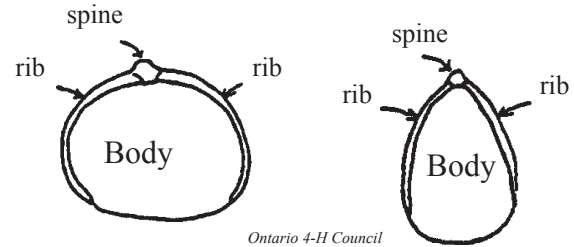

Good 'spring of rib'. Ribs are long, wide and flat. They 'spring' outwards from the spine. This results in good body capacity.

Poor 'spring of rib'. Ribs are short, narrow, and rounded. They do not spring outwards from the spine. This results in poor body capacity.

The Heart Girth (The area behind the front legs – it usually refers to the circumference of the animal measured just behind the withers).

The heart girth should be large with lots of room for the lungs and heart. When you look at the goat from the front, the chest floor should be wide (the front legs should not appear to "pinch" together at the chest). The area between the base of the neck and the bottom of the brisket should be very deep. When you look at the goat from the side, the brisket should extend well out in front of the

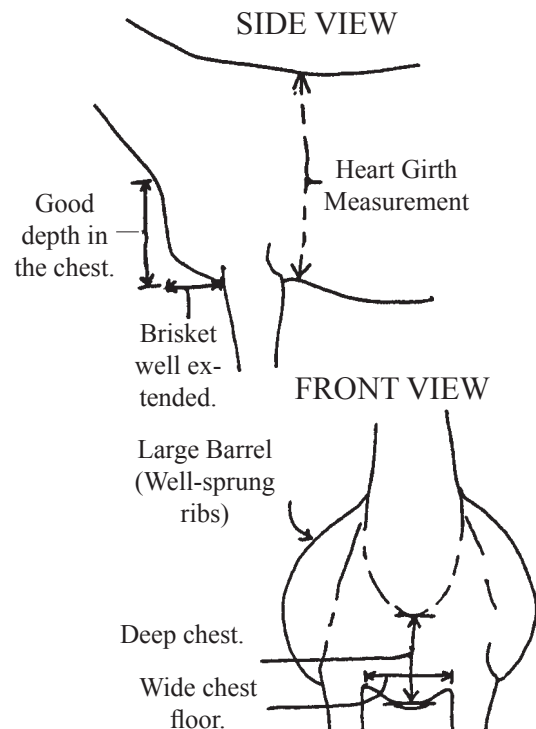

These two areas of the goat should help us to judge Body Capacity. Compare several goats to one another. Take note of the depth of the chest below the base of the neck. Measure heart girths of animals of similar ages.

Mammary System

On the Doe Scorecard, Mammary System (udder) is worth a total of 35 points. Mammary System is not on the Buck Scorecard. When judging goats, the mammary system is broken down into several categories with different point totals for each category. They are:

- Medial suspensory ligament, shape, texture, teat placement combined = 15 points
- Rear udder attachment = 8 points
- Fore udder attachment = 8 points
- Teats (size, shape and placement on the udder) = 4 points
- TOTAL = 35 points**

When evaluating the goat’s mammary system, it is easiest to look at some of the different parts that combine to make a good udder.

Capacity, Shape and Texture

Is the udder in proportion to the body size of the goat? Is it large enough for a goat that has freshened the number of times it has? Is the udder round and globe shaped (the correct shape of a good udder)?

Good Udder

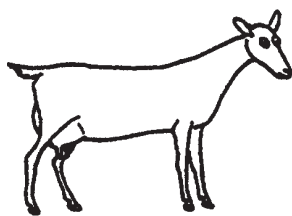

A good udder is globe-shaped, tightly attached to the body, and carried well above the ground.

Poor Udder

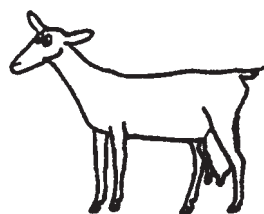

A poor udder is not globe-shaped, has poor attachment to the body, and may be too close to the ground.

Ontario 4-H Council

The udder should be very soft to the touch, fine and pliable (never tough and leathery). The udder should feel soft inside and should not have hard areas left by mastitis or injuries. The udder should not be filled with rubbery fleshy tissue (a meaty udder). After milking, the udder should collapse down almost next to nothing.

Rear Udder Attachment and Balance of the Halves

Is the udder high and wide at the back? It should blend smoothly into the body slightly below the pin bone area. Is the udder balanced? Are both halves the same size? The medial suspensory ligament that divides the two halves of the udder should be well defined and should lift the centre portion of the udder slightly. When you look at the goat from behind, the udder should not be flat or bulged downwards between the teats. It should go up a little between the teats and the teats should point straight down and not out to the sides.

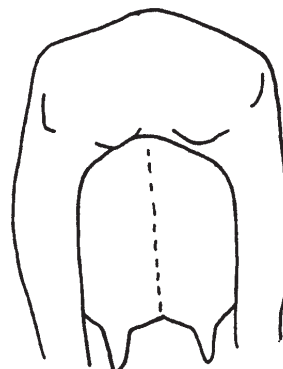

REAR VIEW of a good udder showing high, wide rear attachment. A strong medial suspensory ligament creates a good udder floor. Teats point straight

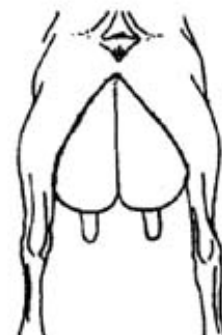

REAR VIEW of a poor udder with narrow and broken down rear attachment. Funnel-shaped teats.



REAR VIEW of a moderately attached udder. Poor medial suspensory ligament causes the udder floor to sag downwards and teats to point out to the sides.

Ontario 4-H Council

Fore Udder Attachment

Does the udder extend forward well? It should blend smoothly into the area below the barrel. There should not be a large “pocket” or groove at the front of the udder when it is full of milk. The udder should be strongly attached at the front and sides (where it blends up to the body between and just in front of the hind legs).

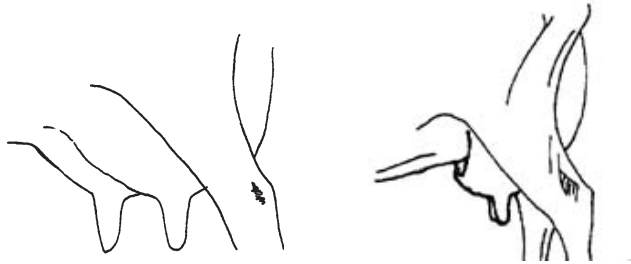

SIDE VIEW of a smoothly attached fore udder. Note how the udder blends smoothly into the lower abdomen. Teats are well placed and pointing down correctly.

SIDE VIEW of a poorly attached fore udder. Note how the front of the udder is broken away from the body of the goat. A large ‘pocket’ is visible in the front of the udder.

Ontario 4-H Council

Teats

The teats should be equal in size. They should be a size that is easy to milk without being too large or long. When the goat is standing normally, the teats should be placed on the udder so that they are just slightly ahead of the hind legs when viewed from the side. When viewed from behind, the teats should be set wide apart and pointing directly down (not out to the sides).

Teats should be normal in size...



From behind...

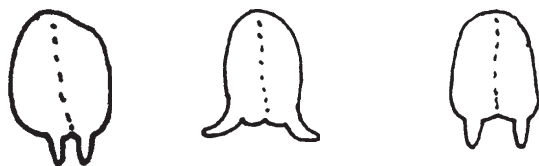

Teats should n o t be t o o close

Teats should n e v e r point out to the sides.

Good teats point straight down. They are not too close o r too far apart.

From the side...

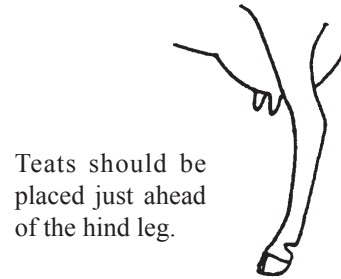

Teats should be placed just ahead of the hind leg.

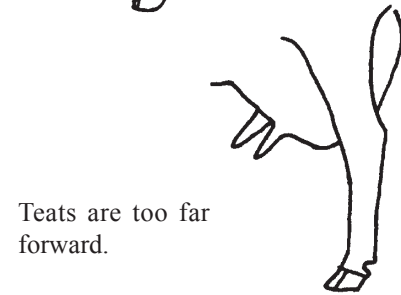

Teats are too far forward.

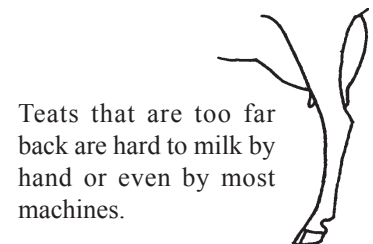

Teats that are too far back are hard to milk by hand or even by most machines.

Ontario 4-H Council

DAIRY GOAT JUDGING TERMS

General: Appearance to be feminine and alert. Coat to be fine and short. Hide loose and pliable.

1. Head: Feminine, moderately wide tapering to a strong muzzle. Front teeth should meet the pad of upper jaw.
2. Eyes: Rather large, clear and bright.
3. Throat: Fine. With or without wattles.
4. Neck: Long and slim, not coarse.
5. Withers: Neat and sharp, shoulders fine, blending smoothly into the body.
6. Topline: Long and showing strength.
7. Forelegs: Strong, straight, set well apart.
8. Pasterns: Upright, medium length, springy.
9. Hooves: Well-shaped, trimmed level.
10. Teats: Just large enough to grasp comfortably, symmetrical, cylindrical, pointed slightly forward.

11. Udder: Globular, capacious, attached over a wide area, free from fleshiness, flexible and fine of texture. Well-attached forward, with no cavity between halves. Spherical at rear, attached high and broadly, not pendulous. Halves symmetrical smoothly joined.
12. Milk veins: Preferred prominent and tortuous.
13. Barrel: Large, capacious, held up firmly.
14. Chest: Fairly deep, good width between shoulders, providing good lung capacity.
15. Pelvic Structure: Broad, good width between pin bones.
16. Rump: Broad and long with moderate slope.
17. Escutcheon: Wide and reaching high.
18. Rear of udder: Halves blended to globular shape, extending slightly beyond the hind legs.
19. Hind leg structure: Good width between legs, hocks slightly curved to give ample room for udder. No tendency to being cowhocked. Legs strong, well up on pasterns.
20. Rib cage: Deep and well sprung, with a good shape between ribs.

EVALUATION OF DEFECTS

A. Head

1. Large scurs or stubs – moderate fault.
2. Natural horned – serious fault. (neatly disbudded or dehorned – no discrimination)
3. Crooked face – moderate to serious fault depending on degree.
4. Undershot or overshot jaw – minor to serious fault depending on degree.

B. Fore Body Conformation

1. Loose, winged, or heavy shoulders – moderate to serious fault.
2. Narrow chest or pinched heartgirth – moderate to serious fault.

C. General Body Conformation

1. Short, shallow, or narrow body – moderate to serious fault.

2. Low-backed or steep-rumped – moderate to serious fault.
3. Broken or wry-tail – slight fault.

D. Legs and Feet

1. Enlarged knees, non-disabling lameness, turned out or crooked feet – all moderate faults.
2. Small-boned for body size, bowed over front legs, buck kneed, hind legs close together, or sprung pasterns – all moderate to serious faults depending on degree. (More serious in bucks)
3. Very crooked or malformed feet and very strong cow-hocks – all serious faults.

E. Mammary System

1. Front, rear or side udder attachments lacking; pendulous udder; bagged too tight to feel udder texture; large or leaking orifice; an extra teat that has been cut off; double orifice in teat; teats not clearly separated from udder; udder hard or swollen (except in does just fresh); an udder so uneven that one half is less than ½ the size of the other – all these are serious faults.
2. Udder that is lacking in size and capacity in relation to size of doe – very serious fault.
3. Separation between halves or presence of scar tissue – slight to serious fault depending on degree.
4. Large pocket or beefy texture – moderate fault.
5. Teats set close together, bulbous, very small, or large, pointed sideways, uneven in size, having small streams or otherwise hard to milk are all moderate faults. Extra teats are a serious fault.

Dairy Goat - Buck Scorecard
From the Canadian Goat Society Judge's Manual

GENERAL APPEARANCE

TOTAL 54 POINTS

Attractive individuality indicating masculinity, vigour and strength with a harmonious blending and correlation of parts; Impressive style and attractive carriage; graceful and powerful walk.

STYLE	Graceful appearance; smoothness of blending throughout, especially the shoulder blades which should be set smoothly against the chest wall and withers; full in the crops.	8
BREED CHARACTERISTICS & HEAD	Appropriate for the breed.	8
BACK	The back strong and appearing straight; chine and loin broad, strong and nearly level.	8
RUMP	Long and wide, nearly level from hips to pins and thurl to thurl; hips wide and level with the back; pin bones wide apart, nearly level and well defined; tall head set slightly above and neatly between the pin bones; tail symmetrical with the body.	10
FEET & LEGS	Legs wide apart, squarely set; bone flat and flinty; tendons well defined. Pasterns of medium length, strong and with some spring. Feet pointed forward with closed toes, deep heel and level sole. Forelegs straight with clean knees. Hind legs nearly perpendicular from hock to pastern when viewed from the side; high and wide in the escutcheon with legs straight and well apart when viewed from the rear. Hocks clean.	20

DAIRY CHARACTER

TOTAL 23 POINTS

Animation, angularity, general openness and freedom from excess fleshing.

Neck long and lean. Throat clean. Withers well defined and wedge shaped, rising above the shoulder blades. Ribs wide apart, bone wide, flat and long. Flank deep with arch well defined. Thighs incurving to flat when viewed from the side. Loose, pliable skin with fine hair.

23

BODY CAPACITY

TOTAL 23 POINTS

Relatively large in proportion to the size of the animal, providing ample digestive capacity, strength and vigour and showing desirable length of body.

Width throughout beginning with the head and carried through the chine and loin. Barrel deep and strongly supported, ribs well sprung with depth and width tending to increase towards the flank. Heart deep and wide with well sprung foreribs; chest floor wide; fullness at the point of elbow.

23

TOTAL

100

MEAT GOAT JUDGING

Conformation

Meat goats should be evaluated on “type” and “market desirability”. These terms refer to frame size, skeletal correctness and how these blend in the market animal. “Market desirability” relates how much finish the goat has in relation to its weight, size and age.

A good market goat should be rectangular in appearance from the side with straight, level top and bottom lines. Length of rump, length of body and length of leg are important to market desirability. The rump should be level and the overall body should be trim. The legs should be straight and placed square under the body, not post-legged or cow-hocked. The fore and hind legs should show evidence of muscling.

From the front, a market goat should show width between the forelegs, muscling in the forearm and shoulders, trimness in the brisket or breast area and soundness and correctness in the front feet and legs. The head should be in proportion to the neck and body.

From the rear, the hindquarter should be muscular and long and the back, loin and rump should be uniform in width. The feet and legs should be straight and spaced square and wide under the goat.

General Appearance

Stature: The term stature refers to the overall skeletal size and length of the goat. Goats must have an adequate length of cannon bone from knee to pastern and should be above average in overall length of body and general size. Cannon bone length is a good indication of skeletal size. The goat’s height measured at the withers should be slightly more than at the hips, and bones must be of good size.

Head: The head should combine the beauty of eyes, nose, ears, and overall form with strength and refinement. It should have a balance of length, width and substance that insures an ability to consume large amounts of forage with ease.

Front End: The front end is a combination of chest and shoulder features. The goat should have a wide chest floor and prominent brisket with a smooth blending of shoulder blades and sharp withers. This insures room for the heart and lungs to do their work with ease and also is evidence of proper muscle and ligament strength.

Front Legs: The goat’s front legs should be straight, perpendicular to the ground, sound in the knees and full at the point of the elbow. The legs should move with the front feet pointing straight ahead.

Back: A back that is straight, strong, wide, long and level is desired in goats. This denotes a strong body build with good muscling and is indicative of strength to carry large quantities of feed.

Rump: The goat’s rump should be long, wide and level from thurl to thurl, cleanly fleshed and have a slight slope from hips to pins. The shape of the rump is important as it affects leg set.

Hind Legs: The goat’s rear legs should be wide apart and straight when viewed from the rear, with clean hocks and a good combination of bone refinement and strength. Observed from the side, a plumb line originating at the pin bone would fall parallel to the leg bone from hock to pastern and touch the ground behind the heel of the foot. The resulting angles produced at the hock and stifle joint will be most ideal for easy walking and a minimum of joint problems.

Feet: Meat goats need strong pasterns and strong, well-formed feet with tight toes, deep heel and level sole. Such feet are highly resistant to injury or infection and easy to keep trimmed. Goats with uneven toes and extremely weak pasterns should be culled.

Muscle

Meat characteristics can be visually determined by examining the animal hindquarters, loin, shoulders and neck.

Hindquarters: A long, deeply attached muscle, relatively thick at the thigh and stifle is desirable in meat goats. Heavier muscling on the outside of the leg is acceptable. Muscle over the thurl and rump should be obvious.

Loin: The loin eye or ribeye is typically the best indicator of meatiness in market goats. It should be wide with a symmetrically oval shape on each side of the backbone. This muscle should carry forward over the ribs or rack.

Shoulders: The goat's muscling should increase from the withers to the point of the shoulder with the thickest muscle occurring immediately above the chest floor. The circumference of the forearm is the second most important indicator of meatiness, so the forearm muscle should exhibit a prominent bulge and should tie in deep into the knee.

Neck: The juncture of the neck and shoulder should be free of excess tissue. It should gently slope to indicate muscling. Smoothness and quality are important in this area. A long clean neck with muscling in balance to the remainder of the animal is desired.

Condition

The term condition refers to the amount of finish or fat the animal is carrying. Goats deposit fat internally before they do externally. The ideal condition is a thin, but uniform, covering over the loin, rib and should. The external fat thickness over the loin at the 13th rib should be between .20 to .30 centimetres or average .25 centimetres.

Pygmy Goat Scorecard
From the Canadian Goat Society Judge's Manual

GENERAL APPEARANCE - Total Points	DOE	BUCK
STYLE: Attractive individuality indicating femininity (or masculinity); vigour, strength & healthy condition, with a harmonious blending and correlation of parts; impressive style and attractive carriage, graceful and powerful walk.	30	30
TOPLINE:	(6)	(6)
BACK: Back strong, broad and level across chine and loin.	(8)	(8)
RUMP: Rump medium long, medium wide and moderately sloped; thurls high and wide, tall symmetrical and carried high.	(8)	(8)
NECK & SHOULDERS: Smooth blending of the shoulder blades which should be set smoothly against the chest wall & withers; full in the crops; withers nearly level with the spine.	(8)	(8)
BREED CHARACTERISTICS -	22	30
HEAD: Expression alert and animated; medium head length; profile dished; muzzle broad and full; jaws broad, well-muscled and correctly aligned with bite neither under or nor overshot. Eyes set well apart, prominent but not protruding; ears medium sized and held erect.	(10)	(12)
BREED SPECIFIC MARKINGS: Breed specific markings; as per colour description.	(8)	(12)
COAT: Coat dense, hair straight, more abundant in bucks.	(4)	(6)

FEET AND LEGS -	18	22
Legs strong and well-muscled; wide part; squarely set. Forelegs straight, cannon bone short; hindlegs well angulated; hocks short; pasterns short, strong and resilient; feet well shaped, deep heel, level sole; knees and hocks clean. Wide in the escutcheon with legs well apart when viewed from the rear.		
BODY CAPACITY -	22	22
CHEST:	(10)	(10)
Chest floor wide, full at point of elbow and deep in the heart.		
BARREL:	(8)	(8)
Barrel broad and deep, ribs well-sprung. Capacity relatively large in proportion to the size of the animal, providing ample digestive capacity; strength and vigour with proportionate length of body.		
MAMMARY SYSTEM -	12	0
Does - teats symmetrical, cylindrical, functional; each with one orifice, free of obstructions. Udder balanced, firm, rounded and well attached with high wide rear udder and well extended for udder.		
Bucks - must have two single, normal, non-functional teats, each with one orifice; and normal testicles; both descended full and equal in size.		
TOTAL POINTS ALL SECTIONS	100	100

Boer Goat Scorecard
From the Canadian Boer Goat Association

	DOE	BUCK
GENERAL APPEARANCE - Total Points	35	35
A) QUALITY AND TYPE	(10)	(10)
Deep bodied and feminine (masculine) in appearance, showing great power and symmetry of form. Clean, strong bone. Smooth, well blended finish. Graceful. Powerful walk; impressive style and carriage. Topline should be straight and as level as possible. Does should have a well defined wedge shaped when viewed from the side. Buck MUST have two firm, fully descended testicles of equal size with a maximum split of 2.4 cm on a mature Buck. A Buck should also have a maximum of two teats per side, with ideal being one teat per side.		
B) BREED CHARACTER	(7)	(7)
Convex profile. With a Roman nose and pendulous ears. Head must be medium in length, strong and feminine (masculine) in appearance. Muzzle broad with large, open nostrils. Jaw strong even and correctly aligned with bite neither under or over shot. Eyes full and bright. Forehead wide. Ears must be of sufficient length and lay flat against head, not interfering with the eyes. Horns, if present, should be round and curving to the rear and out enough to allow head movement without the horns excessively rubbing the neck. The curve of the horn should follow the convex profile of the face. Dehorned animals shall not be penalized. Neck should be proportional to body size and thick at base, blending smoothly into shoulders and brisket;		

symmetrical and well-carried.		
- Traditional colouration consisting of white body, reddish brown on both sides of the head which is a minimum of 10 cm; ears must be 75% reddish brown; reddish brown may extend as far as the withers and brisket; body may have a reddish brown mark, should not exceed 15 cm. across in any direction.	(3)	(3)
C) SIZE AND DEVELOPMENT	(10)	(10)
According to age, preference being given to animals showing superior growth and muscle development.		
D) CONDITION	(5)	(5)
Well muscled with a smooth, even covering of firm flesh, healthy hair coat. In colder months, cashmere in the coat shall not be penalized. Skin loose and pliable.		
FORE QUARTERS - Total Points	15	20
A) SHOULDERS	(3)	(3)
Strong and well muscled with even covering of firm flesh; shoulder blades set smoothly against chest wall and withers.		
B) WITHERS	(3)	(3)
Slightly rounded and barely defined with even flesh covering; blending smoothly into the area of the chine.		
C) BRISKET	(3)	(3)
Broad, deep, muscular and firm.		
D) FORELEGS	(6)	(11)
Medium in length, wide apart, squarely set, straight and strong. Bones clean, strong and adequately proportioned to support weight; feet sound, short, wide and straight with a deep heel, level sole and closed toes. Strong pasterns are a must.		
BODY - Total Points	20	25
A) CAPACITY	(4)	(5)
Deep and wide throughout, providing ample digestive capacity, strength and vigour.		
B) HEART GIRTH	(4)	(5)
Large heart girth resulting from long, well sprung foreribs; wide muscular chest floor between front legs; fullness at point of elbow.		
C) BARREL	(4)	(5)
Uniformly deep, wide and strongly supported from front to rear, with well sprung ribs - wide, flat, long and widely spaced.		
D) BACK	(4)	(5)
Broad and strong with even covering of smooth, firm flesh. Topline strong, straight and nearly level.		

E) LOIN	(4)	(5)
Broad, strong and nearly level with even covering of firm flesh. Flanks deep and full.		
HINDQUARTERS - Total Points	15	20
A) RUMP	(5)	(5)
Long, broad and slightly sloping with smooth even covering of flesh. Hips wide apart and level with back. Thurls wide apart and nearly level from thurl to thurl. Pins wide apart and lower than hips. Tail head slightly above and neatly set between pin bones. Tail symmetrical with body.		
B) TWIST AND THIGHS	(4)	(4)
Twist deep, full and firm. Escutcheon low and wide. Thighs deep, wide, muscular and firm.		
C) HIND LEGS	(6)	(11)
Medium length; wide apart and nearly straight when viewed from the rear, nearly perpendicular from hock to pastern when viewed from side. Hocks wide apart when viewed from rear and showing correct angulation when viewed from side. Bones clean, strong and adequately proportioned to support weight. Strong pasterns are a must. Feet sound, short, wide and straight with a deep heel, level sole and closed toes.		
MAMMARY SYSTEM - Total Points	15	0
A) UDDER SHAPE AND CAPACITY	(4)	
Long, wide, extending well forward and showing adequate capacity with exaggerated size.		
B) FORE ATTACHMENT	(3)	
Carried well forward; tightly attached with out pocket; blending smoothly into body.		
C) REAR ATTACHMENT	(3)	
High, wide and strong; udder halves evenly divided and symmetrical with string medial suspensory ligament.		
D) TEXTURE	(2)	
Pliable and elastic, free of scar tissue; well collapsed when empty or dry.		
E) TEATS	(3)	
Uniform of desired length and size for nursing; well defined; free from obstruction; squarely and properly placed; easy to milk. One or two functional teats on each side are acceptable. A split teat is acceptable if it is not joined for more than 50% of its length. In all cases, the final judgement should be made according to whether the kid can successfully take milk from the teat.		
TOTAL POINTS: ALL SECTIONS	100	100

Market Kid Scorecard

From the Canadian Boer Goat Association

GENERAL APPEARANCE	Total Points	35
A) QUALITY AND CONDITION		(20)
Well muscled with a smooth, even covering of firm flesh, clean, strong bone. Healthy haircoat. Skin loose and pliable. No evidence of improper management of disease.		
B) SIZE AND DEVELOPMENT		(15)
According to age, preference given to animals showing superior growth and muscle development.		
HEAD AND NECK	Total Points	5
A) HEAD		(2)
Clear, bright eyes; large, open nostrils; no discharge from either.		(3)
B) NECK		
Medium in length, strong and thick at the base, blending smoothly into shoulders and brisket.		
FOREQUARTERS	Total Points	15
A) SHOULDERS		(6)
Well muscled with smooth, even covering of firm flesh; withers barely defined.		(6)
B) BRISKET		(3)
Broad, deep, muscular and well covered with smooth, firm flesh.		
C) FORELEGS		
Wide apart and squarely set with well muscled shank. Bones clean, strong and adequately proportioned to support weight.		
BODY	Total Points	22
A) CAPACITY		(2)
Providing ample digestive capacity without obvious enlargement.		(4)
B) HEART GIRTH		(8)
Large; wide muscular chest floor between front legs; fullness at point of elbow.		
C) BARREL		(8)
Uniformly deep, broad and strongly supported from front to rear, with smooth, even covering of firm flesh.		(8)
D) LOIN		
Broad and strong with even covering of firm flesh. Flanks deep and full.		23
HINDQUARTERS		
A) RUMP		(10)
Long and broad with a smooth, even covering of firm flesh.		(10)
B) TWIST AND THIGHS		
Escutcheon low and wide showing well flesh, deep twist. Thighs deep, wide, muscular and firm.		(3)
C) HIND LEGS		
Bones clean, strong and adequate proportion to support weight.		
Total Points - All Sections		100

Angora Scorecard

From the 4-H Cooperative Curriculum System, US Department of Agriculture and Cooperative Extension Services.

BODY - 40 points	Points
Size, weight for age, and substances of bone (minimum weights; yearling bucks, 80 lb.; yearling does, 60 lb.)	20
Angora breed type (head, horns, ears, hair cover)	10
Conformation (width, length and depth of body; level top line; and straight set of feet and legs)	10
FLEECE - 60 points	
Length of staple (one inch growth/month, uniform and high-yielding)	10
Fineness (uniform in grade over entire fleece)	15
Uniformity in type of lock (ringlets versus flat lock), completeness of covering (neck, legs and belly), and character of waves of staple	15
Luster and softness of fleece	10
Density of fleece (number of fibres per unit of area, minimum skin exposed when fleece is parted)	10

DISQUALIFICATIONS

BODY - dark horn or hoof; distorted horn; deformed mouth, feet and legs; swayback; and abnormal testes and scrotum

FLEECE - Excessive kemp; coloured hair; sheepy fleece, lack of fleece on cannon bones

Pack Goat Type Scorecard

From the 4-H Cooperative Curriculum System, US Department of Agriculture and Cooperative Extension Services.

STRUCTURAL CORRECTNESS	Points
GENERAL BODY (10)	40
Wide chest and brisket	
Body length is in proportion to height	
LEGS (20)	
Angular not post legged	
Strong pasterns perpendicular to ground	
Strong feet with tight toes	
Strong, easy, smooth gait	
BACK (10)	
Back vertebrae parallel to ground with open withers	
Strong chin and loin	30
MUSCULARITY	
Strong body - “working” goat appearance, not dairy type (10)	
Thigh/gaskin muscles well defined	20
ATTITUDE	
Shows a “pet quality” attitude to include a friendliness and will to work	10
COORDINATION	
Evidence shown to negotiate an obstacle	
TOTAL	100

PACK GOAT JUDGING by Allison Watt

At 4-H rallies and judging days, pack goat judging is still unheard of (in Canada). Hopefully someday there will be pack goats at judging events, but first members must learn the standards. Refer to the scorecard for pack goats on page 84. Practice on your own goats!

Judging pack goats is different than the judging of any other animal, and yet combines the aspects of dairy goat, pygmy goat, dog, horse and llama judging.

Where as a dairy goat is feminine, long-bodied and refined, a pack goat should catch the eye as a powerful, muscular and well-proportioned animal. He should possess a kind, willing nature, and be obvious as a working animal.

Castrated male goats, called wethers, are most often used for packing, but many people also use does. However, it should be noted that a doe with a large, globular udder would be faulted as a pack goat, as her udder will hinder proper movement as well be a target for twigs, fences and rocks.

The pack goat scorecard is broken down into four main parts: Structural correctness, Muscularity, Attitude and Coordination.

Structural Correctness

General Body: The head should be strong, with alert eyes and ears, and a correct jaw. The neck should be medium length, showing muscling. The hips and thurls should have a “drafty” appearance. On an adult goat, there should be a finger length between each rib. The chest and brisket should be wide, as should the heart girth and barrel. The overall body should be well balanced, with the length proportional to the height and width.

Legs: The overall length of the leg should appear longer than the depth of the body from the withers to the bottom of the chest. The legs should be

angular, with bends in all joints from the hip down. The pasterns should be high and perpendicular to the ground. In the hind legs, a degree of “hockiness”, where the hocks come inwards, is desired, as this improves the goat’s agility. The elbows should not wing out when the goat is on the move, and the goat should overstep well (called “tracking up”.)

Back: The withers should be open. The back vertebrae should be parallel to the ground, with strength through the chine and loin. The rump should be wide.

Muscularity

The pack goat should be stocky and muscled in appearance. The shoulders and neck should be well-muscled and strong. The thighs and gaskin muscles should be well defined. Large size is desired in pack goats, but it is better to have a smaller, strong, muscled animal, than a huge animal that is out of proportion.

Attitude

The pack goat should be friendly and willing to work, with a pet quality attitude. He should be obedient and well behaved.

Coordination

There will be an obstacle selected for the goat, depending on his age, which will test his ability to negotiate common trail obstacles.

PACK GOAT

Member Manual Supplement by Allison Watt

Introduction to Goat Packing

The idea of using a goat as a pack animal may seem unfamiliar, unusual or just plain weird. However, it actually makes perfect sense. Goats are small, easy to handle and transport. Their purchase, maintenance and equipment costs are lower than those of other pack animals, as is their environmental impact. Best of all, goats love people, and their presence adds a unique and enjoyable element to any hiking or camping trip.

Why Pack With Goats?

Goats are the ideal trail animals for those who want a small, easy to manage and relatively inexpensive animal to share their hiking experiences. Most people choose to pack with wethers, or castrated male goats. These can weigh up to 300 pounds, but their maintenance is easier than does. They tend to eat less and don't experience the problems and demands related to kidding and lactation.

Equipment for pack goats includes cross buck packs, soft packs, halters, collars, leashes and panniers, all of which are cheaper to buy than equipment for other, larger pack animals. The most rewarding aspect of pack goats for many is that they truly enjoy being with people. Whether you choose to bottle feed your baby pack goat, or raise it with the dam, a properly bonded packer will follow you willingly without being on a leash.

What Breed Should You Get?

There are six recognized breeds of dairy goats in Canada: Alpine, Saanen, Toggenberg, Nubian, LaMancha and Oberhaasli. All of these breeds have been used successfully for packing, although seasoned goat packers all make varying claims and pick favourites.

Saanen: Often large, with mellow easy-going personalities. One potential drawback of the Saanen is his pink skin, which makes him susceptible to sunburn. Also, during heavy work in very hot weather, dehorned Saanens may

overheat. I have raised two Saanens and found them to have wonderful temperaments, bond well and work hard.

Alpine: Alpines are good sized goats well suited to the mountains. They are alert, watchful and come in many pretty colours and patterns. Some say they have a tendency to aggressiveness or nervousness, but they grow to a good size for packing and are hard workers.

Toggenberg: Midsize, powerful goats. They are also very alert and watchful, and some people find them more independent than other breeds. They have a typical coat colour that can range from light tan to dark chocolate and white face pattern that is very deer-like.

Oberhaasli: People who pack with Obers say they are calm, good natured hard workers. Some have also been found to like swimming. Unfortunately, they are rare in Canada. They have a standard reddish brown coat colour with black dorsal stripe and black legs and face markings.

LaMancha: If you can get over their somewhat odd appearance (the famous earless breed), be prepared to love LaManchas. They are intelligent, generally good natured goats, and my personal favourites. If you own and pack with LaManchas, you will get lots of practice constantly fielding the question: "What did you do to their ears?" They come in all colours and patterns.

Nubian: Despite being a very popular dairy goat, the Nubian has a somewhat tarnished reputation in the pack goat world as noisy, lazy and stubborn. Some people manage to pack with Nubies (I had one myself), but rare it is to find a goat packer who will recommend taking a chance on one. Nubians have distinctive hanging ears and Roman noses, and come in all colours and patterns.

There are also other breeds of goats:

Pygmy and Nigerian Dwarf: These are miniature breeds. For obvious reasons, they are not used for serious packing. However, many people enjoy day hikes with their small friends.

Cashmere and Angora: These are fibre breeds. Also not usually used for packing because of

their small size and excess hair coat.

Boer: This is a meat breed. More and more goat packers are experimenting with Boer crosses as packers, with mixed results.

Crossbreds are very popular among goat packers, combining the best of several worlds and adding a little hybrid vigour.

Acquiring a Pack goat

Purchasing a pack goat and his equipment is generally inexpensive compared to other pack animals. A buck kid can be bought from \$5 - \$25 from a dairy breeder, although in this case there is no guarantee that the animal will be good for packing. Pack goat breeders often are the better choice for baby shopping. Although this is not a sure-fire way of ending up with a super packer, you at least have the advantage of the fact that the babies were bred specifically for being pack goats. Pack goat breeders will sell kids for around \$100 or more, with the goat becoming more expensive for each year of training. For new packers who are serious, it may be worth the extra money to buy an older, more experienced packer.

Many serious goat packers prefer to leave the natural horns on their goat kids. Horns serve many important functions on a working animal. It has been scientifically proven that a working goat loses up to 12% of his body heat through the base of the horn. Goats have even been known to dig their horns into cool dirt on very hot days. The Nubian, a breed originally from the desert, loses heat through his large ears. Horns also serve as predator protection. However, 4-H and dairy goat show rules in Canada prohibit horns on animals. This rule makes sense for many people. Horns can be dangerous to other goats and people, and they often get caught in feeders or fences. Have your kid properly dehorned before he is three weeks old.

You will want to have your buck castrated to prevent the rather unpleasant habits developed by a mature buck. There are several castrating methods available: banding, Burdizzo and surgical. Banding involves placing an elastic band around the testicles, and then they will atrophy and fall

off. Opinions vary on what age to do this, but in my experience the older the baby the better for him. Three months is the age in which the buck reaches sexual maturity, at which point the urinary system is fully developed and will aid in the prevention of stones. This method has the potential to cause infection and so the buck should be closely monitored. Also, after about three months the testicles may be too big for this method. Burdizzo castration involves crushing the spermatic cord with pliers. It is fast and bloodless. Surgical castration involves cutting the scrotum and removing the testicles entirely. Whichever method you choose, if you have not done it before, ALWAYS consult someone who has experience to reduce your goat's suffering as much as possible.

What to Look For

Basically, a pack goat should catch the eye as a powerful, handsome, alert animal. He should be "drafty" in appearance, as opposed to "dairy". He should have evidence of good muscling and strong bone. Attitude is also extremely important when choosing a packer. He should be gently, friendly and willing to work. Many of these qualities will be difficult to spot in a very young kid. In this case, you should look for a kid that is healthy, with clear eyes and nose, inquisitive and playful, as well as of a good size. For more on what to look for in a pack goat, see "Judging Pack Goats".

On the Trail

Goats, unlike other pack animals, seem to have a built in instinct to follow humans. Generally, pack goats will follow their hikers without leads, including (with proper training) through ponds and rivers, over bridges and up steep cliffs.

Transporting Your Goat

One of the many benefits of hiking with goats is that they are easy to transport. One or two goats can travel in the back of a car or van (I have had four goats and a dog in the back of my small car, but this is not recommended.) People with more goats can use a pick-up truck with a canopy or stock rack, a small trailer, or even a horse trailer.

Goats are usually easy to teach to load, and will travel well. It is not recommended to tie goats up while transporting them, as they are experts in tangling themselves, and can possibly be hung.

What to Expect on the Trail

Goats don't need extensive training to head out on the trail; I have taken several goats out that had never hiked before, and by the end of the day they were carrying the pack like a pro. However, it is a good idea to teach your goat a few basic commands like "no", "stand", and to come when their name is called. They should also be conditioned for longer hikes and overnights by going on shorter day hikes first, just like people.

Once you are on the trail with your goats, you should be able to concentrate mostly on enjoying your trek. However, it's a good idea to keep an eye on your packers, especially when hiking with new goats or in areas with poisonous plants. With new goats, it may take them awhile to learn how to follow right away, they may want to stay in familiar surroundings (i.e. by your car) and just eat. They may also eat a lot from the surrounding brush at the beginning of the hike. It may be necessary to lead them for the first while, but they should soon get the hang of it. Once they discover that they are free in the woods, they will frolic, jump, climb and generally act as they would in the wild. It is a good idea to take your camera to capture the unique moments, such as five goats realizing at once that you are ahead of them on the trail and all come following you at a dead run, or a goat attempting his first water crossing!

Overnight

When camping overnight, techniques vary on how to bed down your goats. Some people just let their goats loose, perhaps attaching a bell or two to keep track. In areas with predators, or people who have dehorned goats, they may prefer to "highline", or make a clothesline and attach the goat to it. Either way, it is important that your goat have shelter from wind and rain; a simple tarp will do.

Feeding on the Trail

Feeding your goats is relatively easy on the trail. They will browse along the way and when you stop to rest, so on short hikes it is not necessary to pack in any food. Some people like to bring grain or alfalfa pellets on longer hikes, for treats or energy boosts.

Water is very important for hiking wethers. They may take a while to adjust to drinking from a stream, so practice with them. On a long hike, you will have water packed with you, but it is much easier to have goats who can find a natural water source, so you can save the transported water for yourself.

Trail Dangers

Poisonous Plants

One of the main risks of hiking with goats is poisonous plants. Goats instinctively avoid some poisonous plants, but those they are unfamiliar with, taste good (or if the goat is very hungry) may be devoured. You must always keep an eye out on the trail, and in the campsite, for what your goat is eating. Poisonous plants can be found almost anywhere and some taste good. One advantage to goats is that they browse little bites along the trail, and so may not get a whole load of poison all at once. However, at camp they may indulge, and some plants cause poisoning over a period of time. A short list of poisonous plants likely to be found while hiking follows: oak, elderberry, stone fruit, ground hemlock, yew, pine (may cause abortion in pregnant goats), lupine, scotch broom, andromeda, azalea, rhododendron, laurels, iris, daffodil, buttercup. For an extensive list of poisonous plants, picture, and treatments, see PRACTICAL GOAT PACKING by Carolyn Eddy.

Don't be paranoid, but do keep an eye out. I hiked once with four wethers and a pregnant doe. We found a fallen pine tree, and the wethers pigged out. However, the doe took a few bites and then moved on.

Predators

There is no sure-fire way to prevent predator

encounters while hiking with pack goats. Fortunately, attacks are rare. Hiking with large groups of people is one way of avoiding predators, as they will hear you coming and vanish. Some people hike with dogs as a precaution; however, this will also diminish the number of peaceful wildlife you will see; many wild animals are intrigued by the goats. Predators are a good reason to have horned goats, as they can be quite effective at defending themselves. Other people carry pepper spray or guns. Sadly, the majority of goats attacked on the trail are killed by domestic dogs. Keep your goats close by you if you see dogs. Leash your goats if the dogs appear to be free. You can yell to alert the dog owners that you have goats. If they ignore you and the dogs intend to attack, most people use any method necessary to defend their goats, including sticks, spray or even their guns. Try to use these only as last resorts. The type of predators in your area, the number of goats you hike with, and the length and distance of your hike are all factors to take into consideration when determining your predator protection.

Trail First Aid

If an attack happens, or other accidents, you should be prepared, in order to reduce your goat's suffering as much as possible until you can reach veterinary assistance.

You should carry on yourself the 10 essentials of hiking in case something happens to your goat.

- 1) First aid kit
- 2) Extra food and water
- 3) Map and compass
- 4) Tinder kit
- 5) Extra clothing
- 6) Knife
- 7) Whistle
- 8) Signal mirror
- 9) Space blanket
- 10) Flashlight

Goat First Aid Kit for the Trail

PEPTO BISMOL - 20 cc per 50 lbs, once an hour. Pepto Bismol is good for bloat, upset stomach or possible poisoning.

VET WRAP - For covering large wounds. Disinfect area, apply dressing then secure with vet wrap, not too tightly. Also good for sprains, lameness.

DRESSING

HYDROGEN PEROXIDE - Wound cleanser.

WOUND OINTMENT / BLOOD STOP POWDER

ELECTROLYTES - 2 tsp/20 cc to 50 cc per 50 lbs. For heat exhaustion, hard hikes or diarrhea.

MINERAL OIL - 15 cc per 25 lbs. For bloat or constipation.

MUSCLE BALM - Horse or human type. To aid stiffness or prevent it. Rub in well so the goat cannot lick it.

SYRINGE - For dosing.

EYE DROPS - For eye injury, foreign body in the eye or dry or teary eyes.

BUG BITE LOTION

You may wish to add other items to your trail first aid kit, this is just a suggested minimum.

If on a long distance hike, you will also have to consider trail euthanasia. You need to be prepared to make the best decision for your goat's welfare in the even of a serious accident far from home.

Trail Etiquette

Generally, the rules of hiking are easy to remember and follow. Take out what you take in, and leave as little sign you were there as possible.

When hiking in an area where others are using the trails, the general rule is to yield to anything larger than you: i.e. horses, llamas, donkeys. The reasoning is that it is easier for you to get off the trail to let them by. If you do encounter larger

animals, it is a good idea to hold your goats and warn the other packers that you have goats, as their animals may be alarmed. Sometimes they may request to introduce their animals to your goats for a new experience.

Human hikers should, for etiquette's sake, yield to you. However, they may be so shocked by the sight of pack goats that they will forget. Be prepared to stop and chat with curious outdoors people (particularly those with massive backpacks.)

If you are in an area where you may encounter ATV's, motorbikes, Ski-doo's, or 4X4 trucks, be alert. Sometimes these drivers will not see your goats, or simply disregard them. Goats will usually be frightened enough by the noise to stick with you, but watch out anyways.

Caring For Your Packer

Feeding

There has been much debate on the subject of feeding wethers. This is because they are prone to the development of urinary calculi (stones) if the calcium:phosphorous balance of their diet is out of balance. It should be 2:1. The scientific world and goat owners alike have been unable to find any sure-fire way to prevent stones, but many have suggestions. Some people never feed grain, some never feed alfalfa, some prepare their own special grain mixes, etc. I can't tell you exactly what you should feed your goats to prevent stones, but I will make a list of things you should definitely do to keep your wether healthy.

- Feed approximately 2 - 3% of your goat's body weight each day (3/4 roughage, 1/4 concentrate). Be sure each goat is getting his share, as some are bullies.
- Monitor your goat's weight. A fat goat is just as unhealthy as a skinny goat.
- Feed only good quality hay. Whether you decide to feed alfalfa, grass, or a mix, it should have no mold, no dust, and as few large stalks as possible.

- If you feed grain (recommended for growing goats, working goats, and goats in cold weather) check the Ca:Ph balance.
- Try to provide natural forage, i.e. tree prunings, brush, garden leftovers. It is even better to take your goats out on foraging walks, so that they can select what they need.
- Provide salt and minerals.
- ALWAYS have fresh water available. This is especially important in winter, when warm water should be provided to encourage drinking. Water is important to prevent stones, and goats can die quickly if deprived of drinking water.

Housing

Ideally, goats should have about 100 sq. feet of space each, but many people don't have so much room. If your goats are exercised regularly and kept entertained, less space is fine.

Good fencing is very important. As pack goats tend to be large, you will need at least five feet, maybe more. If you have goats that enjoy climbing fences, you may want to reinforce your wire or rails with electric tape. If you have horned goats, make sure that they can't get their heads caught in your fence!

Goats are hardy and can stand cold, but not draughts. Make sure their shelter is at least three sided and windproof. If your goats all get along, the smaller the shelter the better as they will all cuddle together to keep warm. Shade is equally important, especially for sun burning Saanens.

Feeders should be designed to eliminate as much wastage as possible (goats are messy, fussy eaters!) and to make cleaning easy. Water should be in a place where it will not be contaminated by droppings.

Grooming and Maintenance

Pack goats don't need regular brushing or baths, nor should they be body clipped. However, before

saddling up, you should insure that the saddle and strap areas are free of dirt, as it could cause sores. If your goat has exceptionally long hair, it may be a good idea to trim it, especially in the saddle areas. This will prevent rubbing and tangling, both with the saddle and with brush.

Maintenance of the feet is especially important with pack goats. Feet should be trimmed approximately every 3 weeks (more or less depending on the goat) and checked before hikes. Improperly cared for feet can cause lameness, joint damage and a loss of the goat's ability to climb rocks properly.

Your goats should be dewormed regularly (2 - 4 times a year). With wethers it is safe to use oral ivermectin, in dosages according to their weight. Some people choose to alternate chemical types of dewormers to decrease resistance. Talk to your vet or an experienced goat keeper for more information. Most people don't give their goats regular vaccinations, but it is still a good idea to know how to give shots in case of emergency tetanus or antibiotic needs.

Equipment

First of all, your goat should have a sturdy collar and leash. Nylon is best. If your goats have horns or are roaming free on pasture, it is a good idea to remove collars to avoid accidental strangling. For headstrong goats, a halter may work well. Sheep halters will fit goats, but you can also buy or order goat halters. These should never be left on unattended goats.

If you have a young goat (goats should not carry full pack weight until 1 1/2 to 2 years) you will want to start with a soft pack. These are similar to packs for dogs, in fact, dog packs work quite well. You can also purchase soft packs made especially for goats, or even make your own. These consist of fabric pouches slung over the goat's back, and a chest strap, rump strap and bell strap, usually made of nylon webbing.

For any serious packing, you will need a hard, or

cross buck pack. These are like the cross buck saddles for horse packing, only smaller. They are made of wood or aluminium with leather or nylon straps. You will also need a soft pad for under the saddle, and the bags, called panniers. In addition to the load in the panniers, items such as sleeping bags and tents etc. can be affixed to the top of the saddle using bungee cords. In the case of bad weather, some people cover the load with a small tarp called a *manty*. There are many variations on load carrying designs, including panniers specially built for water jugs, or for carrying hunted game.

Pack saddles are widely available on the Internet, or check around to see if anyone builds them locally. It is cheapest to order in an entire set (saddle, pad, panniers). Some people attempt to build their own, but this can be difficult as fit is extremely important to avoid back damage to the goat, and the angle of the cross buck must be exact.

Training Your Packer

If you purchase a young, untrained kid, it is up to you to raise him to be a willing, obedient packer. Buying a bottle raised or friendly dam-raised kid will save you much time as they will already be tame and want to be with you.

First, you must teach your kid to walk obediently on a leash. This of course will be more difficult if you are walking away from your goat's buddies, so start just walking around the pen. If you have lots of space away from roads, you can take your little babies out free, to get used to walking with you, and things like puddles, rocks, etc.

Goats learn much like dogs, through repetition and reward. It is a good idea to teach basic commands such as "giddyap", "whoa", "stand", and "no!". Goats will learn their names quickly if repeated often. Some people are against using food as rewards, and some swear by it. Use your own discretion. Food can be a powerful motivator, but there is nothing more annoying than a "pocket goat" who is constantly searching you for food when you are trying to set up the tent, build a fire, etc.

Deterrent methods for goats are varied. “No!” is a very important command for your goat to learn. It may be accompanied by a tug on the collar or a light slap on the nose to get the point across. For truly obnoxious goats, a spray from a water bottle in the face might do the trick. It is important for your goats, especially if he is horned, not to become the boss of people. In extreme cases, goats may need to be wrestled to the ground and sat on. My largest pack goats (weighing more than me by quite a bit) met this fate several times for threatening me (quite a work-out). It serves mostly as embarrassment. For campsite discipline, or when you are not close to your goat, a “shaker” may work well. This is a can or bottle filled with something noisy, like pennies or rocks. If a nosy goat is trying to unpack something he shouldn’t, a shaker thrown near him (not at) will often be discouraging.

Work your way up to weight slowly. A full pack on a goat who is not ready can cause permanent damage. Remember, goats often keep growing till 3-5 years. As well, condition your goat properly, just like you would train for a marathon run. Work your way up to long overnights or tough terrain. A well trained and conditioned goat makes hiking easier, safer and more fun for everyone.

At the Fair

Bringing your pack goat to the fair can be a new and exciting experience. While goats are common sights at country fairs, a goat wearing a saddle and halter is not! Even if you have no official pack goat classes, a fair is an excellent opportunity to educate the public about pack goats.

Classes:

As a 4-H member, your pack goat will be shown in two classes: conformation and fitting and showing (showmanship).

Conformation: Your goat will be judged on his conformation, or how well he is put together to do the job of packing. He will be compared to a standard designed to encompass features that will best serve a working pack goat. The scorecard consists of: structural correctness (40 points),

muscularity (30 points), attitude (20 points), and coordination (10 points). See the scorecard in the judging material in this manual.

Fitting and Showing: This class is judged more on the handler than the goat. The appearance of the handler, the evidence that they have put time in preparing their goat and the behaviour of the goat are all taken into consideration. As well, the goat will negotiate an obstacle course, and the handler will be required to answer questions. The scorecard consists of: exhibitor’s appearance (10 points), goat’s appearance (25 points), showing the goat (35 points), questions (15 points) and pack goat trail test (15 points). See the pack goat scorecard in the showmanship section of this manual.

Stall Decoration

Likely, your goat will be stalled with the other 4-H goats. Ask if you can have a bit of space for material promoting pack goats like posters you have made or brochures. If you are doing a demonstration, you may be allotted more space, in which case you can create an entire display, perhaps with photo albums, books or videos. You will find many people interested.

Demonstrations

If you have many pack goats or know other people who do, consider a demonstration for the fair. Talk to the demonstration coordinator at your fair. You will need separate stall space, and it may be hard to come by. Be prepared! A good demo takes lots of preparation and coordination: stall decorations, props, practising with others, stall duty, public speaking and of course, training your goats effectively. It is also lots of fun. Consider a parade entry as well!

Pack Goat Acknowledgements

Working with pack goats and being a part of 4-H have led to some of the most memorable, entertaining and treasured times of my life. Putting together this manual was a real learning experience,

and I couldn't have done it without the help of other members of the goat and pack goat community. I would like to thank them, and wish them all happy trails!

- Ian and Kathryn MacDonald, of Hoof 'n' It Pack Goats
- Donna Semasko and Liz Smith, authors of the 4-H Pack Goat Manual in the US
- Carolyn Eddy, author of "Practical Goatpacking"
- "All About Packgoats": Internet mailing list
- Cherry Bolduc of Mostly Mini Hobby Farm, my Self-Determined Project Leader and vast source of goat knowledge
- Gabriele and Wolf Wesle, pack goat hosts
- Karen Smith, pack goat host and judge at first ever Pack Goat Class in BC
- Kathy and John Watt (my parents) for donating hours of computer time and endless stacks of paper, as well as giving me my very first goats
- And last but not least, my pack goats (and Sue for giving them a good home): Roadrunner, Tam O'Shanter, Antic, Finnegan and Dexter (plus the parade of others I have cared for).

Thanks so much everyone!

Goat Glossary

A

Abomasum - The fourth compartment of a ruminant's stomach, where actual digestion takes place.

Afterbirth - The membranes of pregnancy that are expelled following parturition (giving birth).

Alpine - Swiss dairy goat breed. Erect ears. Various colours.

Amino Acids - Small compounds that are the building blocks of proteins.

Angora - A breed of goat having long, silky hair.

Animal abuse - Any act, omission or neglect that causes or permits unnecessary pain, suffering or death of animals.

Animal rights - Conditions, respect and fairness to which animals are justifiably entitled according to their natural characteristics.

Animal welfare - Human responsibility for the quality of animal life.

Antibiotic - Substance that prevents or controls infection.

Artificial Insemination - Method of breeding a doe using frozen semen instead of using a buck.

Auction - A sale where successive bids are received where an animal is sold to the highest bidder.

B

Bacteria - Large group of widely distributed one-celled microorganisms that may appear singly or in colonies as spherical, rod-shaped or spiral, thread-like cells.

Balanced daily ration - A combination of feeds that provide the essential nutrients. When given in specified amounts, it properly nourishes an animal for a 24-hour period.

Barn Records - A method of keeping milk records whereby the owner weighs and records the individual production of each milker in his herd.

Bloat - A swelling of the rumen caused by accumulation of gas. May be fatal if not released.

Breech birth or delivery - The birth of an animal with the buttocks or rear feet first rather than the head or front feet first.

Breed - A group of animals with common ancestry and characteristics.

Browsing - The preferred feeding pattern for goats. They cruise and nibble, eating an enormous variety of plants, brush, weeds, shrubbery and tree tips.

Brucellosis - A bacterial disease of domestic mammals caused by a bacillus that results in abortions; also called Bang's disease.

Buck - Male of the goat species.

Buck rag - Cloth rubbed on the scent glands of the buck and used to induce or detect heat in does.

By-product - An item of lesser value than the major product, for example, goat meat is a by-product

of dairy goat raised to give milk.

C

Caprine - Of or pertaining to

Caprine arthritic encephalitis (CAE) - A viral syndrome specific to goats that causes carpal arthritis and encyphilitis in kids.

Cashmere goat - The hair of a goat native to the Himalayan regions of India and Tibet and prized for its wool.

Castration - Stopping circulation or removing the male sexual organs.

Chevon - Goat meat (French)

Classification - A scorecard type system that evaluates goats against the ideal such as excellent or very good, based upon general appearance, dairy character, mammary system and body capacity.

Cloning - To create a genetic duplicate of an individual organism through asexual reproduction, as by stimulating a single cell.

Closebreeding - A form of inbreeding to the extent of mating closely related animals, e.g. dam to son.

Colostrum - The doe's first milk, rich in antibodies and vitamins needed by newborn kids to get off to a healthy start. It is secreted for up to 4 days after delivery.

Common or scrub - A goat animal of unknown ancestry.

Concentrate - Feeds low in fibre and supplying large amounts of digestible nutrients, e.g. cereal grains, oil meals.

Cow-hocked - Undesirable, crooked hind legs. Hocks too close together as viewed from behind.

Crimp - The waviness in a lock of mohair.

Goat Glossary

Crossbred - Offspring produced by the mating of two different breeds.

Crutching - Trimming the hair in an Angora doe's crotch (around the udder and tail) so that kidding is cleaner and the kid can find the teat more easily. (Angora goat)

Cryptorchidism - Undescended testicle(s).

Cud - A bolus or a soft mass of chewed food regurgitated from the stomach to the mouth in animals that are ruminants.

Culling - Eliminating substandard animals from the herd by butchering or selling them for meat.

Cyst - Pouch or sac filled with fluid or semisolid material.

D

Dam - The female goat parent, or mother.

Dehorning - Removing horns surgically.

Deworm - To rid of internal parasites.

D.H.A.S. - Dairy Herd Analysis System - A milk testing program offered by the Canadian Goat Society for group-production testing or owner-sampler.

Diet - A nutritionally balanced mixture of feed ingredients.

Digestibility - The percentage of a nutrient that is absorbed from the intestines as compared to what is eliminated as manure.

Digestion - The process whereby complex nutrients such as starch, fats and proteins are chemically broken down in the digestive system into

simple nutrients such as glucose, fatty acids and amino acids which can be absorbed and utilized by the body.

Disbudding - Stopping the growth of horns by burning with a very hot disbudding iron, before the horns have sprouted (3-5 days of age).

Doe - Female goat.

Doeling - Female goat less than one year of age.

Drench - A liquid medication; also, to administer a liquid medication.

Dry doe - Mature doe that is not lactating.

Dry off - Stopping the production of milk so the doe may have a rest before freshening and usually 8 weeks before she gives birth.

Dry period - The time when an animal is not producing milk. In a current lactation doe, the dry period is about 60 - 90 days before kidding.

Dystocia - Abnormal or difficult labour and/or birth.

E

Elf ear - LaMancha ear up to two inches long.

Emasculator - An instrument used for the bloodless castration of livestock. It cuts the spermatic cord without injury to the scrotum. Also called a burdizzo.

Embryo transplant - The removal of a developing embryo from one female and transfer to the uterus of another. It usually involves the superovulation of superior females and the eventual transfer of their embryos in an attempt to increase the number of superior offspring.

Energy - A product of carbohydrate and fat food nutrients that supplies the fuel the goat needs to walk, breathe, grow and keep warm. Energy food sources are corn, wheat, oats, barley, grasses and hay.

Estrus - The heat period that last one to three days every 21 days during the breeding season.

Estrus cycle - The reoccurring 15-21 day reproductive cycle of a doe from the time she is ready to be bred until she will be bred again if conception does not occur.

F

Feed - Food given to animals to provide them with essential nutrients.

Fertile - The stage of development of the female animal at which conception will occur.

First freshener - A doe that has kidded once.

Fitting - The clipping, washing and grooming of animals for show.

Fleece - The hair or wool of an animal.

Flush - To increase a doe's nutritional supply of energy and thereby stimulate ovulation and conception.

Foot rot - Fungus infection causing lameness.

Free choice - Method of feeding in which rations are always present.

Freshening - To begin lactation after giving birth.

Goat Glossary

G

Gene - The smallest unit of inheritance found as a part of chromosome.

Genetic engineering - The intentional altering of genes by humans, usually to prevent or eliminate hereditary defects.

Genotype - The genetic makeup of an animal.

Gestation - The period from conception (uniting of the egg & sperm) until birth of the offspring - approximately 145 - 155 days in goats.

Gopher Ear - LaMancha ear one inch long or less with cartilage.

Grade - A doe having one parent registered as a purebred and the other of mixed or unknown ancestry.

H

Hay - Livestock feed made from forage that has been cut and allowed to dry so that it may be stored without moulding.

Heart Girth - A "V" line around the body of an animal just behind the shoulders; a measurement that is sometimes used to estimate body weight.

Heat period - Estrus; the period during which a female is sexually receptive.

Herbivorous - Animals that live on plants and legumes and nurse their young with milk.

Herd - A group of animals, particularly cattle, horses, hogs or goats.

Heredity - The transfer of characteristics from one generation to another.

Herdsmanship - The caring and managing of a group of livestock; the organized display and cleanliness of a livestock exhibit.

Hormone - A chemical substance secreted into the body fluids by an endocrine gland that has a specific effect on other tissues.

Host - An animal upon which another organism lives as a parasite.

Human-animal bond - Emotional attachment between a person and non-human companion.

I

Implant - To insert or embed surgically, such as an embryo.

Inbreeding - The mating of closely related animals and includes closebreeding and linebreeding.

Inter-herd effects - Environmental effects that are different from herd to herd.

Intra-herd effects - Environmental effects that affect all animals within a herd in much the same manner in the same time period.

K

Kemp - Straight, chalky white, brittle hair; very undesirable. (Angora goat)

Ketosis - A metabolic disease characterized by excessive amounts of ketone bodies such as acetone in the blood and body fluids.

Kid - A goat under one year of age.

Kidding - Giving birth to young. Freshening.

L

Lactation - The period of time from which a doe freshens until she is dried off prior to kidding again.

LaMancha - American dairy goat breed of Spanish descent. Wide variety of colours. Very short or no external ears.

Linebreeding - A form of inbreeding but to only a minor degree, e.g. cousin to cousin mating.

M

Macro minerals - Minerals required by the goat in relatively large amounts because they make the largest percentage of minerals in the goat's body.

Mammary system - The udder, teats and tissues associated with milk secretion.

Manger - A trough that holds feed.

Mastitis - An inflammation of the mammary glands caused by microorganisms or injury.

Micro minerals - Sometimes called trace minerals because they are required in very small amounts by the goat.

Milk components - Usually refers to one or more of the three substances in milk that are considered to be (potential) bases for milk pricing; fat, protein and solids that are not fats.

Goat Glossary

Milk fever - A disease known to cows and goats that occurs at about the time of parturition that involves a slight generalized paralysis of the muscles; it is associated with a low level of calcium in the blood.

Milking parlour - A special facility in which cows or goats are brought to be milked.

Milk replacer - Milk substitute fed to the young goat instead of the dam's milk.

Minerals - Elements required by the goat to build bones and teeth and to support other life processes.

Mohair - The fleece or hair from an Angora goat.

N

Necropsy - A post-mortem examination of tissue or other material from a dead animal, usually for diagnosis.

Nubian - A breed of dairy goat with long, wide pendulous ears. Roman nose. Wide variety of colours.

Nutrient - A chemical substance that nourishes, such as protein, fat, carbohydrate, mineral or vitamin.

O

Oberhasli - Newest Swiss dairy goat breed. Erect ears, bay or red with black markings. All black does are acceptable.

Offspring - Animals born to a parent. Also, descendants, either first or later generations.

Oil meal - A kind of feed obtained from soybeans, cottonseed, flaxseed and certain other seeds after the oil has been removed and which contains relatively large amounts of protein.

Omasum - The third compartment of the ruminant stomach. It is located between the reticulum and the abomasum.

Open - Not carrying offspring.

Outcrossing - Mating of two unrelated animals within the same breed. This system will likely increase hybrid vigour and reproductive performance.

Oxytocin - A hormone of the posterior pituitary gland that functions in the release of milk from the mammary gland and aids in parturition, or giving birth.

P

Pack goat - Large goats of breeds or combination of breeds used to carry loads.

Palatability - The degree to which an animal will eat a feed depending if it is pleasant to the taste, smell, and feel.

Parasite - Internal or external organism which lives in and on the host animal at whose expense it obtains food and shelter.

Parrot mouth An undesirable, inherited, recessive condition in which the upper jaw extends beyond the lower jaw interfering with grazing and browsing.

Parturition - Giving birth to young.

Pasteurization - Process where milk is heated to 72 degrees Celsius for 15 seconds or to 63 degrees Celsius for 30 minutes to kill microorganisms that may transfer disease or cause milk to spoil. Names for Louis Pasteur, who discovered the process in 1856.

Pasture - Grasses or legumes grown for grazing animals.

Pedigree - A record of the male and female ancestors showing name, date of birth, and production figures.

Phenotype - The appearance of an animal or one of its traits; the way an animal looks or behaves as determined in part by the genotype.

Physiology - The study of the body and its organs, systems, tissues and cells.

Pneumonia - Inflammation (swelling) in the lungs that results in breathing difficulties.

Polled - An animal naturally hornless.

Pregnancy - The period during which an embryo or fetus is developing inside the uterus, or womb.

Progeny - Refers to offspring or descendants of an individual.

Protein - A class of food nutrient supplied by feed ingredients such as soybean oil meal and cottonseed oil meal to build body protein that makes muscle, bone, blood, skin and hair.

Protein supplement - An ingredient that supplies protein, vitamins and minerals to the goat.

Goat Glossary

Proven buck - A buck that has proven his ability to transmit his good qualities by consistently producing animals that are superior to their dams.

Puberty - The time when an animal becomes sexually mature. The female begins to cycle and is capable of becoming pregnant. In the male, sperm production begins in the testicles.

Purebred - An animal descended from a line of ancestors of the same breed; may or may not be registered.

R

Ration - The total feed intake of an animal in a 24-hour period.

Recessive - Refers to a gene whose expression can be modified or covered by an allele (any of a group of possible mutations of a gene) or a dominant gene.

Recorded grade - Animal recorded in a breed association herd book as having one registered.

Registration paper - Official record issued by Canadian Livestock Records as to the identity and pedigree of a purebred animal.

Rennet - Is an extract made from the lining of the fourth stomach of a cow or young goat. Rennet contains an enzyme called rennin which causes milk to form a solid curd.

Respiration - The act of inhaling and exhaling, usually 12 to 20 times per minute in goats.

Retained placenta - Fetal membranes that are not expelled following parturition, or giving birth.

Reticulum - The second compartment of the ruminant stomach.

Roughage - Feeds low in total nutrients and usually high in fibre content, e.g. hay, straw, silage.

Rumen - The largest and first compartment of ruminant stomach. The pouch involved with bloat.

Ruminant - Hoofed animals that chew cud and have complex three or four chambered stomachs.

Ruminate - To bring previously eaten food back into the mouth for further chewing. To chew cud.

S

Saanen - Swiss dairy goat breed. All white. Erect ears.

Scours - An abnormal diarrhea in animals.

Scrub - Animal of unknown breeding.

Scurs - Growths of horny tissue of various lengths and shapes, caused by incomplete disbudding or dehorning. They may break off causing bleeding and pain.

Senior milker - A doe that has kidded more than once.

Settle - Get pregnant; conceive.

Sheepy fleece - Undesirable mohair with wool-like qualities; also called spongy or woolly fleece.

Showmanship - The presentation of an animal at a show including proper fitting, showing procedure and exhibitor appearance.

Sire - The father of the offspring.

Social order - The tendency of animals to behave in an order of social dominance.

Somatic cell count - the number of somatic cells in milk provides an indication of mastitis problems.

Spongy fleece - Undesirable mohair with wool-like qualities; also called sheepy or woolly fleece.

Stained hair - Orange brown, urine-stained mohair.

Stanchion - A restraining device that holds a goat by the neck.

Standing heat - That part of estrus (estrous period) when the female is most receptive to the male.

Staple length - The length of individual locks of mohair.

Starter ration - The first feed other than milk a goat receives. May include equal parts cracked corn, crushed oats, wheat bran and about 10% soybean meal with minerals and vitamins added.

Stress - Abnormal or adverse conditions and factors to which an animal cannot adapt. The factors may be physical, chemical or psychological, resulting in physical tension and possible disease.

T

Tattoo - Ear identification markings to identify animals.

Toggenburg - Swiss dairy goat breed. Brown with white markings and erect ears.

Trace minerals - Any one of several mineral elements that are required by animals in very small amounts. Examples are iron, iodine, cobalt, copper, manganese.

Trait - Any observable feature or characteristic of an animal.

Trip - A group of goats can be called a trip.

Goat Glossary

Type - Referring to the structure, or conformation of an animal, or the type of product it produces. Examples are meat-type hog, wool-type sheep, milk or dairy-type goat.

U

Udder - Milk producing glands of the female.

Unrecorded grade - A doe whose ancestry is either unknown or not recorded.

V

Vaccine - A substance that contains live, modified or dead organisms or their products that is injected into an animal in an attempt to protect the host from a disease caused by that organism.

Vitamin - A class of food nutrient needed for the health of eyes, nasal passages, lungs, strong bones and blood clotting.

W

Warts - Growth on skin caused by infectious virus (germ).

Water - An important food nutrient used by the goat's body to carry away waste products, lubricate joints and serve as a built-in cooling system.

Wattles - Hair covered tassels appearing at the throat. They have no purpose.

Wether - A castrated buck.

Y

Yearling - An animal 12 to 24 months old.

Z

Zoonotic - Disease transferred from people to animals or vice versa.

B.C. 4-H Provincial Council

2743 – 30th Street

Vernon, B.C. V1T 5C6

Toll Free: 1-866-776-0373

Website: www.bc4h.bc.ca

